

Modern C++ Programming

1. INTRODUCTION

Federico Busato

2024-11-05

1 A Little History of C/C++ Programming Language

2 Areas of Application and Popularity

3 C++ Philosophy

4 C++ Weaknesses

- C++ Alternatives
- Why Switching to a New Language is Hard?

5 The Course

*“When recruiting research assistants, I look at grades as the last indicator. I find that **imagination, ambition, initiative, curiosity, drive,** are far better predictors of someone who will do useful work with me. Of course, these characteristics are themselves correlated with high grades, but there is something to be said about a student who decides that a given course is a waste of time and that he works on a side project instead.*

*Breakthroughs don't happen in regular scheduled classes, they happen in side projects. We want people who complete the work they were assigned, but **we also need people who can reflect critically on what is genuinely important**”*

Daniel Lemire, Prof. at the University of Quebec

Academic excellence is not a strong predictor of career excellence

“Across industries, research shows that the correlation between grades and job performance is modest in the first year after college and trivial within a handful of years...

*Academic grades rarely assess qualities like creativity, leadership and teamwork skills, or social, emotional and political intelligence. Yes, straight-A students master cramming information and regurgitating it on exams. But **career success is rarely about finding the right solution to a problem — it's more about finding the right problem to solve...**”*

*“Getting straight A’s requires conformity. **Having an influential career demands originality.***

This might explain why Steve Jobs finished high school with a 2.65 G.P.A., J.K. Rowling graduated from the University of Exeter with roughly a C average, and the Rev. Dr. Martin Luther King Jr. got only one A in his four years at Morehouse

*If your goal is to graduate without a blemish on your transcript, you end up taking easier classes and staying within your comfort zone. If you’re willing to tolerate the occasional B... **You gain experience coping with failures and setbacks, which builds resilience”***

“Straight-A students also miss out socially. More time studying in the library means less time to start lifelong friendships, join new clubs or volunteer...Looking back, I don’t wish my grades had been higher. If I could do it over again, I’d study less”

Adam Grant, *the New York Times*

“Got a 2.4 GPA my first semester in college. Thought maybe I wasn’t cut out for engineering. Today I’ve landing two spacecraft on Mars, and designing one for the moon.

*STEM is hard for everyone. Grades ultimately aren’t what matters.
Curiosity and persistence matter”*

***Ben Cichy**, Chief Software Engineer,
NASA Mars Science Laboratory*

“And programming computers was so fascinating. You create your own little universe, and then it does what you tell it to do”

Vint Cerf, TCP/IP co-inventor and Turing Award

“Most good programmers do programming not because they expect to get paid or get adulation by the public, but because it is fun to program”

Linus Torvalds, principal developer of the Linux kernel

“You might not think that programmers are artists, but programming is an extremely creative profession. It’s logic-based creativity”

John Romero, co-founder of id Software

Creativity *Programming is extremely creative. The ability to perceive the problem in a novel way, provide new and original solutions. Creativity allows recognizing and generating alternatives*

Form of Art *Art is the expression of human creative skills. Every programmer has his own style. Codes and algorithms show elegance and beauty in the same way as painting or music*

Learn *Programming gives the opportunity to learn new things every day, improve own skills and knowledge*

Challenge *Programming is a challenge. A challenge against yourself, the problem, and the environment*

Knowledge-Experience Relation

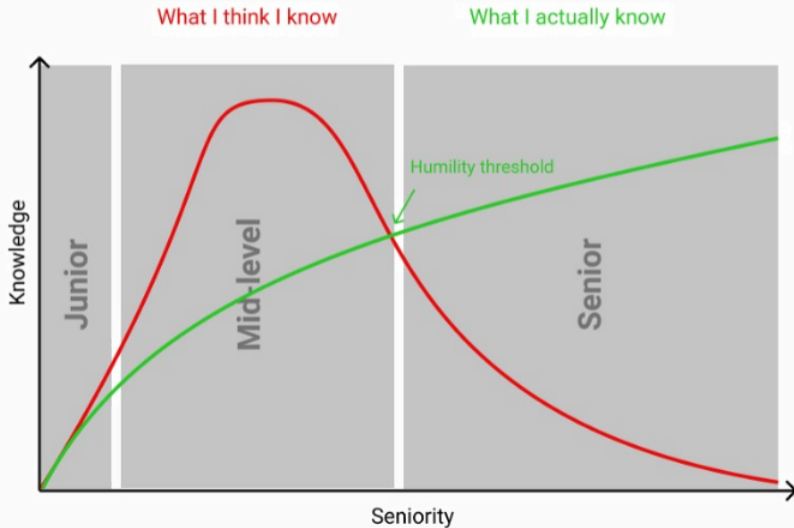

*“In software development, learning is not a big part of the job.
It is the job.”*

Woody Zuill

*“Programming is not about typing, **it’s about thinking.**”*

Rich Hickey

A Little History of C/C++ Programming Language

The Assembly Programming Language



A long time ago, in a galaxy far,
far away...there was **Assembly**

- Extremely simple instructions
- Requires lots of code to do simple tasks
- Can express anything your computer can do
- Hard to read, write
- ...redundant, boring programming, bugs proliferation

```
main:
.Lfunc_begin0:
    push rbp
.Lcfi0:
.Lcfi1:
    mov rbp, rsp
.Lcfi2:
    sub rsp, 16
    movabs rdi, .L.str
.Ltmp0:
    mov al, 0
    call printf
    xor ecx, ecx
    mov dword ptr [rbp - 4], eax
    mov eax, ecx
    add rsp, 16
    pop rbp
    ret
.Ltmp1:
.Lfunc_end0:
.L.str:
.asciz "Hello World\n"
```

In the 1969 **Dennis M. Ritchie** and **Ken Thompson** (AT&T, Bell Labs) worked on developing an operating system for a large computer that could be used by a thousand users. The new operating system was called **UNIX**

The whole system was still written in assembly code. Besides assembler and Fortran, UNIX also had an interpreter for the **programming language B**. A high-level language like B made it possible to write many pages of code task in just a few lines of code. In this way the code could be produced much faster than in assembly

A drawback of the B language was that it did not know data-types (everything was expressed in machine words). Another functionality that the B language did not provide was the use of “structures”. The lack of these things formed the reason for Dennis M. Ritchie to develop the **programming language C**. In 1988 they delivered the final standard definition ANSI C



Dennis M. Ritchie and Ken Thompson

```
#include "stdio.h"  
  
int main() {  
    printf("Hello World\n");  
}
```

Areas of Application:

- UNIX operating system
- Computer games
- Due to their power and ease of use, C were used in the programming of the special effects for Star Wars



Star Wars - The Empire Strikes Back

The **C++ programming language** (originally named “C with Classes”) was devised by **Bjarne Stroustrup** also an employee from Bell Labs (AT&T). Stroustrup started working on C with Classes in 1979. (The ++ is C language operator)

The first commercial release of the C++ language was in October 1985



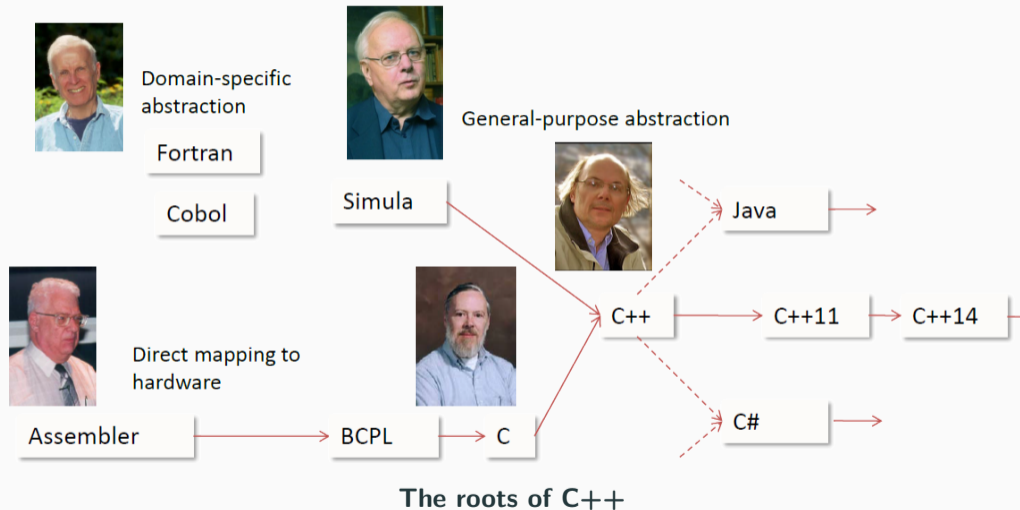

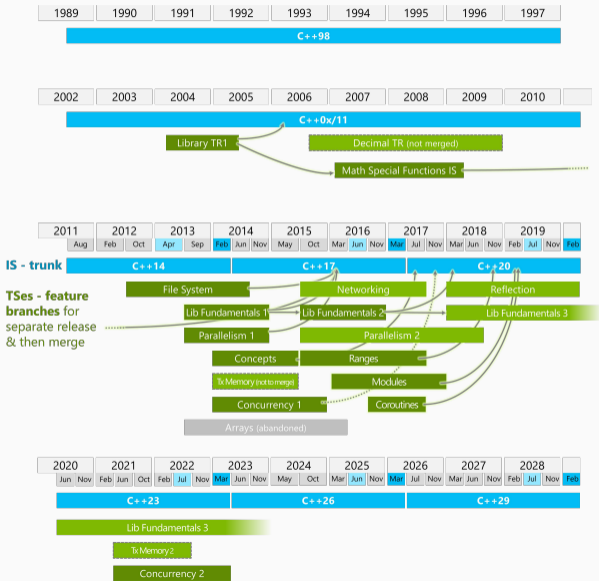

“If you’re teaching today what you were teaching five years ago, either the field is dead or you are”

Noam Chomsky







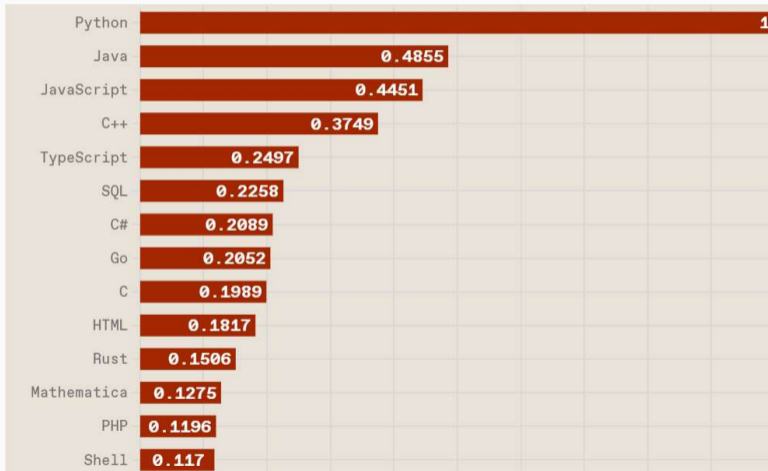

Areas of Application and Popularity

Most Popular Programming Languages (IEEE Spectrum - 2024)



Most Popular Programming Languages (TIOBE - October. 2024)

| Programming Language | | Ratings | Change |
|---|--------------|---------------|---------------|
|  | Python | 21.90% | +7.08% |
|  | C++ | 11.60% | +0.93% |
|  | Java | 10.51% | +1.59% |
|  | C | 8.38% | -3.70% |
|  | C# | 5.62% | -2.09% |
|  | JavaScript | 3.54% | +0.64% |
|  | Visual Basic | 2.35% | +0.22% |

Most Popular Programming Languages (Redmonk - June, 2021)

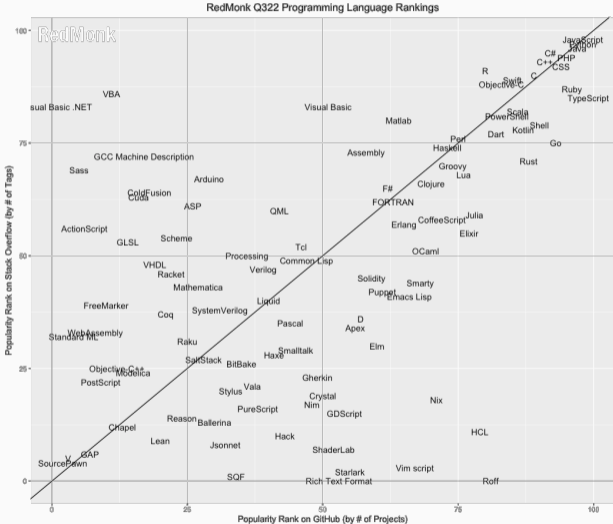

There may be more than 200 billion lines of C/C++ code globally

- **Performance is the defining aspect of C++.** No other programming language provides the performance-critical facilities of C++
- **Provide the programmer control over every aspect of performance**
- **Leave no room for a lower level language**

- **Ubiquity.** C++ can run from a low-power embedded device to large-scale supercomputers
- **Multi-Paradigm.** Allow writing efficient code without losing high-level abstraction
- **Allow writing low-level code.** Drivers, kernels, assembly (asm), etc.
- **Ecosystem.** Many support tools such as debuggers, memory checkers, coverage, static analysis, profiling, etc.
- **Maturity.** C++ has a 40 years history. Many software problems have been already addressed and developing practices have been investigated

- **Operating systems:** Windows, Android, OS X, Linux
- **Compilers:** LLVM, Swift compiler
- **Artificial Intelligence:** TensorFlow, Caffe, Microsoft Cognitive Toolkit
- **Image Editing:** Adobe Premier, Photoshop, Illustrator
- **Web browser:** Firefox, Chrome, etc. + WebAssembly
- **High-Performance Computing:** drug developing and testing, large scale climate models, physic simulations
- **Embedded systems:** IoT, network devices (e.g. GSM), automotive
- Google and Microsoft use C++ for web indexing

- **Scientific Computing:** CERN/NASA*, SETI@home, Folding@home
- **Database:** MySQL, ScyllaDB
- **Video Games:** Unreal Engine, Unity
- **Entertainment:** Movie rendering (see Interstellar black hole rendering), virtual reality
- **Finance:** electronic trading systems (Goldman, JPMorgan, Deutsche Bank)**

... and many more

* The flight code of the NASA Mars drone for the **Perseverance** Mission, as well as the **Webb telescope** software, are mostly written in C++ github.com/nasa/fprime, James Webb Space Telescope's Full Deployment

Why C++ is so Important?

The End of Historical Performance Scaling

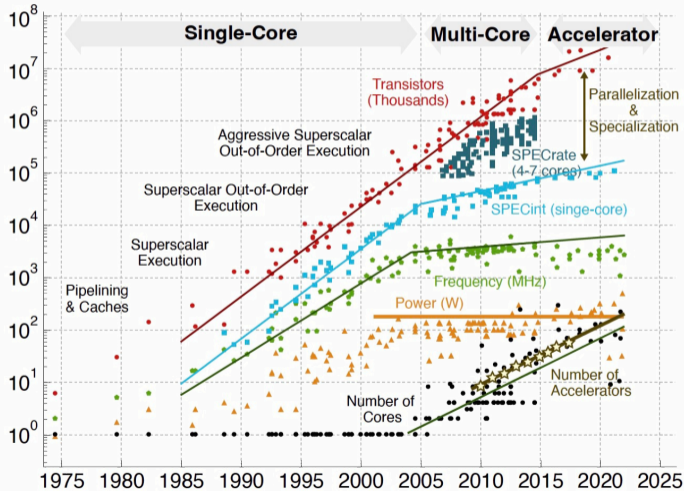

An Important Example... (AI Evolution)

Training compute (FLOP)

351 models

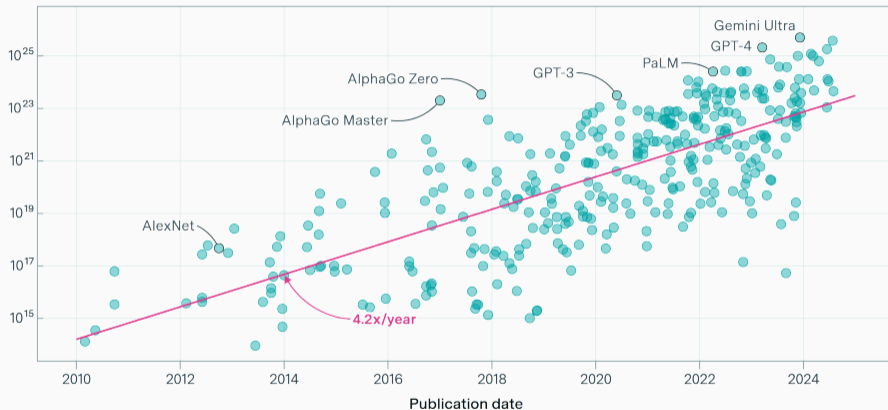

CC-BY

epochai.org

The Moore's Law is 1.4x per year

Notable AI Models [↗](#)

N-BODY SIMULATION

PROGRAMMING LANGUAGES PERFORMANCE COMPARISON

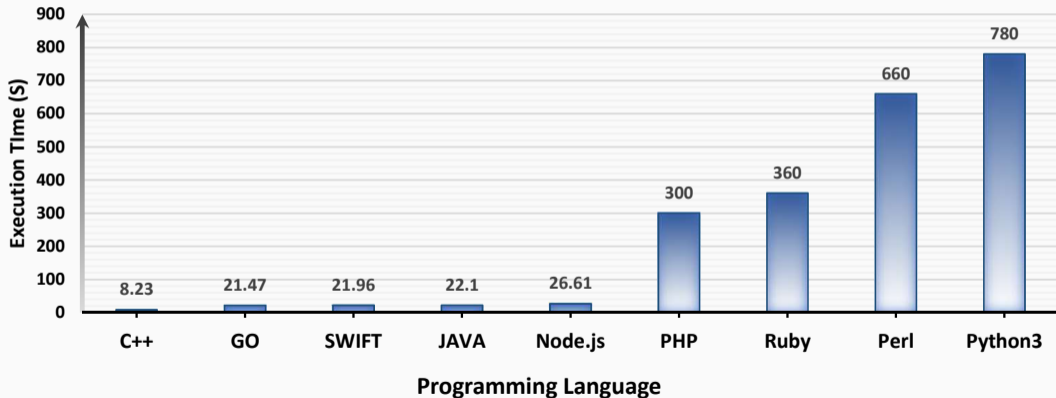

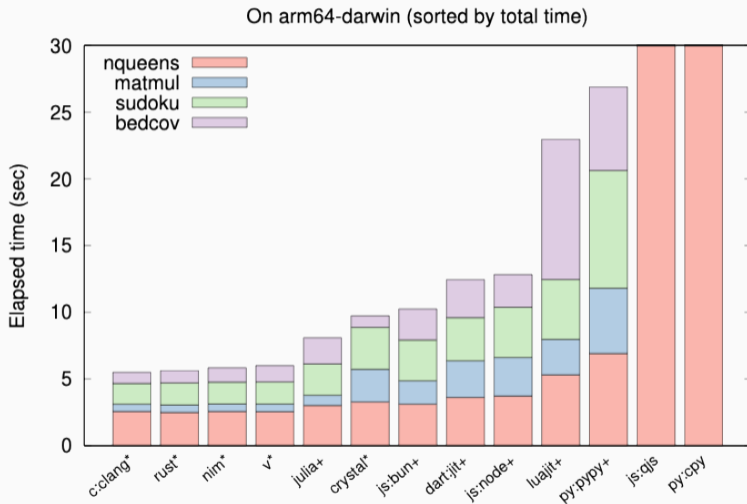

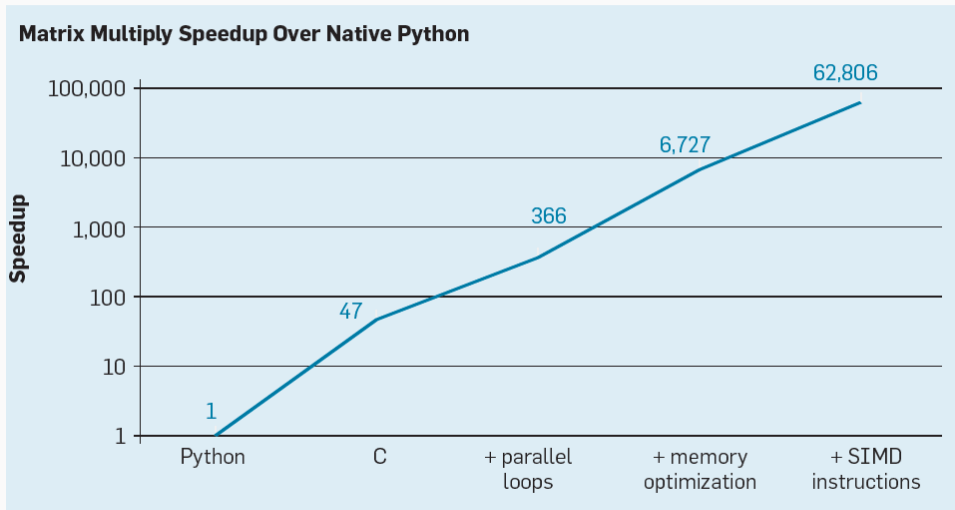

Hello World

| Language | Execution Time |
|-------------------|----------------|
| C (on my machine) | 0.7 ms |
| C | 2 ms |
| Go | 4 ms |
| Crystal | 8 ms |
| Shell | 10 ms |
| Python | 78 ms |
| Node | 110 ms |
| Ruby | 150 ms |
| jRuby | 1.4 s |

Performance/Expressiveness Trade-off

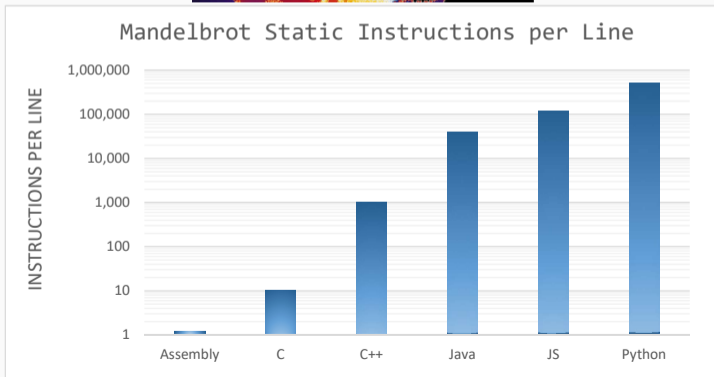
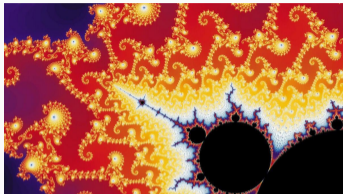

Memory Usage

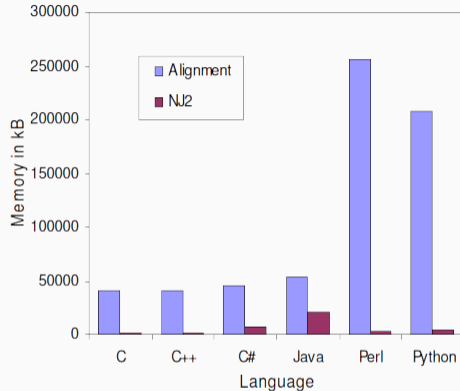

Memory usage comparison of the Neighbor-Joining and global alignment programs

A comparison of common programming languages used in bioinformatics (BMC Informatic)

Energy Efficiency

| | Energy | | Time |
|-------------|--------|----------------|-------|
| (c) C | 1.00 | (c) C | 1.00 |
| (c) Rust | 1.03 | (c) Rust | 1.04 |
| (c) C++ | 1.34 | (c) C++ | 1.56 |
| (c) Ada | 1.70 | (c) Ada | 1.85 |
| (v) Java | 1.98 | (v) Java | 1.89 |
| (c) Pascal | 2.14 | (c) Chapel | 2.14 |
| (c) Chapel | 2.18 | (c) Go | 2.83 |
| (v) Lisp | 2.27 | (c) Pascal | 3.02 |
| (c) Ocaml | 2.40 | (c) Ocaml | 3.09 |
| (c) Fortran | 2.52 | (v) C# | 3.14 |
| (c) Swift | 2.79 | (v) Lisp | 3.40 |
| (c) Haskell | 3.10 | (c) Haskell | 3.55 |
| (v) C# | 3.14 | (c) Swift | 4.20 |
| (i) Hack | 24.02 | (i) PHP | 27.64 |
| (i) PHP | 29.30 | (v) Erlang | 36.71 |
| (v) Erlang | 42.23 | (i) Jruby | 43.44 |
| (i) Lua | 45.98 | (i) TypeScript | 46.20 |
| (i) Jruby | 46.54 | (i) Ruby | 59.34 |
| (i) Ruby | 69.91 | (i) Perl | 65.79 |
| (i) Python | 75.88 | (i) Python | 71.90 |
| (i) Perl | 79.58 | (i) Lua | 82.91 |

CO₂ Production

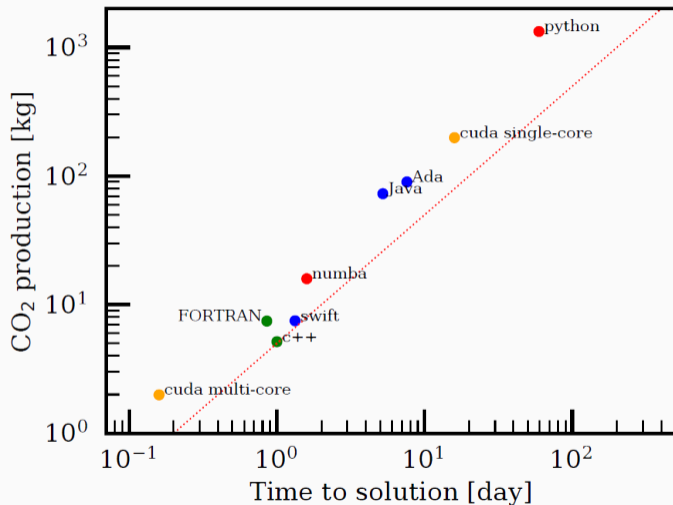

C++ Philosophy

*Do not sacrifice **performance** except as a last resort*

Zero Overhead Principle (zero-cost abstraction)

“it basically says if you have an abstraction it should not cost anything compared to write the equivalent code at lower level”

“so I have say a matrix multiply it should be written in a such a way that you could not drop to the C level of abstraction and use arrays and pointers and such and run faster”

Bjarne Stroustrup

*Enforce **safety at compile time** whenever possible*

Statically Typed Language

“The C++ compiler provides type safety and catches many bugs at compile time instead of run time (a critical consideration for many commercial applications.)”

www.python.org/doc/FAQ.html

- The *type annotation* makes the code more readable
- Promote compiler optimizations and runtime efficiency
- Allow users to define their own type system

- **Programming model:** *compartmentalization*, only add features if they solve an actual problem, and allow *full control*
- **Predictable runtime** (under constraints): no garbage collector, no dynamic type system → *real-time systems*
- **Low resources:** low memory and energy consumption → *restricted hardware platforms*
- **Well suited for static analysis** → *safety critical software*
- **Portability** → Modern C++ standards are highly portable

Who is C++ for?

“C++ is for people who want to use hardware very well and manage the complexity of doing that through abstraction”

Bjarne Stroustrup

“a language like C++ is not for everybody. It is generated via sharp and effective tool for professional basically and definitely for people who aim at some kind of precision”

Bjarne Stroustrup

Suggested Introduction Video



C++ Weaknesses

... and why teaching C++ as first programming language is a bad idea?

C++ is the hardest language from students to master

- *More languages in one*
 - Standard C/C++ programming
 - Preprocessor
 - Object-Oriented features
 - Templates and Meta-Programming
- *Huge set of features*
- *Worry about memory management*
- *Low-level implementation details:* pointer arithmetic, structure, padding, undefined behavior, etc.
- *Frustrating:* compiler/runtime errors (e.g. seg. fault)

“C makes it easy to shoot yourself in the foot; C++ makes it harder, but when you do, it blows your whole leg off”

Bjarne Stroustrup, Creator of the C++ language

“The problem with using C++...is that there's already a strong tendency in the language to require you to know everything before you can do anything”

Larry Wall, Creator of the Perl language

“Despite having 20 years of experience with C++, when I compile a non-trivial chunk of code for the first time without any error or warning, I am suspicious. It is not, usually, a good sign”

Daniel Lemire, Prof. at the University of Quebec

Backward-compatibility

“**Dangerous defaults and constructs**, often originating from C, cannot be removed or altered”

“Despite the hard work of the committee, **newer features sometimes have flaws that only became obvious after extensive user experience**, which cannot then be fixed”

“C++ practice has put an **ever-increasing cognitive burden** on the developer for what I feel has been very little gain in productivity or expressiveness and at a huge cost to code clarity”

C++ critics and replacements:

- Epochs: a backward-compatible language evolution mechanism
- Goals and priorities for C++
- Carbon Language
- Circle C++ Compiler
- Cppfront: Can C++ be 10x simpler & safer ... ?

C++ Alternatives: Rust

Rust (1.0, 2015) has been Stack Overflow's most loved language for eight years in a row. Rust focuses on performance and zero-abstraction overhead as C++. It is designed to prevent many vulnerabilities that affect C++, especially memory bugs, enforcing constraints at compile time. In addition, it promotes cross-platform compatibility

“First-time contributors to Rust projects are about 70 times less likely to introduce vulnerabilities than first-time contributors to C++ projects”

Tracey et al. ¹

¹ Grading on a Curve: How Rust can Facilitate New Contributors while Decreasing Vulnerabilities

- CISA, NSA: The Case for Memory Safe Roadmap
- Octoverse: The Fastest Growing Languages
- Secure by Design: Google's Perspective on Memory Safety

Zig (2016) is a minimal open-source programming language that can be intended as replacement of C. Zig supports compile time generics, reflection and evaluation, cross-compiling, and manual memory management. It is made to be fully interoperable with C and also includes a C/C++ compiler.

- **No perfect language.** There are always newer *'shining'* languages
- **Alignment.** Force all developers to switch to the new language
- **Interoperability.** Hundreds of billion lines of existing code. Must interoperate with C and C++ code imposing serious design constraints
- **Ecosystem.** Lack of tools and libraries developed in the last four decades
- **Time and Cost.** Converting a codebase of 10 million lines: 500 developers, 5 years, \$1,400,000,000¹

¹ Bjarne Stroustrup: Delivering Safe C++

▪ Performance overhead of safe programming languages

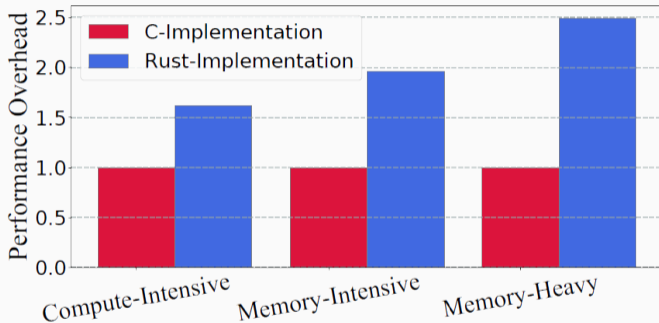

- Towards Understanding the Runtime Performance of Rust
- How much does Rust's bounds checking actually cost?
- How to avoid bounds checks in Rust (without unsafe!)
- Is coding in Rust as bad as in C++?



Lukasz Olejnik, Ph.D, LL.M

@lukOlejnik



There are 220bn lines of COBOL code in use today (1.5bn new lines/year). COBOL is the foundation of 43% of all banking systems. Such systems handle \$3 trillion of daily commerce. COBOL handles 95% of all ATM card-swipes, 80% of all in-person credit card transactions.

Every second spent trying to understand the language is one not spent understanding the problem

The Course

The Course

Days 1 - 10
Teach yourself variables, constants, arrays, strings, expressions, statements, functions,...



Days 11 - 21
Teach yourself program flow, pointers, references, classes, objects, inheritance, polymorphism,



Days 22 - 697
Do a lot of recreational programming. Have fun hacking but remember to learn from your mistakes.



Days 698 - 3648
Interact with other programmers. Work on programming projects together. Learn from them.



Days 3649 - 7781
Teach yourself advanced theoretical physics and formulate a consistent theory of quantum gravity.



Days 7782 - 14611
Teach yourself biochemistry, molecular biology, genetics,...



Day 14611
Use knowledge of biology to make an age-reversing potion.



Day 14611
Use knowledge of physics to build flux capacitor and go back in time to day 21.

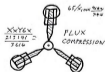

Day 21
Replace younger self.



As far as I know, this is the easiest way to "Teach Yourself C++ in 21 Days".

Don't forget: The right name of the course should be
“Introduction to Modern C++ Programming”

For many topics in the course, there are more than one book devoted to present the concepts in detail

The Course

The primary goal of the course is to drive who has previous experience with C/C++ and object-oriented programming to a proficiency level of (C++) programming

- *Proficiency*: know what you are doing and the related implications
- Understand what problems/issues address a given language feature
- Learn engineering practices (e.g. code conventions, tools) and hardware/software techniques (e.g. semantic, optimizations) that are not strictly related to C++

What the course **is**:

- A practical course, prefer examples to long descriptions
- A “quite” advanced C++ programming language course

What the course **is not**:

- A theoretical course on programming
- A high-level concept description

The Course

Organization:

- 26 lectures
- ~1,800 slides
- C++03 / C++11 / C++14 / C++17 / C++20 / (C++23) / (C++26)

Roadmap:

- Review C concepts in C++ (built-in types, memory management, preprocessing, etc.)
- Introduce object-oriented and template concepts
- Present how to organize the code and the main conventions
- C++ tool goals and usage (debugger, static analysis, etc.)

Federico Busato, Ph.D.

federico-busato.github.io



- **Senior Software Engineer at Nvidia,**
CUDA Core Compute Libraries
- Former lead of the Sparse Linear Algebra group
- Interests:
 - Sparse Linear Algebra
 - Graph Algorithms
 - Parallel/High-Performance Computing
 - Code Optimization



Follow @fedebusato

NOT a C++ expert/“guru”, still learning

A black and white photograph of Richard P. Feynman in a classroom or lecture hall. He is wearing a light-colored shirt and is captured in the middle of writing on a large chalkboard. His right arm is raised, holding a piece of chalk, and his left hand is also raised, possibly holding a piece of paper or another piece of chalk. The chalkboard is filled with complex mathematical equations and diagrams, including integrals and various symbols. The lighting is dramatic, with strong highlights on Feynman's shirt and the chalkboard, and deep shadows elsewhere. The overall atmosphere is one of intense intellectual activity.

***“What I cannot create,
I do not understand”***

***Richard P.
Feynman***

“The only way to learn a new programming language is by writing programs in it”

Dennis Ritchie

Creator of the C programming language

Modern C++ Programming

2. PREPARATION

Federico Busato

2024-11-05

1 Books and References

2 Slide Legend

3 What Editor/ IDE/Compiler Should I Use?

4 How to compile?

5 Hello World

- I/O Stream

Books and References

Suggested Books

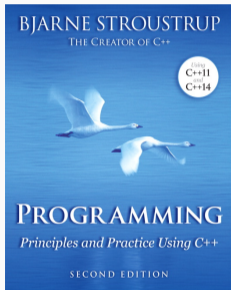

**Programming and Principles
using C++ (3rd, C++23)**
B. Stroustrup, 2024

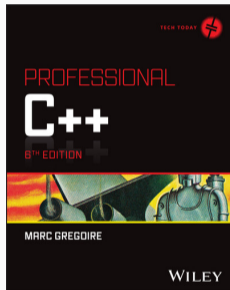

**Professional C++
(6th, C++23)**
S. J. Kleper, N. A. Solter, 2024

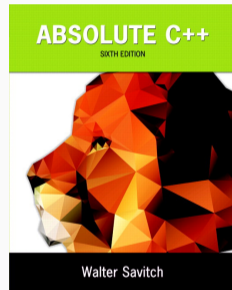

Absolute C++ (6th)
W. Savitch, 2015

More Advanced Books

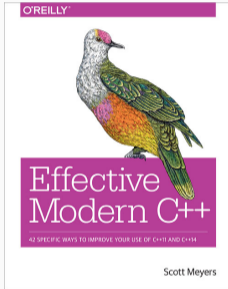

Effective Modern C++
S. Meyer, 2014



**Embracing Modern C++
Safely**
*J. Lakos, V. Romeo, R.
Khlebnikov, A. Meredith, 2021*

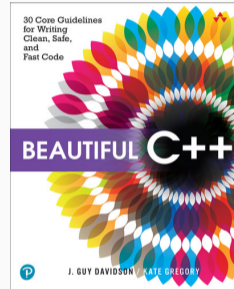

**Beautiful C++: 30 Core
Guidelines for Writing Clean,
Safe, and Fast Code**
J. G. Davidson, K. Gregory, 2021

(Un)official C++ reference:*

- en.cppreference.com ↗
- [C++ Standard Draft](#) ↗

Tutorials:

- [Learn C++](#) ↗
- [Tutorials Point C++](#) ↗
- en.wikibooks.org/wiki/C++ ↗
- [yet another insignificant...programming notes](#) ↗

Other resources:



- stackoverflow.com/questions/tagged/c++ ↗

* The full C++ standard draft can be found at eel.is/c++draft/full (32 MB!)



News:

- isocpp.org  (Standard C++ Foundation)
- [Reddit C++](#) 
- cpp.libhunt.com/newsletter/archive 
- [MeetingCpp Blogroll](#) 

Main conferences:

- cppcon.org  (slides), (search engine)
- meetingcpp.com  (slides)
- [isocpp.com conference list](#) 

Coding exercises:

- [HackerRank C++](#) 
- leetcode.com/problemset/algorithms 
- open.kattis.com 

Slide Legend

★ **Advanced Concepts.** *In general, they are not fundamental.* They can be related to very specific aspects of the language or provide a deeper exploration of C++ features.

A beginner reader should skip these sections/slides

↪ **See next.** C++ concepts are closely linked, and it is almost impossible to find a way to explain them without referring to future topics. These slides should be revisited after reading the suggested topic

🏠 **Homework.** The slide contains questions/exercises for the reader

```
this is a code section
```

This is a language `keyword/token` and not a program symbol (variable, functions, etc.). Future references to the token could use a standard code section for better readability

Parenthesis and Brackets

{ } **braces**, informally “curly brackets”

[] **brackets**, informally “square brackets”

() **parenthesis**, informally “round brackets”

< > **angle brackets**

What Editor/ IDE/Compiler Should I Use?

What Compiler Should I Use?

Most popular compilers:

- Microsoft Visual Code (**MSVC**) is the compiler offered by Microsoft
- The GNU Compiler Collection (**GCC**) contains the most popular C++ Linux compiler
- **Clang** is a C++ compiler based on LLVM Infrastructure available for Linux/Windows/Apple (default) platforms

Suggested compiler on Linux for beginner: **Clang**

- Comparable performance with GCC/MSVC and low memory usage
- Expressive diagnostics (examples and propose corrections)
- Strict C++ compliance. GCC/MSVC compatibility (inverse direction is not ensured)
- Includes very useful tools: memory sanitizer, static code analyzer, automatic formatting, linter, etc.

Install the Compiler on Linux

Install the last gcc/g++ (v14)

```
$ sudo add-apt-repository ppa:ubuntu-toolchain-r/test
$ sudo apt update
$ sudo apt install gcc-14 g++-14
$ gcc-14 --version
```

Install the last clang/clang++ (v19)

```
$ bash -c "$(wget -O - https://apt.llvm.org/llvm.sh)"
$ wget https://apt.llvm.org/llvm.sh
$ chmod +x llvm.sh
$ sudo ./llvm.sh 17
$ clang++ --version
```

Install the Compiler on Windows

Microsoft Visual Studio

- Direct Installer: Visual Studio Community 2022

Clang on Windows

Two ways:

- Windows Subsystem for Linux (WSL)
 - Run → optionalfeatures
 - Select Windows Subsystem for Linux, Hyper-V, Virtual Machine Platform
 - Run → ms-windows-store: → Search and install Ubuntu 24.04 LTS
- Clang + MSVC Build Tools
 - Download Build Tools per Visual Studio
 - Install Desktop development with C++

Popular C++ IDE (Integrated Development Environment):

- **Microsoft Visual Studio** (MSVC) ([link](#)). Most popular IDE for Windows
- **Clion** ([link](#)). (free for student). Powerful IDE with a lot of options
- **QT-Creator** ([link](#)). Fast (written in C++), simple
- **XCode**. Default on Mac OS
- **Cevelop** (Eclipse) ([link](#))

Standalone GUI-based coding editors:

- **Microsoft Visual Studio Code** (VSCode) ([link](#))
- **Sublime** ([link](#))
- **Lapce** ([link](#))
- **Zed** ([link](#))

Standalone text-based coding editors (powerful, but needs expertise):

- **Vim**
- **Emacs**
- **NeoVim** ([link](#))
- **Helix** ([link](#))

Not suggested: Notepad, Gedit, and other similar editors (lack of support for programming)

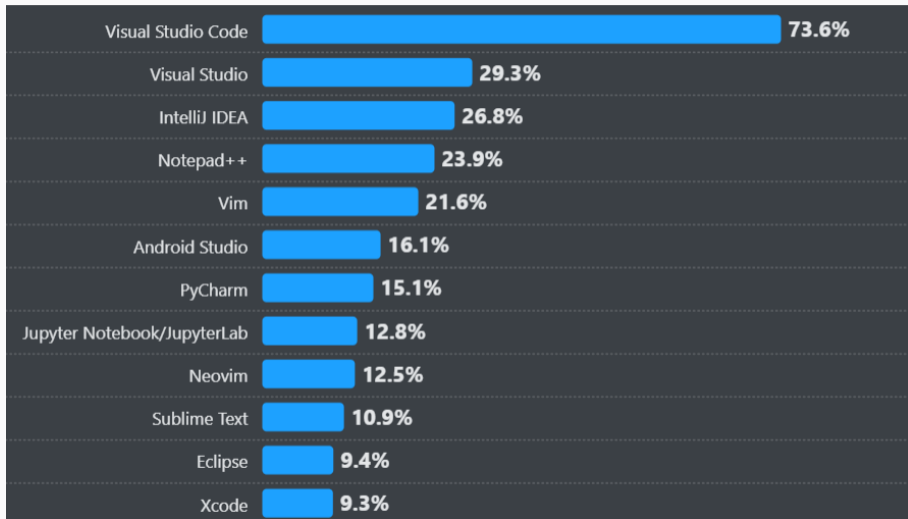

How to compile?

How to Compile?

Compile C++11, C++14, C++17, C++20, C++23, C++26 programs:

```
g++ -std=c++11 <program.cpp> -o program
g++ -std=c++14 <program.cpp> -o program
g++ -std=c++<version> <program.cpp> -o program
```

Any C++ standard is backward compatible*

C++ is also backward compatible with C in most case, except if it contains C++ keywords (new, template, class, typename, etc.)

We can potentially compile a pure C program in C++26

*except for very minor deprecated features

| Compiler | C++11 | | C++14 | | C++17 | | C++20 | |
|----------|-------|---------|-------|---------|-------|---------|--------|---------|
| | Core | Library | Core | Library | Core | Library | Core | Library |
| g++ | 4.8.1 | 5.1 | 5.1 | 5.1 | 7.1 | 9.0 | 11 | 14 |
| clang++ | 3.3 | 3.3 | 3.4 | 3.5 | 5.0 | 11.0 | 19+ | 19+ |
| MSVC | 19.0 | 19.0 | 19.10 | 19.0 | 19.15 | 19.15 | 19.29+ | 19.29 |

C++23, C++26 are working in progress

Hello World

C code with `printf` :

```
#include <stdio.h>

int main() {
    printf("Hello World!\n");
}
```

`printf`

prints on standard output

C++ code with `streams` :

```
#include <iostream>

int main() {
    std::cout << "Hello World!\n";
}
```

`cout`

represents the standard output stream

The previous example can be written with the global `std` namespace:

```
#include <iostream>

using namespace std;

int main() {
    cout << "Hello World!\n";
}
```

Note: For sake of space and for improving the readability, we intentionally omit the `std` namespace in most slides

`std::cout` is an example of *output* stream. Data is redirected to a destination, in this case the destination is the standard output

C:

```
#include <stdio.h>
int main() {
    int    a    = 4;
    double b    = 3.0;
    char   c[]  = "hello";
    printf("%d %f %s\n", a, b, c);
}
```

C++:

```
#include <iostream>
int main() {
    int    a    = 4;
    double b    = 3.0;
    char   c[]  = "hello";
    std::cout << a << " " << b << " " << c << "\n";
}
```

- **Type-safe:** The type of object provided to the I/O stream is known statically by the compiler. In contrast, `printf` uses `%` fields to figure out the types dynamically
- **Less error prone:** With I/O Stream, there are no redundant `%` tokens that have to be consistent with the actual objects passed to I/O stream. Removing redundancy removes a class of errors
- **Extensible:** The C++ I/O Stream mechanism allows new user-defined types to be passed to I/O stream without breaking existing code
- **Comparable performance:** If used correctly may be faster than C I/O (`printf`, `scanf`, etc.) .

- Forget the number of parameters:

```
printf("long phrase %d long phrase %d", 3);
```

- Use the wrong format:

```
int a = 3;  
...many lines of code...  
printf(" %f", a);
```

- The `%c` conversion specifier does not automatically skip any leading white space:

```
scanf("%d", &var1);  
scanf(" %c", &var2);
```

std::print

C++23 introduces an improved version of `printf` function `std::print` based on *formatter strings* that provides all benefits of C++ stream and is less verbose

```
#include <print>

int main() {
    std::print("Hello World! {}, {}, {}\n", 3, 411, "aa");
    // print "Hello World! 3 4 aa"
}
```

This will be the default way to print when the C++23 standard is widely adopted

Modern C++ Programming

2. BASIC CONCEPTS I

TYPE SYSTEM, FUNDAMENTAL TYPES, AND OPERATORS

Federico Busato

2024-11-05

1 The C++ Type System

- Type Categories
- Type Properties ★

2 Fundamental Types Overview

- Arithmetic Types
- Suffix and Prefix
- Non-Standard Arithmetic Types
- void Type
- `nullptr`

3 Conversion Rules

4 auto Keyword

5 C++ Operators

- Operators Precedence
- Prefix/Postfix Increment/Decrement Semantic
- Assignment, Compound, and Comma Operators
- Spaceship Operator `<=>` ★
- Safe Comparison Operators ★

The C++ Type System

The C++ Type System

C++ is a **strongly typed** and **statically typed** language

Every entity has a type and that type never changes

Every variable, function, or expression has a **type** in order to be compiled. Users can introduce new types with `class` or `struct`

The **type** specifies:

- The *amount of memory* allocated for the variable (or expression result)
- The *kinds of values* that may be stored and how the compiler interprets the bit patterns in those values
- The *operations* that are permitted for those entities and provides semantics

Type Categories

C++ organizes the language types in two main categories:

- **Fundamental types** (often called *primitive types*): Types provided by the language itself and don't require additional headers
 - *Arithmetic types*: integer and floating point
 - `void`
 - `nullptr` C++11
- **Compound types**: Composition or references to other types
 - Pointers
 - References
 - Enumerators
 - Arrays
 - `struct`, `class`, `union`
 - Functions

C++ types can be also classified based on their properties:

- **Objects:**

- *size*: `sizeof` is defined
- *alignment requirement*: `alignof` is defined
- *storage duration*: describe when an object is allocated and deallocated
- *lifetime*, bounded by storage duration or temporary
- *value*, potentially indeterminate
- optionally, a *name*.

Types: Arithmetic, Pointers and `nullptr`, Enumerators, Arrays, `struct`,
`class`, `union`

- **Scalar:**

- *Hold a single value* and is not composed of other objects
- *Trivially Copyable*: can be copied bit for bit
- *Standard Layout*: compatible with C functions and structs
- *Implicit Lifetime*: no user-provided constructor or destructor

Types: Arithmetic, Pointers and `nullptr` , Enumerators

- **Trivial types**: Trivial default/copy constructor, copy assignment operator, and destructor → *Trivially Copyable*

Types: Scalar, trivial class types, arrays of such types

- **Incomplete types**: A type that has been declared but not yet defined

Types: `void` , incompletely-defined object types, e.g. `struct A;` , array of elements of incomplete type

C++ Types Summary

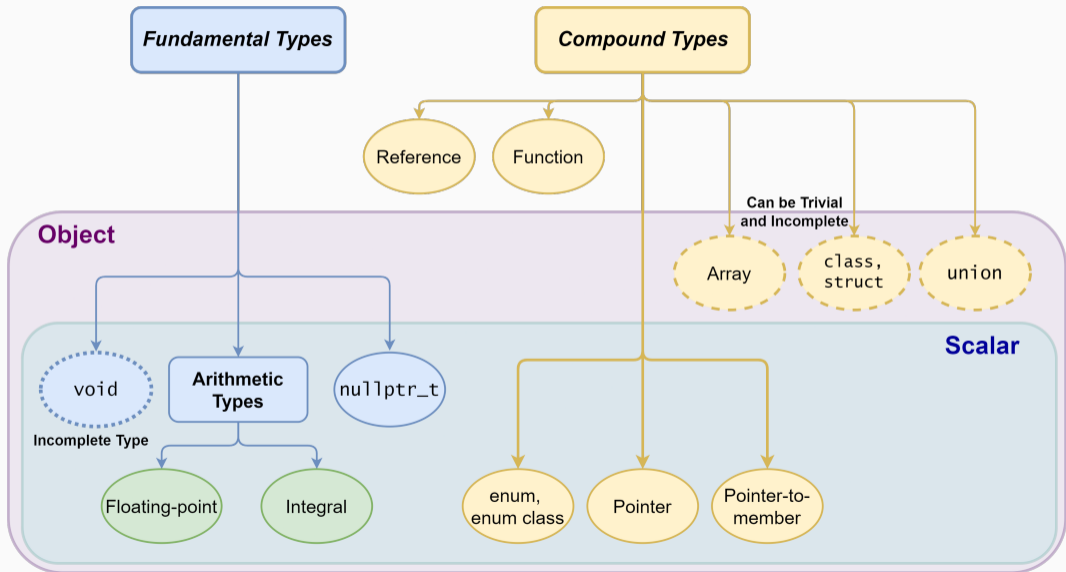

Fundamental Types

Overview

Arithmetic Types - Integral

| Native Type | Bytes | Range | Fixed width types |
|------------------------|-------|-------------------------|-------------------|
| | | | <stdint.h> |
| bool | 1 | true, false | |
| char † | 1 | implementation defined | |
| signed char | 1 | -128 to 127 | int8_t |
| unsigned char | 1 | 0 to 255 | uint8_t |
| short | 2 | -2^{15} to $2^{15}-1$ | int16_t |
| unsigned short | 2 | 0 to $2^{16}-1$ | uint16_t |
| int | 4 | -2^{31} to $2^{31}-1$ | int32_t |
| unsigned int | 4 | 0 to $2^{32}-1$ | uint32_t |
| long int | 4/8 | | int32_t/int64_t |
| long unsigned int | 4/8* | | uint32_t/uint64_t |
| long long int | 8 | -2^{63} to $2^{63}-1$ | int64_t |
| long long unsigned int | 8 | 0 to $2^{64}-1$ | uint64_t |

* 4 bytes on Windows64 systems, † signed/unsigned, two-complement from C++11

Arithmetic Types - Floating-Point

| Native Type | IEEE | Bytes | Range | Fixed width types C++23 <code><stdfloat></code> |
|-------------|------|-------|---|--|
| (bfloat16) | N | 2 | $\pm 1.18 \times 10^{-38}$ to $\pm 3.4 \times 10^{+38}$ | <code>std::bfloat16_t</code> |
| (float16) | Y | 2 | 0.00006 to 65,536 | <code>std::float16_t</code> |
| float | Y | 4 | $\pm 1.18 \times 10^{-38}$ to $\pm 3.4 \times 10^{+38}$ | <code>std::float32_t</code> |
| double | Y | 8 | $\pm 2.23 \times 10^{-308}$ to $\pm 1.8 \times 10^{+308}$ | <code>std::float64_t</code> |

Arithmetic Types - Short Name

| Signed Type | short name |
|----------------------|------------|
| signed char | / |
| signed short int | short |
| signed int | int |
| signed long int | long |
| signed long long int | long long |

| Unsigned Type | short name |
|------------------------|--------------------|
| unsigned char | / |
| unsigned short int | unsigned short |
| unsigned int | unsigned |
| unsigned long int | unsigned long |
| unsigned long long int | unsigned long long |

Arithmetic Types - Suffix (Literals)

| Type | SUFFIX | Example | Notes |
|-------------------------------------|-----------------------|-------------------|----------------------|
| <code>int</code> | <code>/</code> | <code>2</code> | |
| <code>unsigned int</code> | <code>u, U</code> | <code>3u</code> | |
| <code>long int</code> | <code>l, L</code> | <code>8L</code> | |
| <code>long unsigned</code> | <code>ul, UL</code> | <code>2ul</code> | |
| <code>long long int</code> | <code>ll, LL</code> | <code>4ll</code> | |
| <code>long long unsigned int</code> | <code>ull, ULL</code> | <code>7ULL</code> | |
| <code>float</code> | <code>f, F</code> | <code>3.0f</code> | only decimal numbers |
| <code>double</code> | | <code>3.0</code> | only decimal numbers |

| C++23 Type | SUFFIX | Example | Notes |
|------------------------------|-------------------------|----------------------|----------------------|
| <code>std::bfloat16_t</code> | <code>bf16, BF16</code> | <code>3.0bf16</code> | only decimal numbers |
| <code>std::float16_t</code> | <code>f16, F16</code> | <code>3.0f16</code> | only decimal numbers |
| <code>std::float32_t</code> | <code>f32, F32</code> | <code>3.0f32</code> | only decimal numbers |
| <code>std::float64_t</code> | <code>f64, F64</code> | <code>3.0f64</code> | only decimal numbers |
| <code>std::float128_t</code> | <code>f128, F128</code> | <code>3.0f128</code> | only decimal numbers |

Arithmetic Types - Prefix (Literals)

| Representation | PREFIX | Example |
|----------------|----------|----------|
| Binary C++14 | 0b | 0b010101 |
| Octal | 0 | 0307 |
| Hexadecimal | 0x or 0X | 0xFFA010 |

C++14 also allows *digit separators* for improving the readability `1'000'000`

Other Arithmetic Types

- C++ also provides `long double` (no IEEE-754) of size 8/12/16 bytes depending on the implementation
- Reduced precision floating-point supports before C++23:
 - Some compilers provide support for *half* (16-bit floating-point) (GCC for ARM: `__fp16`, LLVM compiler: `half`)
 - Some modern CPUs and GPUs provide *half* instructions
 - Software support: OpenGL, Photoshop, Lightroom, `half.sourceforge.net`
- C++ does not provide **128-bit integers** even if some architectures support it. `clang` and `gcc` allow 128-bit integers as compiler extension (`__int128`)

void Type

`void` is an incomplete type (not defined) without a value

- `void` indicates also a function with no return type or no parameters
e.g. `void f()`, `f(void)`
- In C `sizeof(void) == 1` (GCC), while in C++ `sizeof(void)` does not compile!!

```
int main() {  
    // sizeof(void); // compile error  
}
```

nullptr Keyword

C++11 introduces the keyword `nullptr` to represent a null pointer (`0x0`) and replacing the `NULL` macro

`nullptr` is an object of type `nullptr_t` → safer

```
int* p1 = NULL;    // ok, equal to int* p1 = 0l
int* p2 = nullptr; // ok, nullptr is convertible to a pointer

int  n1 = NULL;    // ok, we are assigning 0 to n1
//int n2 = nullptr; // compile error nullptr is not convertible to an integer

//int* p2 = true ? 0 : nullptr; // compile error incompatible types
```

Conversion Rules

Conversion Rules

Implicit type conversion rules, applied in order, before any operation:

⊗: any operation (*, +, /, -, %, etc.)

(A) Floating point promotion

`floating_type` ⊗ `integer_type` → `floating_type`

(B) Implicit integer promotion

`small_integral_type` := any signed/unsigned integral type smaller than `int`

`small_integral_type` ⊗ `small_integral_type` → `int`

(C) Size promotion

`small_type` ⊗ `large_type` → `large_type`

(D) Sign promotion

`signed_type` ⊗ `unsigned_type` → `unsigned_type`

Examples and Common Errors

```
float    f = 1.0f;
unsigned u = 2;
int      i = 3;
short    s = 4;
uint8_t  c = 5; // unsigned char

f * u; // float × unsigned → float: 2.0f
s * c; // short × unsigned char → int: 20
u * i; // unsigned × int → unsigned: 6u
+c;    // unsigned char → int: 5
```

Integers are not floating points!

```
int  b = 7;
float a = b / 2; // a = 3 not 3.5!!
int  c = b / 2.0; // again c = 3 not 3.5!!
```

Implicit Promotion

Integral data types smaller than 32-bit are *implicitly* promoted to `int`, independently if they are *signed* or *unsigned*

- Unary `+`, `-`, `~` and Binary `+`, `-`, `&`, etc. promotion:

```
char a = 48;      // '0'
cout << a;        // print '0'
cout << +a;       // print '48'
cout << (a + 0);  // print '48'

uint8_t a1 = 255;
uint8_t b1 = 255;
cout << (a1 + b1); // print '510' (no overflow)
```

auto **Keyword**

C++11 The `auto` keyword specifies that the type of the variable will be automatically deduced by the compiler (from its initializer)

```
auto a = 1 + 2;    // 1 is int, 2 is int, 1 + 2 is int!  
//    -> 'a' is "int"  
auto b = 1 + 2.0; // 1 is int, 2.0 is double. 1 + 2.0 is double  
//    -> 'b' is "double"
```

`auto` can be very useful for maintainability and for hiding complex type definitions

```
for (auto i = k; i < size; i++)  
    ...
```

On the other hand, it may make the code less readable if excessively used because of type hiding

Example: `auto x = 0;` in general makes no sense (`x` is `int`)

In C++11/C++14, `auto` (as well as `decltype`) can be used to define function output types

```
auto g(int x) -> int { return x * 2; } // C++11
// "-> int" is the deduction type
// a better way to express it is:

auto g2(int x) -> decltype(x * 2) { return x * 2; } // C++11

auto h(int x) { return x * 2; } // C++14

//-----

int x = g(3); // C++11
```

In C++20, `auto` can be also used to define function input

```
void f(auto x) {}  
// equivalent to templates but less expensive at compile-time  
  
//-----  
  
f(3);    // 'x' is int  
f(3.0); // 'x' is double
```

C++ Operators

Operators Overview

| Precedence | Operator | Description | Associativity |
|------------|--------------------------------------|--|---------------|
| 1 | a++ a-- | Suffix/postfix increment and decrement | Left-to-right |
| 2 | +a -a ++a --a ! not ~ | Plus/minus, Prefix increment/decrement, Logical/Bitwise Not | Right-to-left |
| 3 | a*b a/b a%b | Multiplication, division, and remainder | Left-to-right |
| 4 | a+b a-b | Addition and subtraction | Left-to-right |
| 5 | << >> | Bitwise left shift and right shift | Left-to-right |
| 6 | < <= > >= | Relational operators | Left-to-right |
| 7 | == != | Equality operators | Left-to-right |
| 8 | & | Bitwise AND | Left-to-right |
| 9 | ^ | Bitwise XOR | Left-to-right |
| 10 | | Bitwise OR | Left-to-right |
| 11 | && and | Logical AND | Left-to-right |
| 12 | or | Logical OR | Left-to-right |
| 13 | = += -= *= /= %= <<= >>= &= ^= = | Assignment and Compound operators | Right-to-left |

Operators precedence ↗:

- **Unary** operators have higher precedence than **binary operators**
- **Standard math operators** (+, *, etc.) have higher precedence than **comparison, bitwise, and logic** operators
- **Bitwise** and **logic** operators have higher precedence than **comparison** operators
- **Bitwise** operators have higher precedence than **logic** operators
- **Compound assignment** operators `+=`, `-=`, `*=`, `/=`, `%=`, `^=`, `!=`, `&=`, `>>=`, `<<=` have lower priority
- The **comma** operator has the lowest precedence (see next slides)

Examples:

```
a + b * 4;           // a + (b * 4)
a * b / c % d;      // ((a * b) / c) % d
a + b < 3 >> 4;      // (a + b) < (3 >> 4)
a && b && c || d;      // (a && b && c) || d
a and b and c or d; // (a && b && c) || d
a | b & c || e && d; // ((a | (b & c)) || (e && d))
```

Important: sometimes parenthesis can make an expression verbose... but they can help!

Prefix/Postfix Increment Semantic

Prefix Increment/Decrement `++i` , `--i`

- (1) Update the value
- (2) Return the new (updated) value

Postfix Increment/Decrement `i++` , `i--`

- (1) Save the old value (temporary)
- (2) Update the value
- (3) Return the old (original) value

Prefix/Postfix increment/decrement semantic applies not only to built-in types but also to objects

Operation Ordering Undefined Behavior ★

Expressions with undefined (implementation-defined) behavior:

```
int i = 0;
i = ++i + 2;      // until C++11: undefined behavior
                  // since C++11: i = 3

i = 0;
i = i++ + 2;     // until C++17: undefined behavior
                  // since C++17: i = 3

f(i = 2, i = 1); // until C++17: undefined behavior
                  // since C++17: i = 2

i = 0;
a[i] = ++i;     // until C++17: undefined behavior
                  // since C++17: a[1] = 1

f(++i, ++i);    // undefined behavior
i = ++i + i++;  // undefined behavior
```

Assignment, Compound, and Comma Operators

Assignment and **compound assignment** operators have *right-to-left associativity* and their expressions return the assigned value

```
int y = 2;
int x = y = 3; // y=3, then x=3
               // the same of x = (y = 3)
if (x = 4)     // assign x=4 and evaluate to true
```

The **comma operator**★ has *left-to-right associativity*. It evaluates the left expression, discards its result, and returns the right expression

```
int a = 5, b = 7;
int x = (3, 4); // discards 3, then x=4
int y = 0;
int z;
z = y, x;      // z=y (0), then returns x (4)
```

Spaceship Operator `<=>` ★

C++20 provides the **three-way comparison operator** `<=>`, also called *spaceship operator*, which allows comparing two objects similarly of `strcmp`. The operator returns an object that can be directly compared with a positive, 0, or negative integer value

```
(3 <=> 5)      == 0; // false
('a' <=> 'a') == 0; // true

(3 <=> 5)      < 0; // true
(7 <=> 5)      < 0; // false
```

The semantic of the *spaceship operator* can be extended to any object (see next lectures) and can greatly simplify the comparison operators overloading

Safe Comparison Operators ★

C++20 introduces a set of functions `<utility>` to safely compare integers of different types (signed, unsigned)

```
bool cmp_equal(T1 a, T2 b)
bool cmp_not_equal(T1 a, T2 b)
bool cmp_less(T1 a, T2 b)
bool cmp_greater(T1 a, T2 b)
bool cmp_less_equal(T1 a, T2 b)
bool cmp_greater_equal(T1 a, T2 b)
```

example:

```
#include <utility>
unsigned a = 4;
int      b = -3;
bool     v1 = (a > b);           // false!!!, see next slides
bool     v2 = std::cmp_greater(a, b); // true
```

Modern C++ Programming

3. BASIC CONCEPTS II

INTEGRAL AND FLOATING-POINT TYPES

Federico Busato

2024-11-05

1 Integral Data Types

- Fixed Width Integers
- `size_t`
- `ptrdiff_t` ★
- `uintptr_t` ★
- Arithmetic Operation Semantics
- Promotion, Truncation
- Undefined Behavior
- Saturation Arithmetic ★

2 Floating-point Types and Arithmetic

- IEEE Floating-point Standard and Other Representations
- Normal/Denormal Values
- Infinity (∞)
- Not a Number (NaN)
- Machine Epsilon
- Units at the Last Place (ULP)
- Cheatsheet
- Limits and Useful Functions

Table of Contents

- Arithmetic Properties
- Special Values Behavior
- Floating-Point Undefined Behavior
- Detect Floating-point Errors ★

3 Floating-point Issues

- Catastrophic Cancellation
- Floating-point Comparison

Integral Data Types

A Firmware Bug

“Certain SSDs have a firmware bug causing them to irrecoverably fail after exactly 32,768 hours of operation. SSDs that were put into service at the same time will fail simultaneously, so RAID won’t help”

HPE SAS Solid State Drives - Critical Firmware Upgrade





The latest news from Google AI

Extra, Extra - Read All About It: Nearly All Binary Searches and Mergesorts are Broken

Friday, June 2, 2006

Posted by Joshua Bloch, Software Engineer

Note: Computing the average in the right way is not trivial, see `On finding the average of two unsigned integers without overflow`

related operations: ceiling division, rounding division

Potentially Catastrophic Failure



$$51 \text{ days} = 51 \cdot 24 \cdot 60 \cdot 60 \cdot 1000 = 4\,406\,400\,000 \text{ ms}$$

Boeing 787s must be turned off and on every 51 days to prevent 'misleading data' being shown to pilots

| C++ Data Model | OS | Number of Bits | | | | |
|-----------------------|-------------------|----------------|-----|-----------|-----------|---------|
| | | short | int | long | long long | pointer |
| ILP32 | Windows/Unix 32-b | 16 | 32 | 32 | 64 | 32 |
| LLP64 | Windows 64-bit | 16 | 32 | <u>32</u> | 64 | 64 |
| LP64 | Linux 64-bit | 16 | 32 | <u>64</u> | 64 | 64 |

`char` is always 1 byte

LP32: Windows 16-bit APIs (no more used)

```
int*_t <cstdint>
```

C++11 provides fixed width integer types.

They have the same size on any architecture:

`int8_t`, `uint8_t`

`int16_t`, `uint16_t`

`int32_t`, `uint32_t`

`int64_t`, `uint64_t`

Good practice: Prefer fixed-width integers instead of native types. `int` and `unsigned` can be directly used as they are widely accepted by C++ data models

`int*_t` types are not “real” types, they are merely *typedefs* to appropriate fundamental types

C++ standard does not ensure a one-to-one mapping:

- There are **five** distinct *fundamental types* (`char` , `short` , `int` , `long` , `long long`)
- There are **four** `int*_t` *overloads* (`int8_t` , `int16_t` , `int32_t` , and `int64_t`)

Warning: I/O Stream interprets `uint8_t` and `int8_t` as `char` and not as integer values

```
int8_t var;  
cin >> var; // read '2'  
cout << var; // print '2'  
int a = var * 2;  
cout << a; // print '100' !!
```

size_t <cstdint>

`size_t` is an *alias* data type capable of storing the biggest representable value on the current architecture

- `size_t` is an unsigned integer type (of at least 16-bit)
- `size_t` is the return type of `sizeof()` and commonly used to represent size measures
- `size_t` is 4 bytes on 32-bit architectures, and 8 bytes on 64-bit architectures
- C++23 adds `uz` / `UZ` literals for `size_t`, e.g. `5uz`

```
ptrdiff_t <cstdlib>
```

`ptrdiff_t` ↗ is an *aliases* data type used to store the results of the difference between pointers or iterators

- `ptrdiff_t` is the signed version of `size_t` commonly used for computing pointer differences
- `ptrdiff_t` are 4 bytes on 32-bit architectures, and 8 bytes on 64-bit architectures
- C++23 adds `z` / `Z` for `ptrdiff_t`, e.g. `5z`

```
uintptr_t <stdint>
```

`uintptr_t` ↗ (C++11) is an integer type that can be converted from and to a void pointer

- `uintptr_t` is an unsigned type
- `sizeof(uintptr_t) == sizeof(void*)`
- `uintptr_t` is an *optional* type of the standard and compilers may not provide it

Arithmetic Operation Semantics

Overflow The result of an arithmetic operation exceeds the word length, namely the largest positive/negative values

Wraparound The result of an arithmetic operation is reduced modulo 2^N where N is the number of bits of the word

Saturation The result of an arithmetic operation is constrained within a fixed range defined by a minimum and maximum value. If the result of an operation exceeds this range, it is “*clamped*” to the boundary value

Signed/Unsigned Integer Characteristics

Without undefined behavior, *signed* and *unsigned* integers use the same exact hardware, and they are equivalent at binary level thanks to the two-complement representation

```
#include <stdint>
int      a1 = INT_MAX;
int      b1 = a1 + 4; // 1000000000000000000000000000000011

unsigned a2 = INT_MAX;
unsigned b2 = a2 + 4; // 1000000000000000000000000000000011
```

However, *signed* and *unsigned* integers have different semantics in C++. The compiler can exploit undefined behavior to optimize the code even if such operations are well-defined at hardware level

Signed Integer

- ▣ Represent positive, negative, and zero values (\mathbb{Z})
- ▣ *Properties*: Commutative, reflexive, not associative (overflow/underflow)
- ✓ Represent the human intuition of numbers
- ✓ All bitwise operations are well-defined, except shift

Signed Integer - Problems

⚠ More negative values ($2^{31} - 1$) than positive ($2^{31} - 2$)

Even multiply, division, and modulo by -1 can fail, e.g. `INT_MIN * -1`

⚠ *Overflow/underflow semantic* → undefined behavior

Possible behavior: *overflow*: $(2^{31} - 1) + 1 \rightarrow \text{min}$, *underflow*: $-2^{31} - 1 \rightarrow \text{max}$

⚠ Shift could lead to undefined behavior `x << y`

- undefined behavior if `y` is larger than the number of bits of `x`
- implementation-defined if `x` is negative (until C++20)
- undefined behavior if `y` is negative

Unsigned Integer

- ❑ Represent only *non-negative* values (\mathbb{N})
- ❑ *Properties*: commutative, reflexive, associative
- ❑ Discontinuity in $0, 2^{32} - 1$
- ✅ Wraparound semantic \rightarrow well-defined (modulo 2^{32})
- ✅ Bit-wise operations are well-defined, except shift
- ⚠ Shift could lead to undefined behavior $x \ll y$
 - undefined behavior if y is larger than the number of bits of x

Google Style Guide

Because of historical accident, the C++ standard also uses unsigned integers to represent the size of containers - many members of the standards body believe this to be a mistake, but it is effectively impossible to fix at this point

Solution: use `int64_t`

max value: $2^{63} - 1 = 9,223,372,036,854,775,807$ or
9 quintillion (9 billion of billion),
about 292 years in nanoseconds,
9 million terabytes

When use signed integer?

- if it can be mixed with negative values, e.g. subtracting byte sizes
- prefer expressing non-negative values with signed integer and assertions
- optimization purposes, e.g. exploit undefined behavior for overflow or in loops

When use unsigned integer?

- if the quantity can never be mixed with negative values (?)
- bitmask values
- optimization purposes, e.g. division, modulo
- safety-critical system, signed integer overflow could be “non-deterministic”

Subscripts and sizes should be signed, *Bjarne Stroustrup*

Don't add to the signed/unsigned mess, *Bjarne Stroustrup*

Integer Type Selection in C++: in Safe, Secure and Correct Code, *Robert C. Seacord*

Arithmetic Type Limits

Query properties of arithmetic types in C++11:

```
#include <limits>

std::numeric_limits<int>::max();      //  $2^{31} - 1$ 
std::numeric_limits<uint16_t>::max(); // 65,535

std::numeric_limits<int>::min();      //  $-2^{31}$ 
std::numeric_limits<unsigned>::min(); // 0
```

* this syntax will be explained in the next lectures

Promotion and Truncation

Promotion to a larger type keeps the sign

```
int16_t x = -1;
int     y = x; // sign extend
cout << y;    // print -1
```

Truncation to a smaller type is implemented as a modulo operation with respect to the number of bits of the smaller type

```
int     x = 65537; // 2^16 + 1
int16_t y = x;    // x % 2^16
cout << y;       // print 1

int     z = 32769; // 2^15 + 1 (does not fit in a int16_t)
int16_t w = z;    // (int16_t) (x % 2^16 = 32769)
cout << w;       // print -32767
```

```
unsigned a = 10; // array is small
int      b = -1;
array[10ull + a * b] = 0; // ?
```

☠ Segmentation fault!

```
int f(int a, unsigned b, int* array) { // array is small
    if (a > b)
        return array[a - b]; // ?
    return 0;
}
```

☠ Segmentation fault for `a < 0`!

```
// v.size() return unsigned
for (size_t i = 0; i < v.size() - 1; i++)
    array[i] = 3; // ?
```

☠ Segmentation fault for `v.size() == 0`!

Easy case:

```
unsigned x = 32;    // x can be also a pointer
x         += 2u - 4; // 2u - 4 = 2 + (2^32 - 4)
           //           = 2^32 - 2
           // (32 + (2^32 - 2)) % 2^32
cout << x;         // print 30 (as expected)
```

What about the following code?

```
uint64_t x = 32;    // x can be also a pointer
x         += 2u - 4;
cout << x;
```

A real-world case:

```
// allocate a zero rtvec vector of N elements
//
// sizeof(struct rtvec_def) == 16
// sizeof(rtunion) == 8
rtvec rtvec_alloc(int n) {
    rtvec rt;
    int i;
    rt = (rtvec)obstack_alloc(
        rtl_obstack,
        sizeof(struct rtvec_def) + ((n - 1) * sizeof(rtunion)));
// ...
    return rt;
}
```

The C++ standard does not prescribe any specific behavior (undefined behavior) for several integer/unsigned arithmetic operations

- *Signed integer overflow/underflow*

```
int x = std::numeric_limits<int>::max() + 20;
```

- *More negative values than positive*

```
int x = std::numeric_limits<int>::max() * -1; // (231 - 1) * -1  
cout << x; // -231 + 1 ok
```

```
int y = std::numeric_limits<int>::min() * -1; // -231 * -1  
cout << y; // hard to see in complex examples // 231 overflow!!
```

- *Initialize* an integer with a value larger than its range is undefined behavior

```
int z = 3000000000; // undefined behavior!!
```

- *Bitwise operations* on signed integer types with negative value is undefined behavior

```
int y = -1 << 12;    // undefined behavior!!, until C++20
int z = 1 << -12;   // undefined behavior!!
```

- *Shift* larger than #bits of the data type is undefined behavior even for **unsigned**

```
unsigned y = 1u << 32u; // undefined behavior!!
```

- *Undefined behavior in implicit conversion*

```
uint16_t a = 65535; // 0xFFFF
uint16_t b = 65535; // 0xFFFF
cout << (a * b);    // print '-131071' undefined behavior!! (int overflow)
```

expected: 4'294'836'225

```
#include <limits>
#include <stdio>

void f(int* ptr, int pos) {
    pos++;
    if (pos < 0)    // <-- the compiler could assume that signed overflow never
        return;   //      happen and "simplify" the condition to check
    ptr[pos] = 0;
}

int main() {      // the code compiled with optimizations, e.g. -O3
    int* tmp = new int[10]; // leads to segmentation faults with clang, while
    f(tmp, INT_MAX);       // it terminates correctly with gcc
    printf("%d\n", tmp[0]);
}
```

s/open.c of the Linux kernel

```
int do_fallocate(..., loff_t offset, loff_t len) {
    inode *inode = ...;
    if (offset < 0 || len <= 0)
        return -EINVAL;
    /* Check for wrap through zero too */
    if ((offset + len > inode->i_sb->s_maxbytes) || (offset + len < 0))
        return -EFBIG;    // the compiler is able to infer that both 'offset' and
    ...                  // 'len' are non-negative and can eliminate this check,
}                        // without verify integer overflow
```

src/backend/utils/adt/int8.c of PostgreSQL

```
if (arg2 == 0) {
    ereport(ERROR, (errcode(ERRCODE_DIVISION_BY_ZERO), // the compiler is not aware
                  errmsg("division by zero")));        // that this function
}                                                       // doesn't return
/* No overflow is possible */
PG_RETURN_INT32((int32) arg1 / arg2); // the compiler assumes that the divisor is
                                       // non-zero and can move this statement on
                                       // the top (always executed)
```

Even worse example:

```
#include <iostream>

int main() {
    for (int i = 0; i < 4; ++i)
        std::cout << i * 1000000000 << std::endl;
}

// with optimizations, it is an infinite loop
// --> 1000000000 * i > INT_MAX
// undefined behavior!!

// the compiler translates the multiplication constant into an addition
```

Is the following loop safe?

```
void f(int size) {  
    for (int i = 1; i < size; i += 2)  
        ...  
}
```

- What happens if `size` is equal to `INT_MAX` ?
- How to make the previous loop safe?
- `i >= 0 && i < size` is not the solution because of *undefined behavior* of signed overflow
- Can we generalize the solution when the increment is `i += step` ?

Overflow / Underflow

Detecting wraparound for unsigned integral types is **not trivial**

```
// some examples
bool is_add_overflow(unsigned a, unsigned b) {
    return (a + b) < a || (a + b) < b;
}

bool is_mul_overflow(unsigned a, unsigned b) {
    unsigned x = a * b;
    return a != 0 && (x / a) != b;
}
```

Detecting overflow/underflow for signed integral types is even harder and must be checked before performing the operation

Saturation Arithmetic ★

C++26 adds four main functions to perform **saturation arithmetic** with integer types in the `<numeric>` library. In other words, the undefined behavior or the wrap-around behavior for overflow/underflow is replaced by **saturation** values, namely the *minimum* or *maximum* values of the operands

- `T add_sat(T x, T y)`
- `T sub_sat(T x, T y)`
- `T mul_sat(T x, T y)`
- `T div_sat(T x, T y)`
- `R saturate_cast<R>(T x)`

Floating-point Types and Arithmetic

IEEE Floating-Point Standard

IEEE754 is the technical standard for floating-point arithmetic

The standard defines the binary format, operations behavior, rounding rules, exception handling, etc.

First Release : 1985

Second Release : 2008. Add 16-bit, 128-bit, 256-bit floating-point types

Third Release : 2019. Specify min/max behavior

see The IEEE Standard 754: One for the History Books

IEEE754 technical document:

754-2019 - IEEE Standard for Floating-Point Arithmetic

In general, **C/C++ adopts IEEE754 floating-point standard:**

en.cppreference.com/w/cpp/types/numeric_limits/is_iec559

32/64-bit Floating-Point

- IEEE754 Single-precision (32-bit) float

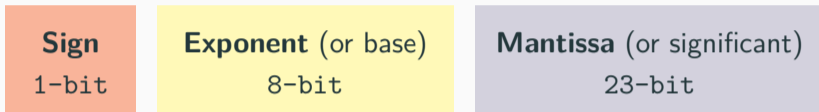

- IEEE754 Double-precision (64-bit) double

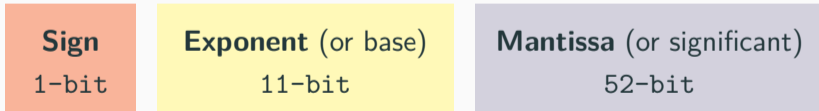

128/256-bit Floating-Point

- **IEEE754 Quad-Precision** (128-bit) `std::float128` C++23

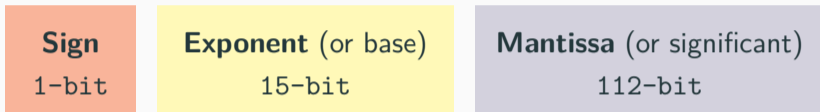

- **IEEE754 Octuple-Precision** (256-bit) (not standardized in C++)

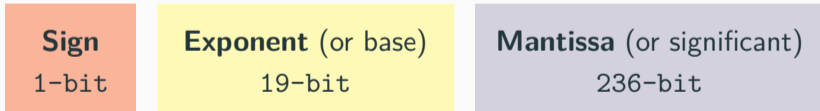

16-bit Floating-Point

- **IEEE754 16-bit Floating-point** (`std::binary16`) C++23 → GPU, Arm7

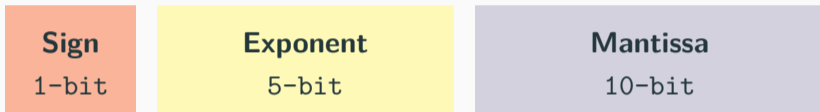

- **Google 16-bit Floating-point** (`std::bfloat16`) C++23 → TPU, GPU, Arm8

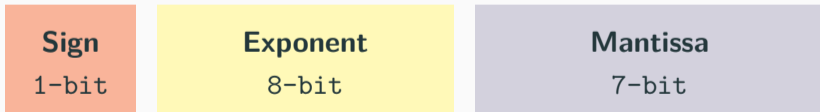

8-bit Floating-Point (Non-Standardized in C++/IEEE)

- E4M3

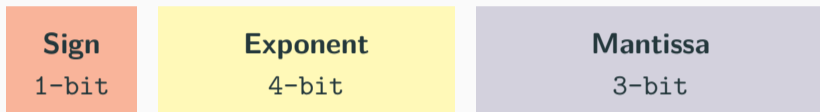

- E5M2

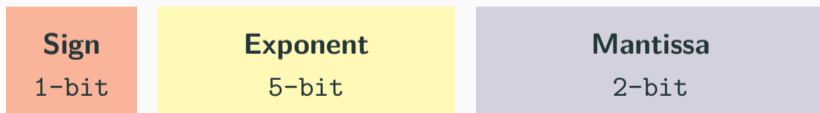

-
- Floating Point Formats for Machine Learning, *IEEE draft*
 - FP8 Formats for Deep Learning, *Intel, Nvidia, Arm*

- **TensorFloat-32 (TF32)** Specialized floating-point format for deep learning applications
- **Posit** (John Gustafson, 2017), also called *unum III (universal number)*, represents floating-point values with *variable-width* of exponent and mantissa. It is implemented in experimental platforms

-
- NVIDIA Hopper Architecture In-Depth
 - Beating Floating Point at its Own Game: Posit Arithmetic
 - Posits, a New Kind of Number, Improves the Math of AI
 - Comparing posit and IEEE-754 hardware cost

- **Microscaling Formats (MX)** Specification for low-precision floating-point formats defined by AMD, Arm, Intel, Meta, Microsoft, NVIDIA, and Qualcomm. It includes FP8, FP6, FP4, (MX)INT8
- **Fixed-point** representation has a fixed number of digits after the radix point (decimal point). The gaps between adjacent numbers are always equal. The range of their values is significantly limited compared to floating-point numbers. It is widely used on embedded systems

Floating-point number:

- *Radix* (or base): β
- *Precision* (or digits): p
- *Exponent* (magnitude): e
- *Mantissa*: M

$$n = \underbrace{M}_p \times \beta^e \quad \rightarrow \quad \text{IEEE754: } 1.M \times 2^e$$

```
float f1 = 1.3f;    // 1.3
float f2 = 1.1e2f; // 1.1 · 102
float f3 = 3.7E4f; // 3.7 · 104
float f4 = .3f;    // 0.3
double d1 = 1.3;   // without "f"
double d2 = 5E3;  // 5 · 103
```

Exponent Bias

In IEEE754 floating point numbers, the exponent value is offset from the actual value by the **exponent bias**

- The exponent is stored as an unsigned value suitable for comparison
- Floating point values are lexicographic ordered
- For a single-precision number, the exponent is stored in the range [1, 254] (0 and 255 have special meanings), and is biased by subtracting 127 to get an exponent value in the range [-126, +127]

| | | |
|---|-----------------------|--|
| 0 | 10000111 | 110000000000000000000000 |
| + | $2^{(135-127)} = 2^8$ | $\frac{1}{2^1} + \frac{1}{2^2} = 0.5 + 0.25 = 0.75 \xrightarrow{\text{normal}} 1.75$ |

$$+1.75 * 2^8 = 448.0$$

Normal number

A **normal** number is a floating point value that can be represented with *at least one bit set in the exponent* or the mantissa has all 0s

Denormal number

Denormal (or subnormal) numbers fill the underflow gap around zero in floating-point arithmetic. Any non-zero number with magnitude smaller than the smallest normal number is denormal

A **denormal** number is a floating point value that can be represented with *all 0s in the exponent*, but the mantissa is non-zero

Why denormal numbers make sense:

(↓ normal numbers)

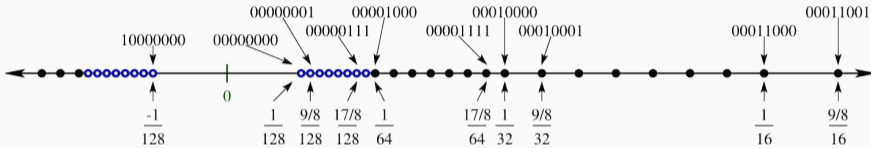

The problem: distance values from zero

(↓ denormal numbers)

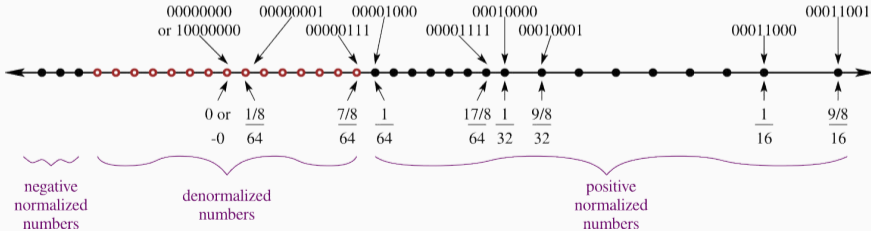

Infinity

In the IEEE754 standard, `inf` (infinity value) is a numeric data type value that exceeds the maximum (or minimum) representable value

Operations generating `inf`:

- $\pm\infty \cdot \pm\infty$
- $\pm\infty \cdot \pm\text{finite_value}$
- $\text{finite_value} \text{ op } \text{finite_value} > \text{max_value}$
- $\text{finite value} / \pm 0$

There is a single representation for `+inf` and `-inf`

Comparison: $(\text{inf} == \text{finite_value}) \rightarrow \text{false}$
 $(\pm\text{inf} == \pm\text{inf}) \rightarrow \text{true}$

```
cout << 5.0 / 0.0;    // print "inf"
cout << -5.0 / 0.0;   // print "-inf"

auto inf = std::numeric_limits<float>::infinity;
cout << (-0.0 == 0.0);           // true, 0 == 0
cout << ((5.0f / inf) == ((-5.0f / inf))); // true, 0 == 0
cout << (10e40f) == (10e40f + 9999999.0f); // true, inf == inf
cout << (10e40) == (10e40f + 9999999.0f); // false, 10e40 != inf
```

NaN

In the IEEE754 standard, NaN (not a number) is a numeric data type value representing an undefined or non-representable value

Floating-point operations generating NaN :

- Operations with a NaN as at least one operand
- $\pm\infty \cdot \mp\infty$, $0 \cdot \infty$
- $0/0$, ∞/∞
- \sqrt{x} , $\log(x)$ for $x < 0$
- $\sin^{-1}(x)$, $\cos^{-1}(x)$ for $x < -1$ or $x > 1$

Comparison: $(\text{NaN} == x)$ \rightarrow false, for every x

$(\text{NaN} == \text{NaN}) \rightarrow$ false

There are many representations for NaN (e.g. $2^{24} - 2$ for float)

The specific (bitwise) NaN value returned by an operation is implementation/compiler specific

```
cout << 0 / 0;           // undefined behavior
cout << 0.0 / 0.0;       // print "nan" or "-nan"
```

Machine epsilon

Machine epsilon ϵ (or *machine accuracy*) is defined to be the smallest number that can be added to 1.0 to give a number other than one

IEEE 754 Single precision : $\epsilon = 2^{-23} \approx 1.19209 * 10^{-7}$

IEEE 754 Double precision : $\epsilon = 2^{-52} \approx 2.22045 * 10^{-16}$

Units at the Last Place (ULP)

ULP

Units at the Last Place is the gap between consecutive floating-point numbers

$$ULP(p, e) = \beta^{e-(p-1)} \rightarrow 2^{e-(p-1)}$$

Example:

$$\beta = 10, p = 3$$

$$\pi = 3.1415926... \rightarrow x = 3.14 \times 10^0$$

$$ULP(3, 0) = 10^{-2} = 0.01$$

Relation with ϵ :

- $\epsilon = ULP(p, 0)$
- $ULP_x = \epsilon * \beta^{e(x)}$

Floating-Point Representation of a Real Number

The machine floating-point representation $\mathbf{fl}(x)$ of a *real number* x is expressed as $\mathbf{fl}(x) = x(1 + \delta)$, where δ is a small constant

The approximation of a *real number* x has the following properties:

Absolute Error: $|fl(x) - x| \leq \frac{1}{2} \cdot ULP_x$

Relative Error: $\left| \frac{fl(x) - x}{x} \right| \leq \frac{1}{2} \cdot \epsilon$

- NaN (mantissa $\neq 0$)



- \pm infinity



- Lowest/Largest ($\pm 3.40282 * 10^{+38}$)



- Minimum (normal) ($\pm 1.17549 * 10^{-38}$)



- Denormal number ($< 2^{-126}$)(minimum: $1.4 * 10^{-45}$)



- ± 0



| | E4M3 | E5M2 | half |
|------------------------------------|-------------------------|---------------------------------|------------------------------|
| Exponent | 4 [0*-14] (no inf) | 5-bit [0*-30] | |
| Bias | 7 | 15 | |
| Mantissa | 4-bit | 2-bit | 10-bit |
| Largest (\pm) | $1.75 * 2^8$ 448 | $1.75 * 2^{15}$ 57,344 | 2^{16} 65,536 |
| Smallest (\pm) | 2^{-6} 0.015625 | 2^{-14} 0.00006 | |
| Smallest Denormal | 2^{-9} 0.001953125 | 2^{-16} $1.5258 * 10^{-5}$ | 2^{-24} $6.0 * 10^{-8}$ |
| Epsilon | 2^{-4} 0.0625 | 2^{-2} 0.25 | 2^{-10} 0.00098 |

| | bfloat16 | float | double |
|------------------------------------|------------------------------------|------------------------------------|--------------------------------------|
| Exponent | 8-bit [0*-254] | | 11-bit [0*-2046] |
| Bias | 127 | | 1023 |
| Mantissa | 7-bit | 23-bit | 52-bit |
| Largest (\pm) | 2^{128} $3.4 \cdot 10^{38}$ | | 2^{1024} $1.8 \cdot 10^{308}$ |
| Smallest (\pm) | 2^{-126} $1.2 \cdot 10^{-38}$ | | 2^{-1022} $2.2 \cdot 10^{-308}$ |
| Smallest Denormal | / | 2^{-149} $1.4 \cdot 10^{-45}$ | 2^{-1074} $4.9 \cdot 10^{-324}$ |
| Epsilon | 2^{-7} 0.0078 | 2^{-23} $1.2 \cdot 10^{-7}$ | 2^{-52} $2.2 \cdot 10^{-16}$ |

Floating-point - Limits

```
#include <limits>
// T: float or double

std::numeric_limits<T>::max();           // largest value

std::numeric_limits<T>::lowest();       // lowest value (C++11)

std::numeric_limits<T>::min();          // smallest value

std::numeric_limits<T>::denorm_min()    // smallest (denormal) value

std::numeric_limits<T>::epsilon();      // epsilon value

std::numeric_limits<T>::infinity()     // infinity

std::numeric_limits<T>::quiet_NaN()    // NaN
```

Floating-point - Useful Functions

```
#include <cmath> // C++11

bool std::isnan(T value)      // check if value is NaN
bool std::isinf(T value)     // check if value is ±infinity
bool std::isfinite(T value)  // check if value is not NaN
                               // and not ±infinity

bool std::isnormal(T value); // check if value is Normal

T    std::ldexp(T x, p)       // exponent shift  $x * 2^p$ 
int  std::ilogb(T value)     // extracts the exponent of value
```

Floating-point operations are written

- \oplus addition
- \ominus subtraction
- \otimes multiplication
- \oslash division

$$\odot \in \{\oplus, \ominus, \otimes, \oslash\}$$

$op \in \{+, -, *, /\}$ denotes exact precision operations

(P1) In general, $a \text{ op } b \neq a \odot b$

(P2) **Not Reflexive** $a \neq a$

- *Reflexive* without NaN

(P3) **Not Commutative** $a \odot b \neq b \odot a$

- *Commutative* without NaN (NaN \neq NaN)

(P4) In general, **Not Associative** $(a \odot b) \odot c \neq a \odot (b \odot c)$

- even excluding NaN and `inf` in intermediate computations

(P5) In general, **Not Distributive** $(a \oplus b) \otimes c \neq (a \otimes c) \oplus (b \otimes c)$

- even excluding NaN and `inf` in intermediate computations

(P6) **Identity on operations is not ensured**

- $(a \ominus b) \oplus b \neq a$
- $(a \oslash b) \otimes b \neq a$

(P7) **Overflow/Underflow** Floating-point has “saturation” values inf , $-\text{inf}$

- as opposite to integer arithmetic with wrap-around behavior

Special Values Behavior

Zero behavior

- $a \otimes 0 = \text{inf}$, $a \in \{\text{finite} - 0\}$ [IEEE-764], undefined behavior in C++
- $0 \otimes 0$, $\text{inf} \otimes 0 = \text{NaN}$ [IEEE-764], undefined behavior in C++
- $0 \otimes \text{inf} = \text{NaN}$
- $+0 = -0$ but they have a different binary representation

Inf behavior

- $\text{inf} \odot a = \text{inf}$, $a \in \{\text{finite} - 0\}$
- $\text{inf} \oplus \otimes \text{inf} = \text{inf}$
- $\text{inf} \ominus \otimes \text{inf} = \text{NaN}$
- $\pm \text{inf} \odot \mp \text{inf} = \text{NaN}$
- $\pm \text{inf} = \pm \text{inf}$

NaN behavior

- $\text{NaN} \odot a = \text{NaN}$
- $\text{NaN} \neq a$

Floating-Point Undefined Behavior

- **Division by zero**

e.g., `108/0.0`

- **Conversion to a narrower floating-point type:**

e.g., `0.1 double → float`

- **Conversion from floating-point to integer:**

e.g., `108 float → int`

- **Operations on signaling NaNs:** Arithmetic operations that cause an “invalid operation” exception to be signaled

e.g., `inf - inf`

- **Incorrectly assuming IEEE-754 compliance for all platforms:**

e.g., Some embedded Linux distribution on ARM

C++11 allows determining if a floating-point exceptional condition has occurred by using floating-point exception facilities provided in `<cfenv>`

```
#include <cfenv>
// MACRO
FE_DIVBYZERO // division by zero
FE_INEXACT   // rounding error
FE_INVALID   // invalid operation, i.e. NaN
FE_OVERFLOW  // overflow (reach saturation value +inf)
FE_UNDERFLOW // underflow (reach saturation value -inf)
FE_ALL_EXCEPT // all exceptions

// functions
std::feclearexcept(FE_ALL_EXCEPT); // clear exception status
std::fetestexcept(<macro>);         // returns a value != 0 if an
                                     // exception has been detected
```



```
#include <cfenv>    // floating point exceptions
#include <iostream>
#pragma STDC FENV_ACCESS ON // tell the compiler to manipulate the floating-point
                             // environment (not supported by all compilers)
                             // gcc: yes, clang: no

int main() {
    std::feclearexcept(FE_ALL_EXCEPT); // clear
    auto x = 1.0 / 0.0;                  // all compilers
    std::cout << (bool) std::fetestexcept(FE_DIVBYZERO); // print true

    std::feclearexcept(FE_ALL_EXCEPT); // clear
    auto x2 = 0.0 / 0.0;                  // all compilers
    std::cout << (bool) std::fetestexcept(FE_INVALID); // print true

    std::feclearexcept(FE_ALL_EXCEPT); // clear
    auto x4 = 1e38f * 10;                 // gcc: ok
    std::cout << std::fetestexcept(FE_OVERFLOW);      // print true
}
```

Floating-point Issues



Ariane 5: data conversion from 64-bit floating point value to 16-bit signed integer → *\$137 million*



Patriot Missile: small chopping error at each operation, 100 hours activity → *28 deaths*

Integer type is more accurate than floating type for large numbers

```
cout << 16777217;           // print 16777217
cout << (int) 16777217.0f; // print 16777216!!
cout << (int) 16777217.0; // print 16777217, double ok
```

float numbers are different from double numbers

```
cout << (1.1 != 1.1f); // print true !!!
```

The floating point precision is finite!

```
cout << setprecision(20);  
cout << 3.33333333f; // print 3.333333254!!  
cout << 3.33333333; // print 3.333333333  
cout << (0.1 + 0.1 + 0.1 + 0.1 + 0.1 + 0.1); // print 0.59999999999999998
```

Floating point arithmetic is not associative

```
cout << 0.1 + (0.2 + 0.3) == (0.1 + 0.2) + 0.3; // print false
```

IEEE754 Floating-point computation guarantees to produce **deterministic** output, namely the exact bitwise value for each run, if and only if the **order of the operations is always the same**

→ *same result on any machine and for all runs*

“Using a double-precision floating-point value, we can represent easily the number of atoms in the universe.

If your software ever produces a number so large that it will not fit in a double-precision floating-point value, chances are good that you have a bug”

Daniel Lemire, Prof. at the University of Quebec

“ NASA uses just 15 digits of π to calculate interplanetary travel. With 40 digits, you could calculate the circumference of a circle the size of the visible universe with an accuracy that would fall by less than the diameter of a single hydrogen atom”

Latest in space, Twitter

Floating-point Algorithms

- **addition algorithm** (simplified):

- (1) Compare the exponents of the two numbers. Shift the smaller number to the right until its exponent would match the larger exponent
- (2) Add the mantissa
- (3) Normalize the sum if needed (shift right/left the exponent by 1)

- **multiplication algorithm** (simplified):

- (1) Multiplication of mantissas. The number of bits of the result is twice the size of the operands (46 + 2 bits, with +2 for implicit normalization)
- (2) Normalize the product if needed (shift right/left the exponent by 1)
- (3) Addition of the exponents

- **fused multiply-add (fma):**

- Recent architectures (also GPUs) provide *fma* to compute addition and multiplication in a single instruction (performed by the compiler in most cases)
- The rounding error of $fma(x, y, z)$ is less than $(x \otimes y) \oplus z$

Catastrophic Cancellation

Catastrophic cancellation (or *loss of significance*) refers to loss of relevant information in a floating-point computation that cannot be reversed

Two cases:

- (C1) $\mathbf{a} \pm \mathbf{b}$, where $\mathbf{a} \gg \mathbf{b}$ or $\mathbf{b} \gg \mathbf{a}$. The value (or part of the value) of the smaller number is lost
- (C2) $\mathbf{a} - \mathbf{b}$, where \mathbf{a}, \mathbf{b} are approximation of exact values and $\mathbf{a} \approx \mathbf{b}$, namely a loss of precision in both \mathbf{a} and \mathbf{b} . $\mathbf{a} - \mathbf{b}$ cancels most of the relevant part of the result because $\mathbf{a} \approx \mathbf{b}$. It implies a *small absolute error* but a *large relative error*

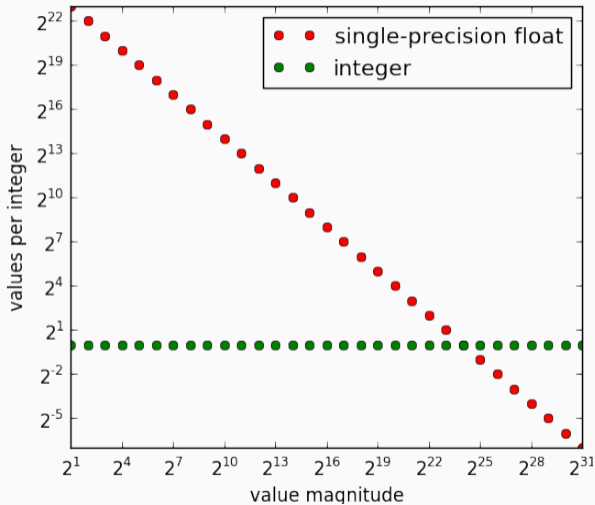

Intersection = 16,777,216 = 2^{24}

How many iterations performs the following code?

```
while (x > 0)
    x = x - y;
```

How many iterations?

```
float:  x = 10,000,000  y = 1      -> 10,000,000
float:  x = 30,000,000  y = 1      -> does not terminate
float:  x =   200,000   y = 0.001  -> does not terminate
bfloat: x =           256  y = 1    -> does not terminate !!
```

Floating-point increment

```
float x = 0.0f;
for (int i = 0; i < 20000000; i++)
    x += 1.0f;
```

What is the value of `x` at the end of the loop?

Ceiling division $\left\lceil \frac{a}{b} \right\rceil$

```
//          std::ceil((float) 101 / 2.0f) -> 50.5f -> 51
float x = std::ceil((float) 20000001 / 2.0f);
```

What is the value of `x`?

Let's solve a quadratic equation:

$$x_{1,2} = \frac{-b \pm \sqrt{b^2 - 4ac}}{2a}$$

$$x^2 + 5000x + 0.25$$

```
(-5000 + std::sqrt(5000.0f * 5000.0f - 4.0f * 1.0f * 0.25f)) / 2 // x2
(-5000 + std::sqrt(25000000.0f - 1.0f)) / 2 // catastrophic cancellation (C1)
(-5000 + std::sqrt(25000000.0f)) / 2
(-5000 + 5000) / 2 = 0 // catastrophic cancellation (C2)
// correct result: 0.00005!!
```

$$\text{relative error: } \frac{|0 - 0.00005|}{0.00005} = 100\%$$

The problem

```
cout << (0.11f + 0.11f < 0.22f); // print true!!  
cout << (0.1f + 0.1f > 0.2f);    // print true!!
```

Do not use absolute error margins!!

```
bool areFloatNearlyEqual(float a, float b) {  
    if (std::abs(a - b) < epsilon); // epsilon is fixed by the user  
        return true;  
    return false;  
}
```

Problems:

- Fixed epsilon “looks small” but it could be too large when the numbers being compared are very small
- If the compared numbers are very large, the epsilon could end up being smaller than the smallest rounding error, so that the comparison always returns false

Solution: Use relative error $\frac{|a-b|}{b} < \epsilon$

```
bool areFloatNearlyEqual(float a, float b) {  
    if (std::abs(a - b) / b < epsilon); // epsilon is fixed  
        return true;  
    return false;  
}
```

Problems:

- $a=0$, $b=0$ The division is evaluated as $0.0/0.0$ and the whole if statement is $(\text{nan} < \text{epsilon})$ which always returns false
- $b=0$ The division is evaluated as $\text{abs}(a)/0.0$ and the whole if statement is $(+\text{inf} < \text{epsilon})$ which always returns false
- a and b very small. The result should be true but the division by b may produce wrong results
- It is not commutative. We always divide by b

Possible solution: $\frac{|a-b|}{\max(|a|,|b|)} < \varepsilon$

```
bool areFloatNearlyEqual(float a, float b) {
    constexpr float normal_min      = std::numeric_limits<float>::min();
    constexpr float relative_error = <user_defined>

    if (!std::isfinite(a) || !isfinite(b)) // a = ±∞, NaN or b = ±∞, NaN
        return false;
    float diff = std::abs(a - b);
    // if "a" and "b" are near to zero, the relative error is less effective
    if (diff <= normal_min) // or also: user_epsilon * normal_min
        return true;

    float abs_a = std::abs(a);
    float abs_b = std::abs(b);
    return (diff / std::max(abs_a, abs_b)) <= relative_error;
}
```

Minimize Error Propagation - Summary

- Prefer **multiplication/division** rather than addition/subtraction
- Try to reorganize the computation to **keep near** numbers with the same scale (e.g. sorting numbers)
- Consider **putting a zero** very small number (under a threshold). Common application: iterative algorithms
- Scale by a **power of two** is safe
- **Switch to log scale**. Multiplication becomes Add, and Division becomes Subtraction
- Use a **compensation algorithm** like Kahan summation, Dekker's FastTwoSum, Rump's AccSum

Suggest readings:

- [What Every Computer Scientist Should Know About Floating-Point Arithmetic](#)
- [Do Developers Understand IEEE Floating Point?](#)
- [Yet another floating point tutorial](#)
- [Unavoidable Errors in Computing](#)

Floating-point Comparison readings:

- [The Floating-Point Guide - Comparison](#)
- [Comparing Floating Point Numbers, 2012 Edition](#)
- [Some comments on approximately equal FP comparisons](#)
- [Comparing Floating-Point Numbers Is Tricky](#)

Floating point tools:

- [IEEE754 visualization/converter](#)
- [Find and fix floating-point problems](#)

System/360 Model 44

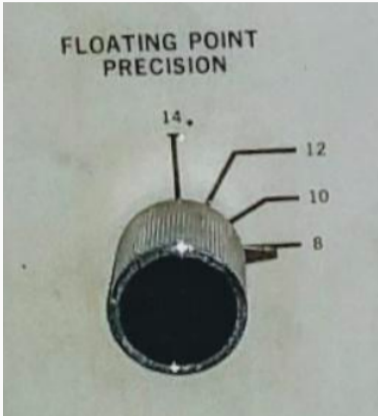

Ken Shirriff: Want to adjust your computer's floating point precision by turning a knob? You could do that on the System/360 Model 44

On Floating-Point



DURING A COMPETITION, I TOLD THE PROGRAMMERS ON OUR TEAM THAT $e^\pi - \pi$ WAS A STANDARD TEST OF FLOATING-POINT HANDLERS -- IT WOULD COME OUT TO 20 UNLESS THEY HAD ROUNDING ERRORS.

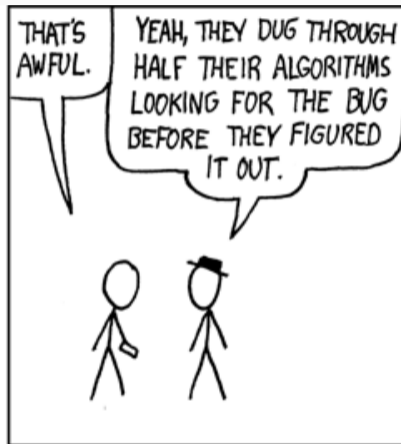

Modern C++ Programming

4. BASIC CONCEPTS III

ENTITIES AND CONTROL FLOW

Federico Busato

2024-11-05

1 Entities

2 Declaration and Definition

3 Enumerators

4 struct, Bitfield, and union

- struct
- Anonymous and Unnamed struct★
- Bitfield
- union

5 Control Flow

- `if` Statement
- `for` and `while` Loops
- Range-based `for` Loop
- `switch`
- `goto`
- Avoid Unused Variable Warning

6 Namespace

- Explicit Global Namespace
- Namespace Alias
- `using`-Declaration
- `using namespace`-Directive
- `inline` Namespace ★

7 Attributes ★

- `[[nodiscard]]`
- `[[maybe_unused]]`
- `[[deprecated]]`
- `[[noreturn]]`

Entities

Entities

A C++ program is set of language-specific *keywords* (`for`, `if`, `new`, `true`, etc.), *identifiers* (symbols for variables, functions, structures, namespaces, etc.), *expressions* defined as sequence of operators, and *literals* (constant value tokens)

C++ Entity

An **entity** is a value, object, reference, function, enumerator, type, class member, or template

Identifiers and *user-defined operators* are the names used to refer to *entities*

Entities also captures the result(s) of an *expression*

Preprocessor macros are not C++ entities

Declaration and Definition

Declaration/Definition

Declaration/Prototype

A **declaration** (or *prototype*) introduces an *entity* with an *identifier* describing its type and properties

A *declaration* is what the compiler and the linker needs to accept references (usage) to that identifier

Entities can be declared multiple times. All declarations are the same

Definition/Implementation

An entity **definition** is the implementation of a declaration. It defines the properties and the behavior of the entity

For each entity, only a single *definition* is allowed

Declaration/Definition Function Example

```
void f(int a, char* b); // function declaration

void f(int a, char*) { // function definition
    ...                // "b" can be omitted if not used
}

void f(int a, char* b); // function declaration
                        // multiple declarations is valid

f(3, "abc");           // usage
```

```
void g(); // function declaration

g();      // linking error "g" is not defined
```

Declaration/Definition struct Example

A declaration without a concrete implementation is an incomplete type (as `void`)

```
struct A; // declaration 1
struct A; // declaration 2 (ok)

struct B { // declaration and definition
    int b;
// A x; // compile error incomplete type
    A* y; // ok, pointer to incomplete type
};

struct A { // definition
    char c;
}
```

Enumerators

Enumerator

An **enumerator** `enum` is a data type that groups a set of named integral constants

```
enum color_t { BLACK, BLUE, GREEN };

color_t color = BLUE;
cout << (color == BLACK); // print false
```

The problem:

```
enum color_t { BLACK, BLUE, GREEN };
enum fruit_t { APPLE, CHERRY };

color_t color = BLACK;    // int: 0
fruit_t fruit = APPLE;    // int: 0
bool    b      = (color == fruit); // print 'true'!!
// and, most importantly, does the match between a color and
// a fruit make any sense?
```

Strongly Typed Enumerator - enum class

enum class (C++11)

enum class (scoped enum) data type is a *type safe* enumerator that is not implicitly convertible to int

```
enum class Color { BLACK, BLUE, GREEN };
```

```
enum class Fruit { APPLE, CHERRY };
```

```
Color color = Color::BLUE;
```

```
Fruit fruit = Fruit::APPLE;
```

```
// bool b = (color == fruit) compile error we are trying to match colors with fruits
```

```
// BUT, they are different things entirely
```

```
// int a1 = Color::GREEN; compile error
```

```
// int a2 = Color::RED + Color::GREEN; compile error
```

```
int a3 = (int) Color::GREEN; // ok, explicit conversion
```

enum/enum class Features

- enum/enum class can be compared

```
enum class Color { RED, GREEN, BLUE };  
cout << (Color::RED < Color::GREEN); // print true
```

- enum/enum class are automatically enumerated in increasing order

```
enum class Color { RED, GREEN = -1, BLUE, BLACK };  
//           (0)  (-1)           (0)  (1)  
Color::RED == Color::BLUE; // true
```

- enum/enum class can contain alias

```
enum class Device { PC = 0, COMPUTER = 0, PRINTER };
```

- C++11 enum/enum class allows setting the underlying type

```
enum class Color : int8_t { RED, GREEN, BLUE };
```

- C++17 `enum class` supports *direct-list-initialization*

```
enum class Color { RED, GREEN, BLUE };  
Color a{2}; // ok, equal to Color:BLUE
```

- C++17 `enum/enum class` support *attributes*

```
enum class Color { RED, GREEN, BLUE [[deprecated]] };  
auto x = Color::BLUE; // compiler warning
```

enum class Features - C++20

- C++20 allows introducing the enumerator identifiers into the local scope to decrease the verbosity

```
enum class Color { RED, GREEN, BLUE };

switch (x) {
    using enum Color; // C++20
    case RED:
    case GREEN:
    case BLUE:
}
```

The same behavior can be emulated in older C++ versions with

```
enum class Color { RED, GREEN, BLUE };

constexpr auto RED = Color::RED;
```

enum/enum class - Common Errors

- `enum/enum class` should be always initialized

```
enum class Color { RED, GREEN, BLUE };
```

```
Color my_color; // "my_color" may be outside RED, GREEN, BLUE!!
```

- **C++17** Cast from *out-of-range values* respect to the *underlying type* of `enum/enum class` leads to undefined behavior

```
enum Color : uint8_t { RED, GREEN, BLUE };
```

```
Color value = 256; // undefined behavior
```

- C++17 `constexpr` expressions don't allow *out-of-range values* for (only) `enum` without explicit *underlying type*

```
enum      Color      { RED };
enum      Fruit : int { APPLE };
enum class Device    { PC };

// constexpr Color a1 = (Color) -1; compile error
const     Color a2 = (Color) -1; // ok
constexpr Fruit a3 = (Fruit) -1; // ok
constexpr Device a4 = (Device) -1; // ok
```

struct, **Bitfield**, and union

A `struct` (*structure*) aggregates different variables into a single unit

```
struct A {  
    int x;  
    char y;  
};
```

It is possible to declare one or more variables after the definition of a `struct`

```
struct A {  
    int x;  
} a, b;
```

Enumerators can be declared within a `struct` without a name

```
struct A {  
    enum {X, Y}  
};  
A::X;
```

It is possible to declare a `struct` in a local scope (with some restrictions), e.g. function scope

```
int f() {  
    struct A {  
        int x;  
    } a;  
    return a.x;  
}
```

Anonymous and Unnamed struct★

Unnamed struct: a structured without a name, but with an associated type

Anonymous struct: a structured without a name and type

The C++ standard allows *unnamed struct* but, contrary to C, does not allow *anonymous struct* (i.e. without a name)

```
struct {  
    int x;  
} my_struct;           // unnamed struct, ok  
  
struct S {  
    int x;  
    struct { int y; }; // anonymous struct, compiler warning with -Wpedantic  
};                     // -Wpedantic: diagnose use of non-strict ISO C++ extensions
```

Bitfield

A **bitfield** is a variable of a structure with a predefined bit width. A bitfield can hold bits instead bytes

```
struct S1 {
    int b1 : 10; // range [0, 1023]
    int b2 : 10; // range [0, 1023]
    int b3 : 8;  // range [0, 255]
}; // sizeof(S1): 4 bytes

struct S2 {
    int b1 : 10;
    int    : 0; // reset: force the next field
             // to start at bit 32
    int b2 : 10;
}; // sizeof(S2): 8 bytes
```

Union

A `union` is a special data type that allows to store different data types in the same memory location

- The `union` is only as big as necessary to hold its *largest* data member
- The `union` is a kind of “*overlapping*” storage

```
union A {  
    int x;  
    char y;  
};
```

```
A a;  
a.x = 0xAABBCCDD
```

x 0xDD 0xCC 0xBB 0xAA

y 0xDD

Note: little endian

```
union A {
    int x;
    char y;
}; // sizeof(A): 4

A a;
a.x = 1023; // bits: 00..0000011111111111
a.y = 0; // bits: 00..0000011000000000
cout << a.x; // print 512 + 256 = 768
```

NOTE: Little-Endian encoding maps the bytes of a value in memory in the reverse order. `y` maps to the last byte of `x`

Contrary to `struct`, C++ allows *anonymous union* (i.e. without a name)

C++17 introduces `std::variant` to represent a *type-safe union*

Control Flow

if Statement

The `if` statement executes the first branch if the specified condition is evaluated to `true`, the second branch otherwise

- *Short-circuiting:*

```
if (<true expression> r | array[-1] == 0)
... // no error!! even though index is -1
    // left-to-right evaluation
```

- *Ternary operator:*

```
<cond> ? <expression1> : <expression2>
```

`<expression1>` and `<expression2>` must return a value of the same or convertible type

```
int value = (a == b) ? a : (b == c ? b : 3); // nested
```

for and while Loops

- **for**

```
for ([init]; [cond]; [increment]) {  
    ...  
}
```

To use when number of iterations is known

- **while**

```
while (cond) {  
    ...  
}
```

To use when number of iterations is not known

- **do while**

```
do {  
    ...  
} while (cond);
```

To use when number of iterations is not known, but there is at least one iteration

for Loop Features and Jump Statements

- C++ allows multiple initializations and increments in the declaration:

```
for (int i = 0, k = 0; i < 10; i++, k += 2)
    ...
```

- Infinite loop:

```
for (;;) // also while(true);
    ...
```

- Jump statements (**break**, **continue**, **return**):

```
for (int i = 0; i < 10; i++) {
    if (<condition>)
        break; // exit from the loop
    if (<condition>)
        continue; // continue with a new iteration and exec. i++
    return; // exit from the function
}
```

C++11 introduces the **range-based for loop** to simplify the verbosity of traditional for loop constructs. They are equivalent to the for loop operating over a range of values, but **safer**

The range-based for loop avoids the user to specify start, end, and increment of the loop

```
for (int v : { 3, 2, 1 }) // INITIALIZER LIST
    cout << v << " ";    // print: 3 2 1

int values[] = { 3, 2, 1 };
for (int v : values)     // ARRAY OF VALUES
    cout << v << " ";   // print: 3 2 1

for (auto c : "abcd")    // RAW STRING
    cout << c << " ";   // print: a b c d
```

Range-based for loop can be applied in three cases:

- Fixed-size array `int array[3]` , `"abcd"`
- Branch Initializer List `{1, 2, 3}`
- Any object with `begin()` and `end()` methods

```
std::vector vec{1, 2, 3, 4};

for (auto x : vec) {
    cout << x << ", ";
}
// print:  "1, 2, 3, 4"
```

```
int matrix[2][4];
for (auto& row : matrix) {
    for (auto element : row)
        cout << "@";
    cout << "\n";
}
// print:  @@@@
//         @@@@
```

C++17 extends the concept of **range-based loop** for *structure binding*

```
struct A {  
    int x;  
    int y;  
};  
  
A array[] = { {1,2}, {5,6}, {7,1} };  
for (auto [x1, y1] : array)  
    cout << x1 << "," << y1 << " "; // print: 1,2 5,6 7,1
```

The `switch` statement evaluates an expression (`int`, `char`, `enum class`, `enum`) and executes the statement associated with the matching case value

```
char x = ...
switch (x) {
    case 'a': y = 1; break;
    default: return -1;
}
return y;
```

Switch scope:

```
int x = 1;
switch (1) {
    case 0: int x;      // nearest scope
    case 1: cout << x; // undefined!!
    case 2: { int y; } // ok
// case 3: cout << y; // compile error
}
```

Fall-through:

```
MyEnum x
int y = 0;
switch (x) {
    case MyEnum::A:      // fall-through
    case MyEnum::B:      // fall-through
    case MyEnum::C: return 0;
    default: return -1;
}
```

C++17 `[[fallthrough]]` attribute

```
char x = ...
switch (x) {
    case 'a': x++;
                [[fallthrough]]; // C++17: avoid warning
    case 'b': return 0;
    default: return -1;
}
```

Control Flow with Initializing Statement

Control flow with **initializing statement** aims at simplifying complex actions before the condition evaluation and restrict the scope of a variable which is visible only in the control flow body

C++17 introduces `if` statement with initializer

```
if (int ret = x + y; ret < 10)
    cout << ret;
```

C++17 introduces `switch` statement with initializer

```
switch (auto i = f(); x) {
    case 1: return i + x;
```

C++20 introduces `range-for` loop statement with initializer

```
for (int i = 0; auto x : {'A', 'B', 'C'})
    cout << i++ << ":" << x << " "; // print: 0:A 1:B 2:C
```

When `goto` could be useful:

```
bool flag = true;
for (int i = 0; i < N && flag; i++) {
    for (int j = 0; j < M && flag; j++) {
        if (<condition>)
            flag = false;
    }
}
```

become:

```
for (int i = 0; i < N; i++) {
    for (int j = 0; j < M; j++) {
        if (<condition>)
            goto LABEL;
    }
}
LABEL: ;
```



Best solution:

```
bool my_function(int M, int M) {
    for (int i = 0; i < N; i++) {
        for (int j = 0; j < M; j++) {
            if (<condition>)
                return false;
        }
    }
    return true;
}
```

Junior: what's wrong
with goto command?

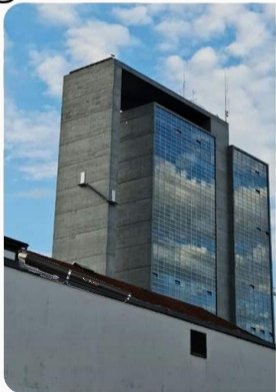
goto command:

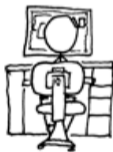
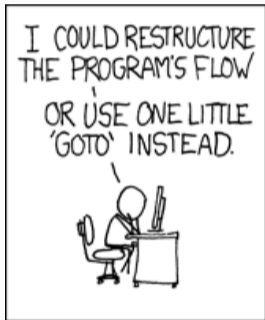



Most compilers issue a warning when a variable is unused. There are different situations where a variable is expected to be unused

```
// EXAMPLE 1: macro dependency  
int f(int value) {  
    int x = value;  
    #if defined(ENABLE_SQUARE_PATH)  
        return x * x;  
    #else  
        return 0;  
    #endif  
}
```

```
// EXAMPLE 2: constexpr dependency (MSVC)  
template<typename T>  
int f(T value) {  
    if constexpr (sizeof(value) >= 4)  
        return 1;  
    else  
        return 2;  
}
```

```
// EXAMPLE 3: decltype dependency (MSVC)  
template<typename T>  
int g(T value) {  
    using R = decltype(value);  
    return R{};  
}
```

There are different ways to solve the problem depending on the standard used

- Before C++17: `static_cast<void>(var)`
- C++17 `[[maybe_unused]]` attribute
- C++26 `auto _`

```
[[maybe_unused]] int x = value;
int y = 3;
static_cast<void>(y);
auto _ = 3;
auto _ = 4; // _ repetition is not an error

void f([[maybe_unused]] int x) {}
```

Namespace

The problem: Named entities, such as variables, functions, and compound types declared outside any block has *global scope*, meaning that its name/symbol is valid anywhere in the code

Namespaces ↗ allow grouping named entities that otherwise would have global scope into narrower scopes, giving them **namespace scope**

Namespaces provide a method for preventing name conflicts in large projects. Symbols declared inside a *namespace block* are placed in a *named scope* that prevents them from being mistaken for symbols with identical names

Namespace Syntax

```
namespace [<name>] {  
  
    <identifier> // variable, function, struct, type, etc.  
  
} // namespace <name>  
  
<name>::<identifier> // use the identifier
```

The operator `::` is called **scope resolution operator** and it allows accessing identifiers that are defined in other namespaces

Namespace Example 1

```
#include <iostream>
namespace my_namespace1 {
void f() {
    std::cout << "my_namespace1" << std::endl;
}
} // namespace my_namespace1

namespace my_namespace2 {
void f() {
    std::cout << "my_namespace2" << std::endl;
}
} // namespace my_namespace2

int main () {
    my_namespace1::f(); // print "my_namespace1"
    my_namespace2::f(); // print "my_namespace2"
    // f(); // compile error f() is not visible
}
```

Namespace - Alternative Syntax

It is also possible to declare entities in a preexisting namespace by adding the name as a prefix:

```
namespace <name> {}  
<name>::<identifier>
```

```
#include <iostream>  
namespace my_namespace1 {}  
  
void my_namespace2::f() { std::cout << "my_namespace2" << std::endl; }  
  
int main () {  
    my_namespace1::f(); // print "my_namespace1"  
}
```

Special Namespaces

- All functionalities and data types provided with the **standard library** (distributed along with the compiler) are declared within the `std` namespace
- The global namespace can be specified with `::identifier` and can be useful to prevent conflicts with surrounding namespaces
- It is also possible to define a namespace without a name. The concept refers to *anonymous (or unnamed) namespace*
See "Translation Unit I" lecture for more details

Nested Namespaces

```
namespace my_namespace1 {  
void f() { cout << "my_namespace1::f()"; }  
  
namespace my_namespace2 {  
  
void f() { cout << "my_namespace1::my_namespace2::f()"; }  
  
} // namespace my_namespace2  
} // namespace my_namespace1  
  
my_namespace1::my_namespace2::f();
```

C++17 allows *nested namespace* definitions with a less verbose syntax:

```
namespace my_namespace1::my_namespace2 {  
    void h();  
}
```

Explicit Global Namespace

The explicit global namespace syntax `::identifier` can be useful to prevent conflicts with surrounding namespaces

```
void f() { cout << "global::f()"; }

namespace my_namespace {

void f() { cout << "my_namespace::f()"; }

void g() {
    f(); // print "my_namespace::f()"
    ::f(); // print "global::f()"
}

} // namespace my_namespace
```

Namespace Alias

Namespace alias allows declaring an alternate name for an existing namespace

```
namespace very_long_namespace {  
    namespace even_longer {  
        void g() {}  
    } // namespace even_longer  
} // namespace very_long_namespace  
  
namespace ns1 = very_long_namespace::even_longer;    // namespace alias  
  
int main() {  
    namespace ns2 = very_long_namespace::even_longer; // namespace alias  
                                                    // available only in this scope  
  
    ns1::g();  
    ns2::g();  
}
```

The `using-declaration` introduces a specific name/system from a namespace into the current scope. This is useful for improving code readability and reducing verbosity

The `using-declaration` is roughly equivalent of declaring the name/system in the current scope

Syntax:

```
namespace <name> {  
    <identifier>  
}  
  
using <name>::<identifier>;  
<identifier>;
```



```
namespace my_namespace {  
  
void f() { cout << "my_namespace::f()"; }  
  
struct S {};  
  
using T = int;  
  
} // namespace my_namespace  
  
using my_namespace::f;  
using my_namespace::S;  
using my_namespace::T;  
f(); // print "my_namespace::f()"  
S s;  
T x;  
  
// struct S {}; // compile error "struct S" already defined by my_namespace::T
```

using namespace-Directive

The `using namespace`-directive introduces all the identifiers in a *scope* without having to specify them explicitly with the namespace name

Similarly to `using`-declaration, it is useful for improving code readability and reducing verbosity. On the other hand, it could make the code bug-prone because of the complex name lookup rules, especially if coupled with function overloading

It is generally recommended not to write `using namespace`, especially at the global level. Otherwise, it defeats the purpose of the namespace

using namespace-Directive

```
namespace my_namespace {  
  
void f() { cout << "my_namespace::f()"; }  
  
struct S {};  
  
} // namespace my_namespace  
  
int main () {  
    using namespace my_namespace;  
    f();      // print "my_namespace::f()"  
    S s;  
}
```

using namespace-Directive vs. using-declaration

```
namespace A { int x = 0; }

namespace B {
    int y = 3;
    int x = 7;
}

int main () {
    using namespace A;
    int x = 3;    // ok!! even if it is already defined in my_namespace
    using B::y;
    // int y = 5;    // compiler error!! "y" is already defined in this scope
}

void f() {
    using B::x;
    using namespace A;
    cout << x;    // print 7, B::x has higher priority
}
```

`using namespace`-directive has the transitive property for its identifiers when used into another namespace

```
namespace A {  
    void f() { cout << "A::f()"; }  
}  
  
namespace B {  
    using namespace A;  
}  
  
int main() {  
    using namespace B;  
    f(); // ok, print "A::f()"  
}
```

The **unqualified name lookup** is the mechanism by which the compiler searches for the declaration of an identifier without using any explicit scope qualifiers like the `::` operator

Unqualified name lookup and using namespace-Directive:

Every name from `namespace-name` is visible as if it is declared in the nearest enclosing namespace which contains both the `using`-directive and `namespace-name`

```
namespace A { int i = 0; }

namespace C {

int i = 3;
namespace B {
    using namespace A; // unqualified name lookup of A within B:
    int x = i;         // it is the nearest enclosing namespace which contains
} // namespace B     // both A and B -> global namespace
                    // "int x = i" -> "int x = C::i" because C has higher
} // namespace C     // precedence than the global namespace

int main() {
    using namespace B;
    cout << C::B::x; // print "3"
}
```

inline Namespace ★

`inline namespace` is a concept similar to library versioning. It is a mechanism that makes a nested namespace look and act as if all its declarations were in the surrounding namespace

```
namespace my_namespace1 {  
  
    inline namespace V99 { void f(int) {} } // most recent version  
    namespace          V98 { void f(int) {} }  
  
} // namespace my_namespace1  
  
using namespace my_namespace1;  
V98::f(1); // call V98  
V99::f(1); // call V99  
f(1);     // call default version (V99)
```

Attributes ★

C++ Attribute Overview

C++ attributes provide additional information to the compiler to enforce constraints or enable code optimization

Attributes are *annotation* on top of standard code that can be applied to functions, variables, classes, enumerator, types, etc.

C++11 introduces a standardized syntax for *attributes*: `[[my-attribute]]`

```
__attribute__((always_inline)) // < C++11, GCC/Clang/GNU compilers
__forceinline                 // < C++11, MSVC

[[gnu::always_inline]]       // C++11, GCC/Clang/GNU compilers
[[msvc::forceinline]]        // C++11, MSVC
```

In addition, C++11 and later add *standard attributes* [↗](#) such as `maybe_unused`, `deprecated`, and `nodiscard`

C++17 introduces the attribute `[[nodiscard]]` to issue a warning if the return value of a function is discarded (not handled)

C++20 extends the attribute by allowing to add a reason

```
[[nodiscard("reason")]]
```

```
[[nodiscard]] bool empty();
```

```
empty(); // WARNING "discard return value"
```

C++23 adds the `[[nodiscard]]` attribute to lambda expressions

```
auto lambda = [] [[nodiscard]] () { return 4; };
```

```
lambda(); // compiler warning
```

```
auto x = lambda(); // ok
```

[[nodiscard]] can be also be applied to enumerators `enum / enum class` and structures `struct / class`

```
enum class [[nodiscard]] MyEnum { EnumValue };
```

```
struct [[nodiscard]] MyStruct {};
```

```
MyEnum f() { return MyEnum::EnumValue; }
```

```
MyStruct g() {  
    MyStruct s;  
    return s;  
}
```

```
f(); // WARNING "discard return value"
```

```
g(); // WARNING "discard return value"
```

[[nodiscard]] can be also be applied to class constructors

```
MyStruct g() {  
    [[nodiscard]] MyStruct() {}  
    [[nodiscard]] MyStruct(const MyStruct&) {}  
}  
  
MyStruct{}; // WARNING "discard return value"  
MyStruct s{};  
static_cast<MyStruct>(s); // WARNING "discard return value" for  
                          // MyStruct(const MyStruct&)
```

[[maybe_unused]]  applies to

- Variables
- Structure binding
- Functions parameters and return value
- Types
- Classes and structures
- Enumerators and single value enumerators

```
[[maybe_unused]] int x1;  
  
[[maybe_unused]] auto [x2, x3] = ...;  
  
[[maybe_unused]] int f([[maybe_unused]] int x4);  
  
[[maybe_unused]] struct S {};  
  
using MyInt [[maybe_unused]] = int;  
  
enum [[maybe_unused]] Enum {  
    E1 [[maybe_unused]];  
};  
  
enum class [[maybe_unused]] EnumClass {  
    E2 [[maybe_unused]];  
};
```

C++14 allows to deprecate, namely discourage, use of entities by adding the `[[deprecated]]` attribute, optionally with a message `[[deprecated("reason")]]`. It applies to:

- Functions
- Variables
- Classes and structures
- Enumerators
- Single value enumerator in C++17
- Types
- Namespaces

```
[[deprecated]] void f() {}

struct [[deprecated]] S1 {};

using MyInt [[deprecated]] = int;

struct S2 {
    [[deprecated]] int var = 3;
    [[deprecated]] static constexpr int var2 = 4;
};

f();           // compiler warning
S1 s1;        // compiler warning
MyInt i;      // compiler warning
S2{}.var;     // compiler warning
S2::var2;    // compiler warning
```

C++17 allows to deprecate individual enumerator values

```
enum [[deprecated]] E { EnumValue };           // C++14

enum class MyEnum { A, B [[deprecated]] = 42 }; // C++17

auto x = EnumValue; // compiler warning
MyEnum::B;          // compiler warning
```

C++17 allows defining attribute on namespaces

```
namespace [[deprecated("please use my_namespace_v2")] my_namespace {  
  
void f() {}  
  
} // namespace my_namespace  
  
my_namespace::f(); // compiler warning
```

[[noreturn]] Attribute

[[noreturn]] indicates that a function *does not return* (e.g. program termination) and the compiler should issue a compiler warning if the code contains other statements that cannot be executed because it means a wrong user intention

```
[[noreturn]] void g() { std::exit(0); }
```

```
g(); // WARNING: no code should be executed after calling this function
```

```
y = x + 1;
```

Modern C++ Programming

5. BASIC CONCEPTS IV

MEMORY CONCEPTS

Federico Busato

2024-11-05

1 Pointers

- Pointer Operations
- Address-of operator &

2 Heap and Stack

- Stack Memory
- `new`, `delete`
- Non-Allocating Placement Allocation ★
- Non-Throwing Allocation ★
- Memory Leak

3 Initialization

- Variable Initialization
- Uniform Initialization
- Array Initialization
- Structure Initialization
- Structure Binding
- Dynamic Memory Initialization

4 References

5 `const` and Constant Expressions

- Constants and Literals
 - `const`
 - `constexpr`
 - `constexpr`
 - `constexpr`
 - `constexpr`
 - `if constexpr`
 - `std::is_constant_evaluated()`
 - `if constexpr`

6 volatile Keyword ★

7 Explicit Type Conversion

- `static_cast`
- `const_cast`
- `reinterpret_cast`
- Type Punning
- `std::bit_cast`
- Uniform Initialization Conversion
- `gls::narrow_cast` ★

8 sizeof Operator

- `[[no_unique_address]]`

Pointers

Pointer

A **pointer** `T*` is a value referring to a location in memory

Pointer Dereferencing

Pointer **dereferencing** (`*ptr`) means obtaining the value stored in at the location referred to the pointer

Subscript Operator []

The subscript operator (`ptr[]`) allows accessing to the pointer element at a given position

The **type of a pointer** (e.g. `void*`) is an *unsigned* integer of 32-bit/64-bit depending on the underlying architecture

- It only supports the operators `+`, `-`, `++`, `--`, comparisons `==`, `!=`, `<`, `<=`, `>`, `>=`, subscript `[]`, and dereferencing `*`
- A pointer can be *explicitly* converted to an integer type

```
void* x;  
size_t y = (size_t) x; // ok (explicit conversion)  
// size_t y = x;      // compile error (implicit conversion)
```

Pointer Conversion

- Any pointer type can be implicitly converted to `void*`
- Non-`void` pointers must be explicitly converted
- `static_cast`[†] does not allow pointer conversion for safety reasons, except for `void*`

```
int* ptr1 = ...;
void* ptr2 = ptr1;           // int* -> void*, implicit conversion

void* ptr3 = ...;
int* ptr4 = (int*) ptr3;    // void* -> int, explicit conversion required
                          // static_cast allowed

int* ptr5 = ...;
char* ptr6 = (char*) ptr5; // int* -> char*, explicit conversion required,
                          // static_cast not allowed, dangerous
```

[†] see `static_cast` section for further details

Dereferencing:

```
int* ptr1 = new int;  
*ptr1     = 4;    // dereferencing (assignment)  
int a     = *ptr1; // dereferencing (get value)
```

Array subscript:

```
int* ptr2 = new int[10];  
ptr2[2]   = 3;  
int var   = ptr2[4];
```

Common error:

```
int *ptr1, ptr2; // one pointer and one integer!!  
int *ptr1, *ptr2; // ok, two pointers
```

Subscript operator meaning:

`ptr[i]` is equal to `*(ptr + i)`

Note: subscript operator accepts also negative values

Pointer arithmetic rule:

`address(ptr + i) = address(ptr) + (sizeof(T) * i)`

where T is the type of elements pointed by ptr

```
int array[4] = {1, 2, 3, 4};
cout << array[1];      // print 2
cout << *(array + 1); // print 2
cout << array;         // print 0xFFFFAFF2
cout << array + 1;     // print 0xFFFFAFF6!!
int* ptr = array + 2;
cout << ptr[-1];      // print 2
```



```
char arr[4] = "abc"
```

| value | address | |
|-------|---------|---------|
| 'a' | 0x0 | ←arr[0] |
| 'b' | 0x1 | ←arr[1] |
| 'c' | 0x2 | ←arr[2] |
| '\0' | 0x3 | ←arr[3] |

```
int arr[3] = {4,5,6}
```

| value | address | |
|-------|---------|---------|
| 4 | 0x0 | ←arr[0] |
| | 0x1 | |
| | 0x2 | |
| | 0x3 | |
| 5 | 0x4 | ←arr[1] |
| | 0x5 | |
| | 0x6 | |
| | 0x7 | |
| 6 | 0x8 | ←arr[2] |
| | 0x9 | |
| | 0x10 | |
| | 0x11 | |

lib/vsprintf.c of the Linux kernel

```
int vsnprintf(char *buf, size_t size, ...) {
    char *end;
    /* Reject out-of-range values early
       Large positive sizes are used for unknown buffer sizes */
    if (WARN_ON_ONCE((int) size < 0))
        return 0;
    end = buf + size;
    /* Make sure end is always >= buf */
    if (end < buf) { ... } // Even if pointers are represented with unsigned values,
    ...                    // pointer overflow is undefined behavior.
                           // Both GCC and Clang will simplify the overflow check
                           // buf + size < buf to size < 0 by eliminating
    }                      // the common term buf
```

Address-of operator &

The **address-of operator** (&) returns the address of a variable

```
int a = 3;
int* b = &a; // address-of operator,
            // 'b' is equal to the address of 'a'
a++;
cout << *b; // print 4;
```

To not confuse with **Reference syntax**: `T& var = ...`

Wild and Dangling Pointers

Wild pointer:

```
int main() {  
    int* ptr;    // wild pointer: Where will this pointer points?  
    ...         // solution: always initialize a pointer  
}
```

Dangling pointer:

```
int main() {  
    int* array = new int[10];  
    delete[] array; // ok -> "array" now is a dangling pointer  
    delete[] array; // double free or corruption!!  
    // program aborted, the value of "array" is not null  
}
```

note:

```
int* array = new int[10];  
delete[] array; // ok -> "array" now is a dangling pointer  
array = nullptr; // no more dangling pointer  
delete[] array; // ok, no side effect
```

void Pointer - Generic Pointer

Instead of declaring different types of pointer variable it is possible to declare single pointer variable which can act as any pointer types

- `void*` can be compared
- Any pointer type can be implicitly converted to `void*`
- Other operations are unsafe because the compiler does not know what kind of object is really pointed to

```
cout << (sizeof(void*) == sizeof(int*)); // print true
```

```
int array[] = { 2, 3, 4 };
```

```
void* ptr = array; // implicit conversion
```

```
cout << *array; // print 2
```

```
// *ptr; // compile error
```

```
// ptr + 2; // compile error
```

Heap and Stack

Process Address Space

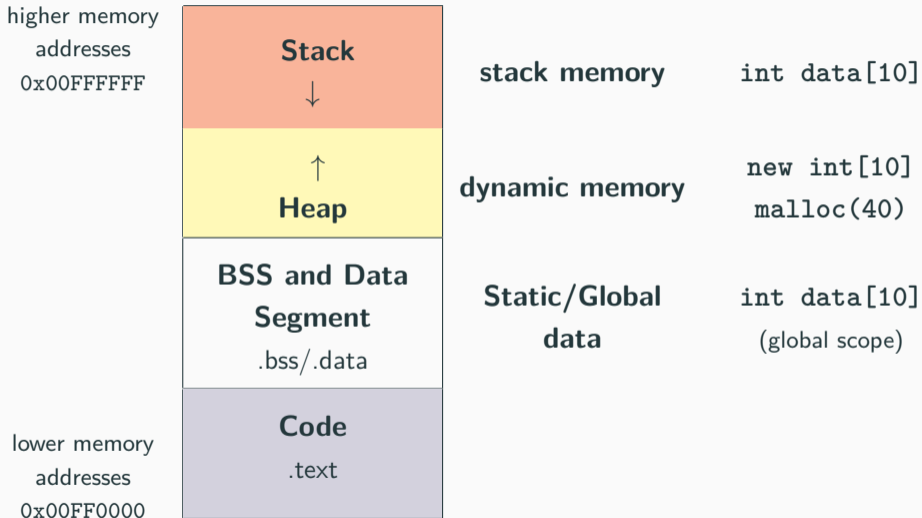

Data and BSS Segment

```
int data[]          = {1, 2}; // DATA segment memory
int big_data[1000000] = {};    // BSS segment memory
// (zero-initialized)

int main() {
    int A[] = {1, 2, 3}; // stack memory
}
```

Data/BSS (Block Started by Symbol) segments are larger than stack memory (max \approx 1GB in general) but slower

Stack and Heap Memory Overview

| | Stack | Heap |
|----------------------------|---|--|
| Memory Organization | Contiguous (LIFO) | Contiguous within an allocation, Fragmented between allocations (relies on virtual memory) |
| Max size | Small (8MB on Linux, 1MB on Windows) | Whole system memory |
| If exceed | Program crash at function entry (hard to debug) | Exception or <code>nullptr</code> |
| Allocation | Compile-time | Run-time |
| Locality | High | Low |
| Thread View | Each thread has its own stack | Shared among threads |

Stack Memory

A local variable is either in the stack memory or CPU registers

```
int x = 3; // not on the stack (data segment)

struct A {
    int k; // depends on where the instance of A is
};

int main() {
    int y = 3; // on stack
    char z[] = "abc"; // on stack
    A a; // on stack (also k)
    void* ptr = malloc(4); // variable "ptr" is on the stack
}
```

The organization of the stack memory enables much higher performance. On the other hand, this memory space is limited!!

Types of data stored in the stack:

Local variables Variable in a local scope

Function arguments Data passed from caller to a function

Return addresses Data passed from a function to a caller

Compiler temporaries Compiler specific instructions

Interrupt contexts

Stack Memory

Every object which resides in the stack is not valid outside his scope!!

```
int* f() {  
    int array[3] = {1, 2, 3};  
    return array;  
}  
int* ptr = f();  
cout << ptr[0]; // Illegal memory access!! ☠
```

```
void g(bool x) {  
    const char* str = "abc";  
    if (x) {  
        char xyz[] = "xyz";  
        str = xyz;  
    }  
    cout << str; // if "x" is true, then Illegal memory access!! ☠  
}
```

Heap Memory - new, delete Keywords

new, delete

`new/new[]` and `delete/delete[]` are C++ *keywords* that perform dynamic memory allocation/deallocation, and object construction/destruction at runtime

`malloc` and `free` are C functions and they only allocate and free *memory blocks* (expressed in bytes)

new, delete Advantages

- **Language keywords**, not functions → *safer*
- **Return type**: `new` returns exact data type, while `malloc()` returns `void*`
- **Failure**: `new` throws an *exception*, while `malloc()` returns a `NULL` pointer → *it cannot be ignored*, zero-size allocations do not need special code
- **Allocation size**: The number of bytes is calculated by the compiler with the `new` keyword, while the user must take care of manually calculate the size for `malloc()`
- **Initialization**: `new` can be used to initialize besides allocate
- **Polymorphism**: objects with `virtual` functions must be allocated with `new` to initialize the virtual table pointer

Dynamic Memory Allocation

- Allocate a single element

```
int* value = (int*) malloc(sizeof(int)); // C
int* value = new int;                    // C++
```

- Allocate N elements

```
int* array = (int*) malloc(N * sizeof(int)); // C
int* array = new int[N];                    // C++
```

- Allocate N structures

```
MyStruct* array = (MyStruct*) malloc(N * sizeof(MyStruct)); // C
MyStruct* array = new MyStruct[N];                          // C++
```

- Allocate and zero-initialize N elements

```
int* array = (int*) calloc(N, sizeof(int)); // C
int* array = new int[N] ();                // C++
```

Dynamic Memory Deallocation

- Deallocate a single element

```
int* value = (int*) malloc(sizeof(int)); // C
free(value);
```

```
int* value = new int; // C++
delete value;
```

- Deallocate N elements

```
int* value = (int*) malloc(N * sizeof(int)); // C
free(value);
```

```
int* value = new int[N]; // C++
delete[] value;
```

Allocation/Deallocation Properties

Fundamental rules:

- Each object allocated with `malloc()` must be deallocated with `free()`
- Each object allocated with `new` must be deallocated with `delete`
- Each object allocated with `new []` must be deallocated with `delete []`
- `malloc()`, `new`, `new []` never produce `NULL` pointer in the *success* case, except for zero-size allocations (implementation-defined)
- `free()`, `delete`, and `delete []` applied to `NULL` / `nullptr` pointers do not produce errors

Mixing `new`, `new []`, `malloc` with something different from their counterparts leads to *undefined behavior*

Easy on the stack - dimensions known at compile-time:

```
int A[3][4]; // C/C++ uses row-major order: move on row elements, then columns
```

Dynamic Memory 2D allocation/deallocation - dimensions known at run-time:

```
int** A = new int*[3]; // array of pointers allocation
for (int i = 0; i < 3; i++)
    A[i] = new int[4]; // inner array allocations

for (int i = 0; i < 3; i++)
    delete[] A[i]; // inner array deallocations
delete[] A; // array of pointers deallocation
```

Dynamic memory 2D allocation/deallocation C++11:

```
auto A = new int[3][4];    // allocate 3 objects of type int[4]
int n = 3;                // dynamic value
auto B = new int[n][4];   // ok
// auto C = new int[n][n]; // compile error
delete[] A;               // same for B, C
```

A **non-allocating placement** `(ptr) type` allows to explicitly specify the memory location (previously allocated) of individual objects

```
// STACK MEMORY  
char    buffer[8];  
int*    x = new (buffer) int;  
short*  y = new (x + 1) short[2];  
// no need to deallocate x, y
```

```
// HEAP MEMORY  
unsigned* buffer2 = new unsigned[2];  
double*   z       = new (buffer2) double;  
delete[]  buffer2; // ok  
// delete[] z;    // ok, but bad practice
```

Placement allocation of *non-trivial objects* requires to explicitly call the object destructor as the runtime is not able to detect when the object is out-of-scope

```
struct A {  
    ~A() { cout << "destructor"; }  
};  
  
char buffer[10];  
auto x = new (buffer) A();  
// delete x; // runtime error 'x' is not a valid heap memory pointer  
x->~A();    // print "destructor"
```

C++23 introduces a type safe placement allocation function

`std::start_lifetime_as()` ↗

Non-Throwing Allocation ★

The `new` operator allows a non-throwing allocation by passing the `std::nothrow` object. It returns a `NULL` pointer instead of throwing `std::bad_alloc` exception if the memory allocation fails

```
int* array = new (std::nothrow) int[very_large_size];
```

note: `new` can return `NULL` pointer even if the allocated size is 0

`std::nothrow` doesn't mean that the allocated object(s) cannot throw an exception itself

```
struct A {  
    A() { throw std::runtime_error{}; }  
};  
A* array = new (std::nothrow) A; // throw std::runtime_error
```

Memory Leak

Memory Leak

A **memory leak** is a dynamically allocated entity in the heap memory that is no longer used by the program, but still maintained overall its execution

Problems:

- Illegal memory accesses → segmentation fault/wrong results
- Undefined values and their propagation → segmentation fault/wrong results
- Additional memory consumption (potential segmentation fault)

```
int main() {  
    int* array = new int[10];  
    array      = nullptr; // memory leak!!  
} // the memory can no longer be deallocated!!
```

Note: the memory leaks are especially difficult to detect in complex code and when objects are widely used

Dynamic Memory Allocation and OS

A program does not directly allocate memory itself but, it asks for a chunk of memory to the OS. The OS provides the memory at the granularity of *memory pages* (virtual memory), e.g. 4KB on Linux

Implication: out-of-bound accesses do not always lead to segmentation fault (lucky case). The worst case is an execution with undefined behavior

```
int* x          = new int;
int num_iters = 4096 / sizeof(int); // 4 KB

for (int i = 0; i < num_iters; i++)
    x[i] = 1; // ok, no segmentation fault
```

Initialization

Variable Initialization

C++03:

```
int a1;           // default initialization (undefined value)

int a2(2);        // direct (or value) initialization

int a3(0);        // direct (or value) initialization (zero-initialization)
// int a4();      // a4 is a function

int a5 = 2;       // copy initialization

int a6 = 2u;      // copy initialization (+ implicit conversion)

int a7 = int(2);  // copy initialization

int a8 = int();   // copy initialization (zero-initialization)

int a9 = {2};     // copy list initialization, brace-initialization/braced-init-list syntax
```

Uniform Initialization

C++11 Uniform Initialization [↗](#) syntax allows to initialize different entities (variables, objects, structures, etc.) in a consistent way with brace-initialization or braced-init-list syntax:

```
int b1{2};           // direct list (or value) initialization
int b2{};           // direct list (or value) initialization (default constructor/
                    //                               zero-initialization)
int b3 = int{};     // copy initialization (default constr./zero-initialization)
int b4 = int{4};    // copy initialization

int b5 = {};        // copy list initialization (default constr./zero-initialization)
```

Brace Initialization Advantages

The **uniform initialization** can be also used to *safely* convert arithmetic types, preventing implicit *narrowing*, i.e potential value loss. The syntax is also more concise than modern casts

```
int      b4 = -1; // ok
int      b5{-1}; // ok
unsigned b6 = -1; // ok
//unsigned b7{-1}; // compile error

float    f1{10e30}; // ok
float    f2 = 10e40; // ok, "inf" value
//float  f3{10e40}; // compile error
```

Arrays are *aggregate* types and can be initialized with brace-initialization syntax, also called braced-init-list or aggregate-initialization

One dimension:

```
int a[3] = {1, 2, 3}; // explicit size
int b[] = {1, 2, 3}; // implicit size
char c[] = "abcd"; // implicit size
int d[3] = {1, 2}; // d[2] = 0 -> zero/default value

int e[4] = {0}; // all values are initialized to 0
int f[3] = {}; // all values are initialized to 0 (C++11)
int g[3] {}; // all values are initialized to 0 (C++11)
```

Two dimensions:

```
int a[][2] = { {1,2}, {3,4}, {5,6} }; // ok
int b[][2] = { 1, 2, 3, 4 };          // ok
// the type of "a" and "b" is an array of type int[]

// int c[][] = ...;                  // compile error
// int d[2][] = ...;                 // compile error
```

Structures are also *aggregate* types and can be initialized with brace-initialization syntax, also called braced-init-list or aggregate-initialization

```
struct S {
    unsigned x;
    unsigned y;
};

S s1;           // default initialization, x,y undefined values
S s2 = {};     // copy list initialization, x,y default constr./zero-init
S s3 = {1, 2}; // copy list initialization, x=1, y=2
S s4 = {1};    // copy list initialization, x=1, y default constr./zero-init
//S s5(3, 5); // compiler error, constructor not found

S f() {
    S s6 = {1, 2}; // verbose
    return s6;
}
```

```
struct S {  
    unsigned x;  
    unsigned y;  
    void* ptr;  
};  
  
S s1{};           // direct list (or value) initialization  
                 //      x,y,ptr default constr./zero-initialization  
  
S s2{1, 2};      // direct list (or value) initialization  
                 //      x=1, y=2, ptr default constr./zero-initialization  
  
// S s3{1, -2}; // compile error, narrowing conversion  
  
S f() { return {3, 2}; } // non-verbose
```

Non-Static Data Member Initialization (NSDMI) [↗](#), also called *brace or equal initialization*:

```
struct S1 {
    unsigned x = 3; // equal initialization
    unsigned y = 2; // equal initialization
// auto    z = 3; // auto is not allowed for non-static member variables
};
struct S2 {
    unsigned x {3}; // brace initialization
};
//-----
S1 s1;           // call the default constructor (x=3, y=2)
S1 s2{};        // call the default constructor (x=3, y=2)
S1 s3{1, 4};    // set x=1, y=4
S2 s4;          // call the default constructor (x=3)
S2 s5{5};       // set x=5
```

C++20 introduces the `designated initializer list` [↗](#)

```
struct A {  
    int x, y, z;  
};  
A a1{1, 2, 3}; // is the same of  
A a2{.x = 1, .y = 2, .z = 3}; // designated initializer list
```

Designated initializer list can be very useful for improving code readability

```
void f1(bool a, bool b, bool c, bool d, bool e) {}  
// long list of the same data type -> error-prone  
  
struct B {  
    bool a, b, c, d, e;  
}; // f2(B b)  
f2({.a = true, .c = true}); // b, d, e = false
```

Structure Binding

Structure Binding declaration C++17 binds the specified names to elements of initializer:

```
struct A {  
    int x = 1;  
    int y = 2;  
} a;  
A f() { return A{4, 5}; }  
  
// Case (1): struct  
auto [x1, y1] = a; // x1=1, y1=2  
auto [x2, y2] = f(); // x2=4, y2=5  
int b[2] = {1,2}; // Case (2): raw arrays  
auto [x3, y3] = b; // x3=1, y3=2  
auto [x4, y4] = std::tuple<float, int>{3.0f, 2}; // Case (3): tuples  
  
// constexpr auto [x1, y1] = a; // constexpr structure binding is not allowed  
// because it relies on references
```

Dynamic Memory Initialization

Dynamic memory initialization applies the same rules of the object that is allocated

C++03:

```
int* a1 = new int;           // undefined
int* a2 = new int();        // zero-initialization, call "= int()"
int* a3 = new int(4);       // allocate a single value equal to 4
int* a4 = new int[4];       // allocate 4 elements with undefined values
int* a5 = new int[4]();     // allocate 4 elements zero-initialized, call "= int()"
// int* a6 = new int[4](3); // not valid
```

C++11:

```
int* b1 = new int[4]{};     // allocate 4 elements zero-initialized, call "= int{}"
int* b2 = new int[4]{1, 2}; // set first, second, zero-initialized
```

Initialization - Undefined Behavior Example ★

lib/libc/stdlib/rand.c of the FreeBSD libc

```
struct timeval tv;
unsigned long junk;           // not initialized, undefined value

/* XXX left uninitialized on purpose */
gettimeofday(&tv, NULL);
srandom((getpid() << 16) ^ tv.tv_sec ^ tv.tv_usec ^ junk);
    // A compiler can assign any value not only to the variable,
    // but also to expressions derived from the variable

    // GCC assigns junk to a register. Clang further eliminates computation
    // derived from junk completely, and generates code that does not use
    // either gettimeofday or getpid
```

References

Reference

A variable **reference** `T&` is an **alias**, namely another name for an already existing variable. Both variable and variable reference can be applied to refer the value of the variable

- A pointer has its own memory address and size on the stack, reference shares the **same memory address** (with the original variable)
- The compiler can internally implement references as *pointers*, but treats them in a very different way

References are safer than pointers:

- References cannot have NULL value. You must always be able to assume that a reference is connected to a legitimate storage
- References cannot be changed. Once a reference is initialized to an object, it cannot be changed to refer to another object
(Pointers can be pointed to another object at any time)
- References must be initialized when they are created
(Pointers can be initialized at any time)

Reference - Examples

Reference syntax: `T& var = ...`

```
//int& a;      // compile error no initialization  
//int& b = 3;  // compile error "3" is not a variable  
int c = 2;  
int& d = c;   // reference. ok valid initialization  
int& e = d;   // ok. the reference of a reference is a reference  
++d;         // increment  
++e;         // increment  
cout << c;   // print 4
```

```
int a = 3;  
int* b = &a; // pointer  
int* c = &a; // pointer  
++b;        // change the value of the pointer 'b'  
++*c;       // change the value of 'a' (a = 4)  
int& d = a; // reference  
++d;        // change the value of 'a' (a = 5)
```

Reference vs. pointer arguments:

```
void f(int* value) {} // value may be a nullptr

void g(int& value) {} // value is never a nullptr

int a = 3;
f(&a);    // ok
f(0);    // dangerous but it works!! (but not with other numbers)
//f(a);  // compile error "a" is not a pointer

g(a);    // ok
//g(3);  // compile error "3" is not a reference of something
//g(&a); // compile error "&a" is not a reference
```

References can be use to indicate fixed size arrays:

```
void f(int (&array)[3]) { // accepts only arrays of size 3
    cout << sizeof(array);
}

void g(int array[]) {
    cout << sizeof(array); // any surprise?
}

int A[3], B[4];
int* C = A;
//-----
f(A);    // ok
// f(B); // compile error B has size 4
// f(C); // compile error C is a pointer
g(A);    // ok
g(B);    // ok
g(C);    // ok
```

Reference - Arrays★

```
int A[4];
int (&B)[4] = A;    // ok, reference to array
int C[10][3];
int (&D)[10][3] = C; // ok, reference to 2D array

auto c = new int[3][4]; // type is int (*)[4]
// read as "pointer to arrays of 4 int"
// int (&d)[3][4] = c; // compile error
// int (*e)[3] = c; // compile error
int (*f)[4] = c; // ok
```

```
int array[4];
// &array is a pointer to an array of size 4
int size1 = (&array)[1] - array;
int size2 = *(&array + 1) - array;
cout << size1; // print 4
cout << size2; // print 4
```

struct Member Access

- The **dot** (.) operator is applied to local objects and references
- The **arrow** operator (->) is used with a pointer to an object

```
struct A {  
    int x;  
};  
  
A a;           // local object  
a.x;          // dot syntax  
  
A& ref = a;   // reference  
ref.x;        // dot syntax  
  
A* ptr = &a;  // pointer  
ptr->x;       // arrow syntax: same of *ptr.x
```

const and Constant Expressions

Constants and Literals

A **constant expression** \varnothing is an expression that can be *evaluated at compile-time*

A **literal** \varnothing is a *fixed value* that can be assigned to a *constant*

formally, “*Literals are the tokens of a C++ program that represent constant values embedded in the source code*”

Literal types:

- **Concrete values** of the scalar types `bool`, `char`, `int`, `float`, `double`, e.g. `true`, `'a'`, `3`, `2.0f`
- **String literal** of type `const char[]`, e.g. `"literal"`
- `nullptr`
- User-defined literals, e.g. `2s`

const Keyword

const keyword

The `const` [↗](#) keyword declares an object that never changes value after the initialization. A `const` variable must be initialized when declared

A `const` variable is evaluated at compile-time value if the right expression is also evaluated at compile-time

```
int size = 3;           // 'size' is dynamic
int A[size] = {1, 2, 3}; // technically possible but, variable size stack array
                        // are considered BAD programming

const int SIZE = 3;
// SIZE = 4;           // compile error, SIZE is const
int B[SIZE] = {1, 2, 3}; // ok

const int size2 = size; // 'size2' is dynamic
```

- `int* → const int*`
- `const int* ↗ int*`

```
void read(const int* array) {} // the values of 'array' cannot be modified

void write(int* array) {}

int* ptr = new int;
const int* const_ptr = new int;
read(ptr); // ok
write(ptr); // ok
read(const_ptr); // ok
// write(const_ptr); // compile error
```

- `int*` pointer to `int`
 - The value of the pointer can be modified
 - The elements referred by the pointer can be modified
- `const int*` pointer to `const int`. Read as `(const int)*`
 - The value of the pointer can be modified
 - The elements referred by the pointer cannot be modified
- `int *const` const pointer to `int`
 - The value of the pointer cannot be modified
 - The elements referred by the pointer can be modified
- `const int *const` const pointer to `const int`
 - The value of the pointer cannot be modified
 - The elements referred by the pointer cannot be modified

Note: `const int*` (*West notation*) is equal to `int const*` (*East notation*)

Tip: pointer types should be read from right to left

Common error: adding `const` to a pointer is not the same as adding `const` to a type alias of a pointer

```
using ptr_t      = int*;
using const_ptr_t = const int*;

void f1(const int* ptr) { // read as '(const int)*'
// ptr[0] = 0;           // not allowed: pointer to const objects
    ptr = nullptr;      // allowed
}

void f2(const_ptr_t ptr) {} // same as before

void f3(const ptr_t ptr) { // warning!! equal to 'int* const'
    ptr[0] = 0;           // allowed!!
// ptr = nullptr;       // not allowed: const pointer to modifiable objects
}
```

constexpr (C++11)

`constexpr` [↗](#) specifier declares an expression that can be evaluated at compile-time

- `constexpr` can improve performance and memory usage
- `constexpr` can potentially impact the compilation time

constexpr Variable

`constexpr` variables are always evaluated at compile-time

- `const` guarantees the value of a variable cannot change after the initialization
- `constexpr` implies `const`

```
const int v1 = 3;           // compile-time evaluation
const int v2 = v1 * 2;     // compile-time evaluation

int      a  = 3;           // "a" is dynamic
const int v3 = a;         // run-time evaluation!!

constexpr int c1 = v1;    // ok
// constexpr int c2 = v3; // compile error, "v3" is a run-time variable
```

constexpr Function

`constexpr` guarantees compile-time evaluation of a function as long as all its arguments are evaluated at compile-time

```
constexpr int square(int value) {  
    return value * value;  
}  
square(4); // compile-time evaluation, '4' is a literal  
int a = 4; // "a" is dynamic  
square(a); // run-time evaluation
```

- C++11: must contain exactly one `return` statement, and no loops or `switch`
- C++14: no restrictions

A `constexpr` function is always *evaluated at run-time* if:

- contains run-time arguments with a lifetime that begins with the expression, even if the function doesn't depend on them

```
constexpr int f(int v) { return 3; }
constexpr int g(int& v) { return 3; }
int v = ...
f(v); // run-time evaluation
g(v); // compile-time evaluation lifetime of 'v' began outside the expression
```

- contains run-time functions, namely non-`constexpr` functions (detected with `-Winvalid-constexpr`)
- contains references to run-time global variables

- cannot contain run-time features such as *exceptions* and *RTTI*
- cannot contain `assert()` until C++14
- cannot be a `virtual` member function or a destructor `~T` until C++20
- cannot contain or `try-catch` blocks or `asm` statements until C++20
- cannot contain `static` variables or `goto` until C++23
- undefined behavior code is not allowed, e.g. `reinterpret_cast`, unsafe usage of `union`, signed integer overflow, etc.

`constexpr` *non-static member functions* of run-time objects cannot be used at compile-time if they contain data members or non-compile-time functions

Note: `static constexpr` *member functions* don't present this issue because they don't depend on a specific instance

```
struct A {
    int v = 3;
    constexpr int f() const { return v; }
    static constexpr int g() { return 3; }
};
A a1;
// constexpr int x = a1.f(); // compile error, f() is evaluated at run-time
constexpr int y = a1.g(); // ok, same as 'A::g()'

constexpr A a2;
constexpr int x = a2.f(); // ok
```

constexpr Keyword

constexpr (C++20)

`constexpr` [↗](#), or *immediate function*, guarantees compile-time evaluation.

A run-time value always produces a compile error

```
constexpr int square(int value) {  
    return value * value;  
}  
  
square(4);    // compile-time evaluation  
  
int v = 4;    // "v" is at run-time  
// square(v); // compile error
```

constexpr Keyword

constexpr (C++20)

`constexpr` [↗](#) guarantees compile-time initialization of a variable. A run-time initialization value always produces a compile error

- The value of a variable can change during the execution
- `const constexpr` does not imply `constexpr`, while the opposite is true

```
constexpr int square(int value) {  
    return value * value;  
}  
  
constexpr int v1 = square(4);    // compile-time evaluation  
v1 = 3;                          // ok, v1 can change  
  
int a = 4;                        // "v" is dynamic  
// constexpr int v2 = square(a); // compile error
```

if constexpr

`if constexpr` ↗ C++17 allows to *conditionally* compile code based on a *compile-time* predicate

The `if constexpr` statement forces the compiler to evaluate the branch at compile-time (similarly to the `#if` preprocessor)

```
auto f() {  
    if constexpr (sizeof(void*) == 8)  
        return "hello";           // const char*  
    else  
        return 3;                 // int, never compiled  
}
```

Note: Ternary (conditional) operator does not provide `constexpr` variant

if constexpr Example

```
constexpr int fib(int n) {  
    return (n == 0 || n == 1) ? 1 : fib(n - 1) + fib(n - 2);  
}  
  
int main() {  
    if constexpr (sizeof(void*) == 8)  
        return fib(5);  
    else  
        return fib(3);  
}
```

Generated assembly code (x64 OS):

```
main:  
    mov eax, 8  
    ret
```

if constexpr Pitfalls

`if constexpr` only works with *explicit* `if/else` statements

```
auto f1() {  
    if constexpr (my_constexpr_fun() == 1)  
        return 1;  
    // return 2.0; compile error // this is not part of constexpr  
}
```

`else if` branch requires `constexpr`

```
auto f2() {  
    if constexpr (my_constexpr_fun() == 1)  
        return 1;  
    else if (my_constexpr_fun() == 2) // -> else if constexpr  
    //     return 2.0; compile error // this is not part of constexpr  
    else  
        return 3L;  
}
```

`std::is_constant_evaluated()`

C++20 provides `std::is_constant_evaluated()` utility to evaluate if the current function is evaluated at compile time

```
#include <type_traits> // std::is_constant_evaluated

constexpr int f(int n) {
    if (std::is_constant_evaluated())
        return 0;
    return 4;
}

f(3); // return 0

int v = 3;
f(v); // return = 4
```

`std::is_constant_evaluated()` has two problems that `if constexpr` [C++23](#) solves:

- (1) Calling a `constexpr` function cannot be used within a `constexpr` function if it is called with a run-time parameter

```
constexpr int g(int n) { return n * 3; }

constexpr int f(int n) {
    if (std::is_constant_evaluated()) // it works with if constexpr
        return g(n);
    return 4;
}

// f(3); compiler error
```

(2) `if constexpr (std::is_constant_evaluated())` is a bug because it is always evaluated to `true`

```
constexpr int f(int x) {
    if constexpr (std::is_constant_evaluated()) // if consteval avoids this error
        return 3;
    return 4;
}

constexpr int g(int x) {
    if consteval {
        return 3;
    }
    return 4;
}
```

`volatile` **Keyword** ★

volatile Keyword

volatile

`volatile` is a hint to the compiler to avoid aggressive memory optimizations involving a pointer or an object

Use cases:

- *Low-level programming*: driver development, interaction with assembly, etc. (force writing to a specific memory location)
- *Multi-thread program*: variables shared between threads/processes to communicate (don't optimize, delay variable update)
- *Benchmarking*: some operations need to not be optimized away

Note: `volatile` reads/writes can still be reordered with respect to non-volatile ones

volatile Keyword - Example

The following code compiled with `-O3` (full optimization) and without `volatile` could work fine

```
volatile int* ptr = new int[1];           // actual allocation size is much
int          pos = 128 * 1024 / sizeof(int); // larger, typically 128 KB
ptr[pos]     = 4;                         // 🦴 segfault
```

volatile Deprecation

C++20 deprecates `volatile` outside single load and store operations

```
volatile int v = 3;
auto      v1 = v + 4; // ok, one load
v         = 4;      // ok, one store
v         += 4;     // deprecated, load + store

volatile int f() {} // deprecated, volatile return value

void g1(volatile int) {} // deprecated, volatile argument

void g2(volatile int*) {} // ok

struct A {
    volatile int x = 4; // deprecated, volatile data member
};
```

Explicit Type Conversion

`static_cast` converts between types and performs compile-time (not run-time) type check

It is equivalent to the **old style cast** `(T) var` or `T(var)` for *value semantic*

```
int    a  = 6;
short  b1 = (short) a;           // the compiler can issue a warning without
short  b2 = short(a);           // explicit cast
short  b3 = static_cast<int>(a);
long   c  = a;                   // not needed
```

`static_cast` prevents accidental/unsafe conversions between pointer types, especially across classes in a hierarchy

```
char* a = new char[4]{1, 2, 3, 4};  
int* b = (int*) a; // ok  
cout << b[0]; // print 67305985, not 1!!  
//int* c = static_cast<int*>(a); // compile error unsafe conversion
```

`static_cast` also prevents accidental/unsafe `const` conversions

```
const char* a = new char;  
char* b = (char*) a; // ok  
//char* c = static_cast<char*>(a); // compile error unsafe conversion
```

`static_cast` prevents accidental/unsafe conversions between unrelated classes

```
struct A {};  
struct B : A {};  
struct C {};  
  
A    a;  
B    b;  
auto x1 = (A&) b;           // ok  
auto x2 = (C&) a;           // ok  
auto x3 = (C*) &a;         // ok  
auto x4 = static_cast<A&>(b); // ok  
//auto x5 = static_cast<C&>(a); // compile error unsafe conversion  
//auto x6 = static_cast<C*>(&a); // compile error unsafe conversion
```

Note: `(T&) v` is equal to `*((T*) &v)`

`const_cast` can add or cast away (remove) constness or volatility

```
const int* ptr = new int[4];
auto      x1  = (int*) ptr ;           // ok
auto      x2  = (char*) ptr;          // ok
auto      x3  = const_cast<int*>(ptr); // ok
//auto     x4  = const_cast<char*>(ptr); // compile error unsafe conversion

const int    a  = 5;
const_cast<int>(a) = 3; // ok, but undefined behavior

int          b  = 5;
const_cast<volatile int>(b) = 3; // ok
```

`reinterpret_cast` allows a subset of unsafe conversion:

- between pointers/references of different type with same constness
- between pointers and integer types

```
float b = 3.0f;           // bits: 01000000010000000000000000000000
int   c = reinterpret_cast<int&>(b); // bits: 01000000010000000000000000000000

const int* ptr = new int;
//reinterpret_cast<int*>(ptr); // compile error
uintptr_t my_int = reinterpret_cast<uintptr_t>(ptr); // ok

// ARRAY RESHAPING
int a[3][4];
int (&b)[2][6] = reinterpret_cast<int (&)[2][6]>(a);
int (*c)[6] = reinterpret_cast<int (*)[6]>(a);
```

Pointer Aliasing

One pointer **aliases** another when they both point to the same memory location

Type Punning

Type punning refers to circumvent the type system of a programming language to achieve an effect that would be difficult or impossible to achieve within the bounds of the formal language

The compiler assumes that the ***strict aliasing rule*** is never violated: Accessing a value using a type which is different from the original one is not allowed and it is classified as *undefined behavior*

```
// slow without optimizations. The branch breaks the CPU instruction pipeline  
float abs(float x) {  
    return (x < 0.0f) ? -x : x;  
}  
  
// optimized with bitwise operation  
float abs(float x) {  
    unsigned uvalue = reinterpret_cast<unsigned&>(x);  
    unsigned tmp    = uvalue & 0x7FFFFFFF; // clear the last bit  
    return reinterpret_cast<float&>(tmp);  
}  
  
// this is undefined behavior!!
```

GCC warning (not clang): `-Wstrict-aliasing`

-
- blog.qt.io/blog/2011/06/10/type-punning-and-strict-aliasing
 - What is the Strict Aliasing Rule and Why do we care?
 - Type Punning In C++17

std::bit_cast

The right way to avoid undefined behavior is by using `memcpy`

```
#include <cstring> // std::memcpy
float    v1 = 32.3f;
unsigned v2;
std::memcpy(&v2, &v1, sizeof(float));
```

Problems: `memcpy` is unsafe if the variables have not the same size or are not *trivially copyable*. Also, it doesn't work at compile-time (`constexpr`)

C++20 `std::bit_cast` provides a safe alternative to `reinterpret_cast` and `memcpy` that also works at compile-time

```
#include <bit> // std::bit_cast
constexpr float    v1 = 32.3f;
constexpr unsigned v2 = std::bit_cast<unsigned>(v1);
```

Uniform Initialization Conversion

A **narrowing conversion** occurs when the destination type may not be able to represent all the values of the source type

Brace initialization `{}` C++11 disallows narrowing conversions

```
// RUN-TIME VALUES
int      a = 3;
long long x1{a}; // ok
//unsigned x2{a}; // compile error, 'a' could be negative
//float    x3{a}; // compile error, 'a' could not be representable with float

double   b = 3;
//long long x4{b}; // compile error, 'b' could be a number with decimals
//float     x5{b}; // compile error, 'b' could not be representable with float
```

gcc issues a warning instead of a compile error for run-time narrowing conversions

Uniform Initialization Conversion

```
// COMPILE-TIME VALUES
constexpr int c = 3;
unsigned     x6{c};    // ok

constexpr int d = -1;
unsigned     x7{d};    // compile error, 'd' is negative

constexpr float e = 4;
//int        x8{e};    // compile error, 'float' cannot be narrowed to 'int'

constexpr double f = std::numbers::pi_v<double>; //  $\pi$ , C++20 <numbers>
float        x9{f};    // ok
constexpr double g = 1e+40;
//float      x10{g};   // compile error, too large for 'float'
```

The Guidelines Support Library (GSL) [↗](#) contains functions and types that are suggested for use by the C++ Core Guidelines [↗](#) maintained by the Standard C++ Foundation

GLS offers `narrow_cast` operation for specifying that narrowing is acceptable and a `narrow` (“narrow if”) that throws an exception if a narrowing would throw away legal values

```
#include <gsl/gsl>

double a = 1.1;
int     x1 = gsl::narrow_cast<int>(d); // ok, explicit narrowing: 'a' becomes 1
int     x2 = gsl::narrow<int>(d);      // ok, throws 'narrowing_error'
```

sizeof Operator

sizeof operator

sizeof

The `sizeof` is a compile-time operator that determines the size, in bytes, of a variable or data type

- `sizeof` returns a value of type `size_t`
- `sizeof(anything)` never returns 0 (*except for arrays of size 0)
- `sizeof(char)` always returns 1
- When applied to structures, it also takes into account the internal padding
- When applied to a reference, the result is the size of the referenced type
- `sizeof(incomplete type)` produces compile error, e.g. `void`
- `sizeof(bitfield member)` produces compile error

* `gcc` allows array of size 0 (not allowed by the C++ standard)

```
sizeof(int);    // 4 bytes
sizeof(int*)    // 8 bytes on a 64-bit OS
sizeof(void*)   // 8 bytes on a 64-bit OS
sizeof(size_t)  // 8 bytes on a 64-bit OS
```

```
int f(int array[]) {           // dangerous!!
    cout << sizeof(array);
}
```

```
int array1[10];
int* array2 = new int[10];
cout << sizeof(array1); // sizeof(int) * 10 = 40 bytes
cout << sizeof(array2); // sizeof(int*) = 8 bytes
f(array1);               // 8 bytes (64-bit OS)
```

```
struct A {
    int x; // 4-byte alignment
    char y; // offset 4
};
sizeof(A); // 8 bytes: 4 + 1 (+ 3 padding), must be aligned to its largest member

struct B {
    int x; // offset 0 -> 4-byte alignment
    char y; // offset 4 -> 1-byte alignment
    short z; // offset 6 -> 2-byte alignment
};
sizeof(B); // 8 bytes : 4 + 1 (+ 1 padding) + 2

struct C {
    short z; // offset 0 -> 2-byte alignment
    int x; // offset 4 -> 4-byte alignment
    char y; // offset 8 -> 1-byte alignment
};
sizeof(C); // 12 bytes : 2 (+ 2 padding) + 4 + 1 + (+ 3 padding)
```

```
char a;
char& b = a;
sizeof(&a);    // 8 bytes in a 64-bit OS (pointer)
sizeof(b);    // 1 byte, equal to sizeof(char)
              // NOTE: a reference is not a pointer

struct S1 {
    void* p;
};
sizeof(S1);   // 8 bytes

struct S2 {
    char& c;
};
sizeof(S2);   // 8 bytes, same as sizeof(void*)
sizeof(S2{}.c); // 1 byte
```

```
struct A {};  
sizeof(A);      // 1 : sizeof never return 0  
  
A array1[10];  
sizeof(array1); // 10 : array of empty structures  
  
int array2[0]; // C++ doesn't allow array of size 0, as opposed to C  
              // only gcc, compiler error for other compilers  
sizeof(array2); // 0 : special case
```

C++20 `[[no_unique_address]]` allows a structure member to be overlapped with other data members of a different type

```
struct Empty {}; // empty class, sizeof(Empty) == 1

struct A {      // sizeof(A) == 5 (4 + 1)
    int i;
    Empty e;
};

struct B {      // sizeof(B) == 4, 'e' overlaps with 'i'
    int i;
    [[no_unique_address]] Empty e;
};
```

Notes: `[[no_unique_address]]` is ignored by MSVC even in C++20 mode; instead, `[[msvc::no_unique_address]]` is provided

sizeof and Size of a Byte

Interesting: C++ does not explicitly define the size of a byte (see `Exotic architectures the standards committees care about`)

Modern C++ Programming

6. BASIC CONCEPTS V FUNCTIONS AND PREPROCESSING

Federico Busato

2024-11-05

1 Functions

- Pass by-Value
- Pass by-Pointer
- Pass by-Reference
- Function Signature and Overloading
- Overloading and `=delete`
- Default Parameters

2 Function Pointers and Function Objects

- Function Pointer
- Function Object (or Functor)

3 Lambda Expressions

- Capture List
- Lambda Expression and Function Relation
- Parameter Notes
- Composability
- Recursion
- `constexpr/constexpr`
- `template`
- `mutable`
- Capture List and Classes

4 Preprocessing

- Preprocessors
- Common Errors
- Source Location Macros
- Condition Compiling Macros
- Stringizing Operator #
- #error and #warning
- #pragma
- Token-Pasting Operator ## ★
- Variadic Macro ★

Functions

A **function** (**procedure** or **routine**) is a piece of code that performs a *specific task*

Purpose:

- **Avoiding code duplication:** less code for the same functionality → less bugs
- **Readability:** better express what the code does
- **Organization:** break the code in separate modules

Function Parameter and Argument

Function Parameter [formal]

A **parameter** is the variable which is part of the method signature

Function Argument [actual]

An **argument** is the actual value (instance) of the variable that gets passed to the function

```
void f(int a, char* b); // parameters: int a, char* b
                        // return type: void

f(3, "abc");           // arguments: 3, "abc"
```

Call-by-value

The object is copied and assigned to input arguments of the method `f(T x)`

Advantages:

- Changes made to the parameter inside the function have no effect on the argument

Disadvantages:

- Performance penalty if the copied arguments are large (e.g. a structure with several data members)

When to use:

- Built-in data type and small objects (≤ 8 bytes)

When not to use:

- Fixed size arrays which decay into pointers
- Large objects

Call-by-pointer

The address of a variable is copied and assigned to input arguments of the method

```
f(T* x)
```

Advantages:

- Allows a function to change the value of the argument
- The argument is not copied (fast)

Disadvantages:

- The argument may be a null pointer
- Dereferencing a pointer is slower than accessing a value directly

When to use:

- *Raw* arrays (use `const T*` if read-only)

When not to use:

- All other cases

Call-by-reference

The reference of a variable is copied and assigned to input arguments of the method
`f(T& x)`

Advantages:

- Allows a function to change the value of the argument (better readability compared with pointers)
- The argument is not copied (fast)
- References must be initialized (no null pointer)
- Avoid implicit conversion (without `const T&`)

When to use:

- All cases except raw pointers

When not to use:

- Pass by-value *could* give performance advantages and improve the readability with built-in data type and small objects that are trivially copyable

Examples

```
struct MyStruct;

void f1(int a);           // pass by-value
void f2(int& a);         // pass by-reference
void f3(const int& a);   // pass by-const reference
void f4(MyStruct& a);    // pass by-reference

void f5(int* a);         // pass by-pointer
void f6(const int* a);   // pass by-const pointer
void f7(MyStruct* a);    // pass by-pointer

void f8(int*& a);        // pass a pointer by-reference
//-----
char c = 'a';
f1(c);    // ok, pass by-value (implicit conversion)
// f2(c); // compile error different types
f3(c);    // ok, pass by-value (implicit conversion)
```

Signature

Function signature defines the *input types* for a (specialized) function and the *inputs + outputs types* for a template function

A function signature includes the number of arguments, the types of arguments, and the order of the arguments

- The C++ standard prohibits a function declaration that only differs in the return type
- Function declarations with different signatures can have distinct return types

Overloading

Function overloading allows having distinct functions with the same name but with different *signatures*

```
void f(int a, char* b);           // signature: (int, char*)

// char f(int a, char* b);       // compile error same signature
//                               // but different return types

void f(const int a, char* b);     // same signature, ok
//                               // const int == int

void f(int a, const char* b);     // overloading with signature: (int, const char*)

int f(float);                    // overloading with signature: (float)
//                               // the return type is different
```

GCC 14 adds the flag `-fdiagnostics-all-candidates` to show all function candidates when overload resolution failure occurs

Overloading Resolution Rules

- An exact match
- A promotion (e.g. `char` to `int`)
- A standard type conversion (e.g. `float` and `int`)
- A constructor or user-defined type conversion \rightsquigarrow

```
void f(int a);  
void f(float b); // overload  
void f(float b, char c); // overload  
//-----  
f(0); // exact match  
f('a'); // promotion from char to int (promotion)  
// f(3LL); // compile error ambiguous match  
f(2.3f); // exact match  
// f(2.3); // compile error ambiguous match  
f(2.3, 'a'); // standard type conversion, ambiguity is not possible here
```

Overloading and =delete

=delete can be used to prevent calling the wrong overload

```
void g(int) {}
```

```
void g(double) = delete;
```

```
g(3); // ok
```

```
g(3.0); // compile error
```

```
#include <cstddef> // std::nullptr_t
```

```
void f(int*) {}
```

```
void f(std::nullptr_t) = delete;
```

```
f(nullptr); // compile error
```

Function Default Parameters

Default/Optional parameter

A **default parameter** is a function parameter that has a default value

- If the user does not supply a value for this parameter, the default value will be used
- All default parameters must be the rightmost parameters
- Default parameters must be declared only once
- Default parameters can improve compile time and avoid redundant code because they avoid defining other overloaded functions

```
void f(int a, int b = 20);           // declaration

//void f(int a, int b = 10) { ... } // compile error, already set in the declaration

void f(int a, int b) { ... }       // definition, default value of "b" is already set

f(5); // b is 20
```

Function Pointers and Function Objects

Standard C achieves generic programming capabilities and composability through the concept of **function pointer**

A function can be passed as a pointer to another function and behaves as an *“indirect call”*

```
#include <stdlib.h> // qsort

int descending(const void* a, const void* b) {
    return *((const int*) a) > *((const int*) b);
}

int array[] = {7, 2, 5, 1};
qsort(array, 4, sizeof(int), descending);
// array: { 7, 5, 2, 1 }
```

```
int eval(int a, int b, int (*f)(int, int)) {  
    return f(a, b);  
}  
  
// type: int (*)(int, int)  
int add(int a, int b) { return a + b; }  
int sub(int a, int b) { return a - b; }  
  
cout << eval(4, 3, add); // print 7  
cout << eval(4, 3, sub); // print 1
```

Problems:

Safety There is no check of the argument type in the generic case (e.g. `qsort`)

Performance Any operation requires an indirect call to the original function. Function inlining is not possible

Function Object

A **function object**, or **functor**, is a *callable* object that can be treated as a parameter

C++ provides a more efficient and convenience way to pass “*procedure*” to other functions called **function object**

```
#include <algorithm> // for std::sort

struct Descending { // <-- function object
    bool operator()(int a, int b) { // function call operator
        return a > b;
    }
};

int array[] = {7, 2, 5, 1};
std::sort(array, array + 4, Descending{});
// array: { 7, 5, 2, 1 }
```

Advantages:

Safety Argument type checking is always possible. It could involve templates

Performance The compiler injects `operator()` in the code of the destination function and then compile the routine. Operator inlining is the standard behavior

C++11 simplifies the concept by providing less verbose function objects called **lambda expressions**

Lambda Expressions

Lambda Expression

Lambda Expression

A C++11 lambda expression is an *inline local-scope* function object

```
auto x = [capture clause] (parameters) { body }
```

- The [capture clause] marks the declaration of the lambda and how the local scope arguments are captured (by-value, by-reference, etc.)
- The parameters of the lambda are normal function parameters (optional in C++23*)
- The body of the lambda is a normal function body

The expression to the right of = is the **lambda expression**, and the runtime object x created by that expression is the **closure**

* some compilers support lambda expressions without parameters in previous C++ standards

Lambda Expression Examples

```
#include <algorithm> // for std::sort

int array[] = {7, 2, 5, 1};
auto lambda = [](int a, int b){ return a > b; }; // named lambda

std::sort(array, array + 4, lambda);
// array: { 7, 5, 2, 1 }

// in alternative, in one line of code:           // unnamed lambda
std::sort(array, array + 4, [](int a, int b){ return a > b; });
// array: { 7, 5, 2, 1 }

auto lambda2 = []{ return 3; };                   // no parameters, C++23
```

Capture List

Lambda expressions *capture* external variables used in the body of the lambda in two ways:

- Capture *by-value*
- Capture *by-reference* (can modify external variable values)

Capture list can be passed as follows

- `[]` no capture
- `[=]` captures all variables *by-value*
- `[&]` captures all variables *by-reference*
- `[var1]` captures only `var1` *by-value*
- `[&var2]` captures only `var2` *by-reference*
- `[var1, &var2]` captures `var1` *by-value* and `var2` *by-reference*

Capture List Examples

```
// GOAL: find the first element greater than "limit"
#include <algorithm> // for std::find_if
int limit = ...

auto lambda1 = [=](int value)    { return value > limit; }; // by-value
auto lambda2 = [&](int value)    { return value > limit; }; // by-reference
auto lambda3 = [limit](int value) { return value > limit; }; // "limit" by-value
auto lambda4 = [&limit](int value) { return value > limit; }; // "limit" by-reference
// auto lambda5 = [](int value)   { return value > limit; }; // no capture
//                               // compile error

int array[] = {7, 2, 5, 1};
std::find_if(array, array + 4, lambda1);
```

Capture List - Other Cases

- `[=, &var1]` captures all variables used in the body of the lambda **by-value**, except `var1` that is captured **by-reference**
- `[&, var1]` captures all variables used in the body of the lambda **by-reference**, except `var1` that is captured **by-value**
- A lambda expression can read a variable without capturing it if the variable is `constexpr`

```
constexpr int limit = 5;
int var1 = 3, var2 = 4;

auto lambda1 = [](int value){ return value > limit; };

auto lambda2 = [=, &var2]() { return var1 > var2;  };
```

Lambda Expression and Function Relation

A *lambda expression* can be converted to a function (*stateless*) if its capture list is empty

```
// lambda_func is equivalent to
// int lambda_func(int first, int second){ return first + second; };

void f(int (lambda_func)(int, int)) {
    cout << lambda_func(2, 3);
}

auto lambda = [](int first, int second){ return first + second; };
f(lambda); // print 5
```

C++14 Lambda expression parameters can be automatically deduced

```
auto x = [](auto value) { return value + 4; };
```

C++14 Lambda expression parameters can be initialized

```
auto x = [](int i = 6) { return i + 4; };
```

Lambda expressions can be composed

```
auto lambda1 = [](int value){ return value + 4; };
auto lambda2 = [](int value){ return value * 2; };

auto lambda3 = [&](int value){ return lambda2(lambda1(value)); };
// returns (value + 4) * 2
```

A function can return a lambda

(dynamic dispatch is also possible if the capture list is empty)

```
auto f() {
    return [](int value){ return value + 4; };
}
auto lambda = f();
cout << lambda(2); // print "6"
```

A lambda expression can contain another lambda expression

```
auto lambda1 = [](auto value) {  
    int x      = 5;  
    auto lambda2 = [=](auto v) { return x * value + v; };  
    return lambda2(3);  
};  
cout << lambda1(2); // print "13"
```

Lambda expressions can be called recursively

```
auto factorial = [](int n, auto fac) {  
    return (n <= 1) ? 1 : n * fac(n - 1, fac);  
};  
factorial(5, factorial);
```

C++23 allows to access the `this` pointer of a lambda object with the syntax `this auto` as first parameter

```
auto factorial = [](this auto self, int n) -> int { // or 'this auto&&'  
    return (n <= 1) ? 1 : n * self(n - 1);  
};  
factorial(5);
```

constexpr/constexpr Lambda Expression

C++17 Lambda expressions support `constexpr`

C++20 Lambda expressions support `constexpr`

```
// constexpr lambda  
auto factorial = [](int value) constexpr {  
    int ret = 1;  
    for (int i = 2; i <= value; i++)  
        ret *= i;  
    return ret;  
};  
auto mul = [](int v) constexpr { return v * 2; };  
  
constexpr int v1 = factorial(4) + mul(5); // '24' + '10'
```

C++20 Lambda expression supports `template` and `requires` clause

```
auto lambda = []<typename T>(T value)
    requires std::is_arithmetic_v<T> {
    return value * 2;
};
auto v = lambda(3.4); // v: 6.8 (double)
// lambda(nullptr); // compiler error
```

Before C++20, `template` arguments can be emulated with `auto` + `decltype`

```
auto lambda = [](auto value) {  
    using T = decltype(value); // T: double  
};  
lambda(3.4);
```

Lambda and template without automatic deduction needs the full syntax

```
auto lambda = []<typename T>(int value) {  
    return value * sizeof(T);  
};  
  
// lambda<double>(3); // compiler error  
lambda.operator()<double>(3); // ok
```

mutable Lambda Expression

Lambda capture is *by-const-value*

`mutable` specifier allows the lambda to modify the parameters captured *by-value*

```
int var = 1;

auto lambda1 = [&]() { var = 4; };           // ok
lambda1();
cout << var; // print '4'

// auto lambda2 = [=]() { var = 3; };      // compile error
// lambda operator() is const

auto lambda3 = [=]() mutable { var = 3; }; // ok
lambda3();
cout << var; // print '4', lambda3 captures by-value
```

Capture List and Classes ~>

- `[this]` captures the current object `(*this)` *by-reference* (implicit in C++17)
- `[x = x]` captures the current object member `x` *by-value* C++14
- `[&x = x]` captures the current object member `x` *by-reference* C++14
- `[=]` default capture of `this` pointer by value has been deprecated C++20

```
class A {
    int data = 1;

    void f() {
        int var = 2; // <-- local variable
        auto lambda1 = [=]() { return var; }; // copy by-value, return 2
        auto lambda2 = [=]() { int var = 3; return var; }; // return 3 (nearest scope)
        auto lambda3 = [this]() { return data; }; // copy by-reference, return 1
        auto lambda4 = [*this]() { return data; }; // copy by-value (C++17), return 1
        // auto lambda5 = [data]() { return data; }; // compile error 'data' is not visible
        auto lambda6 = [data = data]() { return data; }; // return 1
    }
};
```

Preprocessing

Preprocessing and Macro

A **preprocessor directive** is any line preceded by a *hash* symbol (#) which tells the compiler how to interpret the source code before compiling it

Macro are preprocessor directives which substitute any occurrence of an *identifier* in the rest of the code by replacement

Macro are evil:

Do not use macro expansion!!

...or use as little as possible

- Macro cannot be directly debugged
- Macro expansions can have unexpected side effects
- Macro have no namespace or scope

All statements starting with

- `#include "my_file.h"`

Inject the code in the current file

- `#define MACRO <expression>`

Define a new macro

- `#undef MACRO`

Undefine a macro

(a macro should be undefined as early as possible for safety reasons)

Multi-line Preprocessing: `\` at the end of the line

Indent: `# define`

Conditional Compiling

- `#if <condition>`

`code`

`#elif <condition>`

`code`

`#else`

`code`

`#endif`

- `#if defined(MACRO)` equal to `#ifdef MACRO`
`#elif defined(MACRO)` equal to `#elifdef MACRO` C++23

Check if a macro is defined

- `#if !defined(MACRO)` equal to `#ifndef MACRO`
`#elif !defined(MACRO)` equal to `#elifndef MACRO` C++23

Check if a macro is not defined

Common Error 1

A Define macros in header files and before includes!!

```
#include <iostream>

#define value // very dangerous!!
#include "big_lib.hpp"

int main() {
    std::cout << f(4); // should print 7, but it always prints 3
}
```

big_lib.hpp:

```
int f(int value) { // 'value' disappears
    return value + 3;
}
```

It is very hard to see this problem when the macro is in a header

Common Error 2

`#if defined` can introduce bugs related to macro visibility

```
// #include "macro_definition.hpp" // forget to add the header that defines ENABLE_DEBUG
```

```
#if defined(ENABLE_DEBUG)
```

```
    void f(int v) { cout << v << endl; return v * 3; }
```

```
#else
```

```
    void f(int v) { return v * 3; }
```

```
#endif
```

```
#if ENABLE_DEBUG // evaluated to 0 or 1
```

```
    void f(int v) { cout << v << endl; return v * 3; }
```

```
#else
```

```
    void f(int v) { return v * 3; }
```

```
#endif
```

Forget to use parenthesis in macro definitions!!

```
#include <iostream>

#define SUB1(a, b) a - b           // WRONG
#define SUB2(a, b) (a - b)        // WRONG
#define SUB3(a, b) ((a) - (b))    // correct

int main() {
    std::cout << (5 * SUB1(2, 1)); // print 9 not 5!!
    std::cout << SUB2(3 + 3, 2 + 2); // print 6 not 2!!
    std::cout << SUB3(3 + 3, 2 + 2); // print 2
}
```

Macros make hard to find compile errors!!

```
1: #include <iostream>
2:
3: #define F(a) {      \
4:     ...             \
5:     ...             \
6:     return v;
7:
8: int main() {
9:     F(3);    // compile error at line 9!!
10: }
```

- In which line is the error??!*

*modern compilers are able to roll out the macro

Common Error 5

Macro can introduce bugs related to the evaluation of their expressions!!

```
#if defined(DEBUG)
#   define CHECK(EXPR)    // do something with EXPR
    void check(bool b) { /* do something with b */ }
#else
#   define CHECK(EXPR)    // do nothing
    void check(bool) {}  // do nothing
#endif
bool f() { /* return a boolean value */ }

check( f() )
CHECK( f() ) // <-- problem here
```

- What happens when `DEBUG` is not defined?

`f()` is not evaluated by using the macro

Forget curly brackets in multi-lines macros!!

```
#include <iostream>
#include <nuclear_explosion.hpp>

#define NUCLEAR_EXPLOSION          \ // {
    std::cout << "start nuclear explosion"; \
    nuclear_explosion();
                                     // }

int main() {
    bool never_happen = false;
    if (never_happen)
        NUCLEAR_EXPLOSION
} // BOOM!! 💀
```

The second line is executed!!

Macros do not have scope!!

```
#include <iostream>

void f() {
    #define value 4
    std::cout << value;
}

int main() {
    f();                // 4
    std::cout << value; // 4
    #define value 3
    f();                // 4
    std::cout << value; // 3
}
```

* In general, compilers raise a warning for multiple definitions of the same macro

Macros can have side effect!!

```
#define MIN(a, b) ((a) < (b) ? (a) : (b))

int main() {
    int array1[] = { 1, 5, 2 };
    int array2[] = { 6, 3, 4 };
    int i = 0;
    int j = 0;
    int v1 = MIN(array1[i++], array2[j++]); // v1 = 5!!
    int v2 = MIN(array1[i++], array2[j++]); // undefined behavior/
}                                           // segmentation fault ☠
```

Macros can have undefined behavior themselves!!

```
#define MY_MACRO defined(EXTERNAL_MACRO)

#if MY_MACRO
#   define MY_VALUE 1
#else
#   define MY_VALUE 0
#endif

int f() { return MY_VALUE; } // undefined behavior
```

When Preprocessors are Necessary

- **Conditional compiling:** different architectures, compiler features, etc.
- **Mixing different languages:** code generation (example: asm assembly)
- **Complex name replacing:** see template programming

Otherwise, prefer `const` and `constexpr` for constant values and functions

```
#define SIZE 3 // replaced with  
const int SIZE = 3; // only C++11 at global scope  
  
#define SUB(a, b) ((a) - (b)) // replaced with  
constexpr int sub(int a, int b) {  
    return a - b;  
}
```

`__LINE__` Integer value representing the current line in the source code file being compiled

`__FILE__` A string literal containing the name of the source file being compiled

`__FUNCTION__` (non-standard, gcc, clang) A string literal containing the name of the function in the 'macro scope'

`__PRETTY_FUNCTION__` (non-standard, gcc, clang) A string literal containing the full signature of the function in the 'macro scope'

`__func__` (C++11 keyword) A string containing the name of the function in the 'macro scope'

source.cpp:

```
#include <iostream>

void f(int p) {
    std::cout << __FILE__ << ":" << __LINE__; // print 'source.cpp:4'
    std::cout << __FUNCTION__; // print 'f'
    std::cout << __func__; // print 'f'
}

// see template lectures
template<typename T>
float g(T p) {
    std::cout << __PRETTY_FUNCTION__; // print 'float g(T) [T = int]'
    return 0.0f;
}

void g1() { g(3); }
```

C++20 provides source location utilities for replacing macro-based approach

```
#include <source_location>
```

```
current() get source location info (static member)
```

```
line() source code line
```

```
column() line column
```

```
file_name() current file name
```

```
function_name() current function name
```

```
#include <source_location>
```

```
void f(std::source_location s = std::source_location::current()) {  
    cout << "function: " << s.function_name() << ", line " << s.line();  
}
```

```
}
```

```
f(); // print: "function: f, line 6"
```

Select code depending on the C/C++ version

- `#if defined(__cplusplus)` C++ code
- `#if __cplusplus == 199711L` ISO C++ 1998/2003
- `#if __cplusplus == 201103L` ISO C++ 2011*
- `#if __cplusplus == 201402L` ISO C++ 2014*
- `#if __cplusplus == 201703L` ISO C++ 2017

Select code depending on the compiler

- `#if defined(__GNUC__)` The compiler is gcc/g++ †
- `#if defined(__clang__)` The compiler is clang/clang++
- `#if defined(_MSC_VER)` The compiler is Microsoft Visual C++

* MSVC defines `__cplusplus == 199711L` even for C++11/14

† `__GNUC__` is defined by many compilers, e.g clang

Select code depending on the operating system or environment

- `#if defined(_WIN64)` OS is Windows 64-bit
- `#if defined(__linux__)` OS is Linux
- `#if defined(__APPLE__)` OS is Mac OS
- `#if defined(__MINGW32__)` OS is MinGW 32-bit
- ...and many others

`__DATE__` A string literal in the form "MMM DD YYYY" containing the date in which the compilation process began

`__TIME__` A string literal in the form "hh:mm:ss" containing the time at which the compilation process began

Very comprehensive macro list:

- sourceforge.net/p/predef/wiki/Home/
- How to detect the operating system type using compiler predefined macros
- Abseil platform macros
- Boost.Predef

Feature Testing Macro

C++17 introduces `__has_include` macro which returns `1` if header or source file with the specified name exists

```
#if __has_include(<iostream>)  
# include <iostream>  
#endif
```

C++20 introduces a set of macros to evaluate if a given feature is supported by the compiler

```
#if __cpp_constexpr  
constexpr int square(int x) { return x * x; }  
#endif
```

Macros depend on compilers and environment!!

```
struct A {  
    int x; // enable C++11 code  
#if __cplusplus >= 201103  
    A() = default;  
#else  
    A() {}  
#endif  
};  
  
// should return ≈ 10.0f  
float safe_function() {  
    A a{}; // zero-initialization  
    for (int i = 0; i < 10; i++)  
        a.x += 1.0f;  
    return a.x;  
}  
// what is the behavior ???
```

The code works fine on Linux, but not under Windows MSVC. MSVC sets `__cplusplus` to `199711` even if C++11/14/17 flag is set!! in this case the code can return `NaN`

see Lecture “Object-Oriented Programming II - Zero Initialization” and MSVC now correctly reports `__cplusplus`

Stringizing Operator (#)

The **stringizing macro operator** (**#**) causes the corresponding actual argument to be enclosed in double quotation marks **"**

```
#define STRING_MACRO(string) #string
```

```
cout << STRING_MACRO(hello); // equivalent to "hello"
```

```
#define INFO_MACRO(my_func) \
{\
    my_func \
    cout << "call " << #my_func << " at " \
        << __FILE__ << ":" << __LINE__;\
}
```

```
void g(int) {}
```

```
INFO_MACRO( g(3) ) // print: "call g(3) at my_file.cpp:7"
```

Code injection

```
#include <stdio>

#define CHECK_ERROR(condition) \
{ \
    if (condition) { \
        std::printf("expr: " #condition " failed at line %d\n", \
                    __LINE__); \
    } \
}

int t = 6, s = 3;
CHECK_ERROR(t > s) // print "expr: t > s failed at line 13"
CHECK_ERROR(t % s == 0) // segmentation fault!!! ☠️
// printf interprets "% s" as a format specifier
```

#error and #warning

- `#error "text"` The directive emits a user-specified error message at compile time when the compiler parse it and stop the compilation process
- `C++23 #warning "text"` The directive emits a user-specified warning message at compile time when the compiler parse it without stopping the compilation process

#pragma

The `#pragma` directive controls implementation-specific behavior of the compiler. In general, it is not portable

- `#pragma message "text"` Display informational messages at compile time (every time this instruction is parsed)
- `#pragma GCC diagnostic warning "-Wformat"`
Disable a GCC warning
- `_Pragma(<command>)` (C++11)

It is a keyword and can be embedded in a `#define`

```
#define MY_MESSAGE \  
    _Pragma("message(\"hello\")")
```

Token-Pasting Operator (##) ★

The **token-concatenation (or pasting) macro operator** (`##`) allows combining two tokens (without leaving no blank spaces)

```
#define FUNC_GEN_A(tokenA, tokenB) \  
    void tokenA##tokenB() {}
```

```
#define FUNC_GEN_B(tokenA, tokenB) \  
    void tokenA##_##tokenB() {}
```

```
FUNC_GEN_A(my, function)
```

```
FUNC_GEN_B(my, function)
```

```
myfunction(); // ok, from FUNC_GEN_A
```

```
my_function(); // ok, from FUNC_GEN_B
```

Variadic Macro ★

A **variadic macro C++11** is a special macro accepting a variable number of arguments (separated by comma)

Each occurrence of the special identifier `__VA_ARGS__` in the macro replacement list is replaced by the passed arguments

Example:

```
void f(int a)           { printf("%d", a);           }
void f(int a, int b)    { printf("%d %d", a, b);     }
void f(int a, int b, int c) { printf("%d %d %d", a, b, c); }
```

```
#define PRINT(...) \  
    f(__VA_ARGS__);
```

```
PRINT(1, 2)
```

```
PRINT(1, 2, 3)
```

Convert a number literal to a string literal

```
#define TO_LITERAL_AUX(x) #x  
#define TO_LITERAL(x) TO_LITERAL_AUX(x)
```

Motivation: avoid integer to string conversion (performance)

```
int main() {  
    int x1 = 3 * 10;  
    int y1 = __LINE__ + 4;  
    char x2[] = TO_LITERAL(3);  
    char y2[] = TO_LITERAL(__LINE__);  
}
```

Modern C++ Programming

7. OBJECT-ORIENTED PROGRAMMING I

CLASS CONCEPTS

Federico Busato

2024-11-05

1 C++ Classes

- RAII Idiom

2 Class Hierarchy

3 Access specifiers

- Inheritance Access Specifiers
- When Use `public/protected/private/` for Data Members?

4 Class Constructor

- Default Constructor
- Class Initialization
- Uniform Initialization for Objects
- Delegate Constructor
- `explicit` Keyword
- `[[nodiscard]]` and Classes

5 Copy Constructor

6 Class Destructor

7 Defaulted Constructors, Destructor, and Operators
(=default)

8 Class Keywords

- `this`
- `static`
- `const`
- `mutable`
- `using`
- `friend`
- `delete`

C++ Classes

C Structure

A **C structure** (`struct`) is a collection of variables of the same or different data types under a single name

C++ Class

A **class** (`class`) extends the concept of structure to hold functions as members

struct vs. class in C++

Structures and *classes* are *semantically* equivalent in **C++**. However, the keywords should be used to distinguish between different semantics:

- `struct` represents *passive* objects, namely the *physical state* (set of data)
- `class` represents *active* objects, namely the *logical state* (data abstraction)

Class Members - Data and Function Members

Data Member

Data within a class are called **data members** or **class fields**

Function Member

Functions within a class are called **function members** or **methods**

Holding a resource is a class invariant, and is tied to object lifetime

RAII Idiom consists in three steps:

- Encapsulate a resource into a class (*constructor*)
- Use the resource via a local instance of the class
- The resource is automatically released when the object gets out of scope (*destructor*)

Implication 1: C++ programming language does not require the garbage collector!!

Implication 2 :The programmer has the responsibility to manage the resources

struct/class Declaration and Definition

struct declaration and definition

```
struct A;           // struct declaration

struct A {         // struct definition
    int x;         // data member
    void f();     // function member
};
```

class declaration and definition

```
class A;           // class declaration

class A {         // class definition
    int x;         // data member
    void f();     // function member
};
```

struct/class Function Declaration and Definition

```
struct A {  
    void g();           // function member declaration  
  
    void f() {         // function member declaration  
        cout << "f"; // inline definition  
    }  
};  
  
void A::g() {         // function member definition  
    cout << "g";     // out-of-line definition  
}
```

struct/class Members

```
struct B {  
    void g() { cout << "g"; } // function member  
};  
  
struct A {  
    int x; // data member  
    B b; // data member  
    void f() { cout << "f"; } // function member  
};  
  
A a;  
a.x;  
a.f();  
a.b.g();
```

Class Hierarchy

Child/Derived Class or Subclass

A new class that inheriting variables and functions from another class is called a **derived** or **child** class

Parent/Base Class

The *closest* class providing variables and functions of a derived class is called **parent** or **base** class

Extend a *base class* refers to creating a new class which retains characteristics of the base class and *on top it can add* (and never remove) its own members

Syntax:

```
class DerivedClass : [<inheritance attribute>] BaseClass {
```

```
struct A {           // base class
    int value = 3;

    void g() {}
};

struct B : A {       // B is a derived class of A (B extends A)
    int data = 4;    // B inherits from A

    int f() { return data; }
};

A a;
B b;
a.value;
b.g();
```

```
struct A {};  
struct B : A {};  
  
void f(A a) {}      // copy  
void g(B b) {}      // copy  
  
void f_ref(A& a) {} // the same for A*  
void g_ref(B& b) {} // the same for B*  
  
A a;  
B b;  
f(a); // ok, also f(b), f_ref(a), g_ref(b)  
g(b); // ok, also g_ref(b), but not g(a), g_ref(a)  
  
A a1 = b;    // ok, also A& a2 = b  
// B b1 = a; // compile error
```

Access specifiers

The **access specifiers** define the visibility of inherited members of the subsequent base class. The keywords `public`, `private`, and `protected` specify the sections of visibility

The goal of the *access specifiers* is to prevent direct access to the internal representation of the class for avoiding wrong usage and potential inconsistency (access control)

- **public**: No restriction (*function members, derived classes, outside the class*)
- **protected**: *Function members and derived classes access*
- **private**: *Function members only access (internal)*

`struct` has default `public` members

`class` has default `private` members

```
struct A1 {
    int value;    // public (by default)
protected:
    void f1() {} // protected
private:
    void f2() {} // private
};

class A2 {
    int data;    // private (by default)
};

struct B : A1 {
    void h1() { f1(); } // ok, "f1" is visible in B
    // void h2() { f2(); } // compile error "f2" is private in A1
};

A1 a;
a.value; // ok
// a.f1() // compile error protected
// a.f2() // compile error private
```

The **access specifiers** are also used for defining how the visibility is propagated from the *base class* to a *specific derived class* in the inheritance

| Member declaration | | Inheritance | | Derived classes |
|--------------------------------|---|-------------|---|---|
| public protected private | → | public | → | public protected \ protected protected \ private private \ private |
| public protected private | → | protected | → | protected protected \ private private \ private |
| public protected private | → | private | → | private private \ private |

```
struct A {
    int var1; // public
protected:
    int var2; // protected
};

struct B : protected A {
    int var3; // public
};

B b;
// b.var1; // compile error, var1 is protected in B
// b.var2; // compile error, var2 is protected in B
b.var3;    // ok, var3 is public in B
```

```
class A {
public:
    int var1;
protected:
    int var2;
};

class B1 : A {};           // private inheritance

class B2 : public A {};  // public inheritance

B1 b1;
// b1.var1; // compile error, var1 is private in B1
// b1.var2; // compile error, var2 is private in B1

B2 b2;
b2.var1;    // ok, var1 is public in B2
```

When Use `public/protected/private/` for Data Members?

When use `protected/private` data members:

- They are not part of the interface, namely the *logical state* of the object (not useful for the user)
- They must preserve the `const` correctness (e.g. for pointer), see Advanced Concepts I

When use `public` data members:

- They can potentially change any time
- `const` correctness is preserved for values and references, as opposite to pointers. *Data members* should be preferred to *member functions* in this case

Class Constructor

Constructor [ctor]

A **constructor** is a *special* member function of a class that is executed when a new instance of that class is created

Goals: *initialization* and *resource acquisition*

Syntax: `T(...)` same named of the class and no return type

- A *constructor* is supposed to initialize all data members
- We can define *multiple constructors* with different signatures
- Any *constructor* can be `constexpr`

Default Constructor

Default Constructor

The **default constructor** `T()` is a constructor with no argument

Every class has always either an *implicit*, *explicit*, or *deleted* default constructor

```
struct A {  
    A() {} // explicit default constructor  
    A(int) {} // user-defined (non-default) constructor  
};
```

```
struct A {  
    int x = 3; // implicit default constructor  
};  
A a{}; // call the default constructor, equivalent to: A a;
```

Note: an *implicit* default constructor is `constexpr`

Default Constructor Examples

```
struct A {  
    A() { cout << "A"; } // default constructor  
};  
  
A a1;           // call the default constructor  
// A a2();     // interpreted as a function declaration!!  
A a3{};        // ok, call the default constructor  
               // direct-list initialization (C++11)  
  
A array[3];    // print "AAA"  
  
A* ptr = new A[4]; // print "AAAA"
```

The *implicit* default constructor of a class is marked as **deleted** if (simplified):

- It has any user-defined constructor

```
struct A {  
    A(int x) {}  
};  
  
// A a; // compile error
```

- It has a non-static member/base class of reference/const type

```
struct NoDefault { // deleted default constructor  
    int& x;  
    const int y;  
};
```

- It has a non-static member/base class which has a deleted (or inaccessible) default constructor

```
struct A {  
    NoDefault var;      // deleted default constructor  
};  
struct B : NoDefault {}; // deleted default constructor
```

- It has a non-static member/base class with a deleted or inaccessible destructor

```
struct A {  
private:  
    ~A() {}  
};
```

Initializer List

The **Initializer list** is used for *initializing the data members* of a class or explicitly call the base class constructor before entering the constructor body

(Not to be confused with `std::initializer_list`)

```
struct A {  
    int x, y;  
  
    A(int x1) : x(x1) {} // ": x(x1)" is the Initializer list  
                // direct initialization syntax  
  
    A(int x1, int y1) : // ": x{x1}, y{y1}"  
        x{x1},        // is the Initializer list  
        y{y1} {}      // direct-list initialization syntax  
};                    // (C++11)
```

In-Class Member Initializer

C++11 In-class non-static data members initialization (NSDMI) allows initializing the data members where they are declared. A user-defined constructor can be used to override their default values

```
struct A {  
    int      x      = 0;          // in-class member initializer  
    const char* str = nullptr; // in-class member initializer  
  
    A() {} // "x" and "str" are well-defined if  
           // the default constructor is called  
  
    A(const char* str1) : str{str1} {}  
};
```

Data Member Initialization

const and **reference** data members must be initialized by using the *initialization list* or by using in-class *brace-or-equal-initializer* syntax (C++11)

```
struct A {  
    int      x;  
    const char y;    // must be initialized  
    int&     z;      // must be initialized  
  
    int&     v = x;  // equal-initializer (C++11)  
    const int w{4};  // brace initializer (C++11)  
  
    A() : x(3), y('a'), z(x) {}  
};
```

Initialization Order

Class member initialization follows the order of declarations and *not* the order in the initialization list

```
struct ArrayWrapper {
    int* array;
    int size;

    ArrayWrapper(int user_size) :
        size{user_size},
        array{new int[size]} {}
        // wrong!!: "size" is still undefined
};

ArrayWrapper a(10);
cout << a.array[4]; // segmentation fault
```

Uniform Initialization (C++11)

Uniform Initialization `{}`, also called *list-initialization*, is a way to fully initialize any object independently of its data type

- **Minimizing Redundant Typenames**
 - In function arguments
 - In function returns
- Solving the “**Most Vexing Parse**” problem
 - Constructor interpreted as function prototype

Minimizing Redundant Typenames

```
struct Point {  
    int x, y;  
    Point(int x1, int y1) : x(x1), y(y1) {}  
};
```

C++03

```
Point add(Point a, Point b) {  
    return Point(a.x + b.x, a.y + b.y);  
}  
Point c = add(Point(1, 2), Point(3, 4));
```

C++11

```
Point add(Point a, Point b) {  
    return { a.x + b.x, a.y + b.y }; // here  
}  
auto c = add({1, 2}, {3, 4}); // here
```

```
struct A {  
    A(int) {}  
};  
  
struct B {  
    // A a(1); // compile error It works in a function scope  
    A a{2}; // ok, call the constructor  
};
```



```
struct A {};  
  
struct B {  
    B(A a) {}  
    void f() {}  
};  
  
B b( A() ); // "b" is interpreted as function declaration  
           // with a single argument A (*)() (func. pointer)  
// b.f()   // compile error "Most Vexing Parse" problem  
           // solved with B b{ A{} };
```

Constructors and Inheritance

Class constructors are never inherited

A *Derived* class must call *implicitly* or *explicitly* a *Base* constructor before the current class constructor

Class constructors are called in order from the top Base class to the most Derived class (C++ objects are constructed like onions)

```
struct A {
    A() { cout << "A" };
};
struct B1 : A { // call "A()" implicitly
    int y = 3; // then, "y = 3"
};
struct B2 : A { // call "A()" explicitly
    B2() : A() { cout << "B"; }
};
B1 b1; // print "A"
B2 b2; // print "A", then print "B"
```

Delegate Constructor

The problem:

Most constructors usually perform identical initialization steps before executing individual operations

C++11 A **delegate constructor** calls another constructor of the same class to reduce the repetitive code by adding a function that does all the initialization steps

```
struct A {
    int a;
    float b;
    bool c;
    // standard constructor:
    A(int a1, float b1, bool c1) : a(a1), b(b1), c(c1) {
        // do a lot of work
    }

    A(int a1, float b1) : A(a1, b1, false) {} // delegate constructor
    A(float b1) : A(100, b1, false) {} // delegate constructor
};
```

explicit

The `explicit` keyword specifies that a *constructor* or *conversion operator* (C++11) does not allow implicit conversions or copy-initialization from single arguments or braced initializers

The problem:

```
struct MyString {
    MyString(int n);           // (1) allocates n bytes for the string
    MyString(const char *p); // (2) initializes starting from a raw string
};
MyString string = 'a';      // calls (1), implicit conversion!!
```

`explicit` cannot be applied to *copy/move-constructors*

```
struct A {  
    A() {}  
    A(int) {}  
    A(int, int) {}  
};  
void f(const A&) {}
```

```
A a1 = {};           // ok  
A a2(2);            // ok  
A a3 = 1;           // ok (implicit)  
A a4{4, 5};         // ok. Selected A(int, int)  
A a5 = {4, 5};     // ok. Selected A(int, int)  
f({});             // ok  
f(1);              // ok  
f({1});           // ok
```

```
struct B {  
    explicit B() {}  
    explicit B(int) {}  
    explicit B(int, int) {}  
};  
void f(const B&) {}
```

```
// B b1 = {};       // error implicit conversion  
B b2(2);           // ok  
// B b3 = 1;       // error implicit conversion  
B b4{4, 5};        // ok. Selected B(int, int)  
// B b5 = {4, 5};  // error implicit conversion  
B b6 = (B) 1;      // OK: explicit cast  
// f({});          // error implicit conversion  
// f(1);           // error implicit conversion  
// f({1});         // error implicit conversion  
f(B{1});           // ok
```

[[nodiscard]] and Classes

C++17 allows setting `[[nodiscard]]` for the entire `class/struct`

```
[[nodiscard]] struct A {};  
A f() { return A{}; }  
  
auto x = f(); // ok  
f();         // compiler warning
```

C++20 allows to set `[[nodiscard]]` for constructors

```
struct A {  
    [[nodiscard]] A() {} // C++20 also allows [[nodiscard]] with a reason  
};  
void f(A {})  
  
A a{}; // ok  
f(A{}); // ok  
A{};   // compiler warning
```

Copy Constructor

Copy Constructor

A **copy constructor** `T(const T&)` creates a new object as a *deep copy* of an existing object

```
struct A {  
    A()          {} // default constructor  
    A(int)       {} // non-default constructor  
    A(const A&) {} // copy constructor → direct initialization  
}
```

Copy Constructor Details

- Every class always defines an *implicit* or *explicit* copy constructor, potentially *deleted*
- The copy constructor implicitly calls the *default* Base class constructor
- Even the copy constructor is considered a *user-defined* constructor
- The copy constructor doesn't have template parameters, otherwise it is a standard member function
- The copy constructor must not be confused with the assignment operator

`operator=`

```
MyStruct x;  
MyStruct y{x}; // copy constructor  
y = x;        // call the assignment operator=, not the copy constructor  
              // → copy initialization, see next lecture
```

Copy Constructor Example

```
struct Array {
    int size;
    int* array;

    Array(int size1) : size{size1} {
        array = new int[size];
    }
    // copy constructor, ": size{obj.size}" initializer list
    Array(const Array& obj) : size{obj.size} {
        array = new int[size];
        for (int i = 0; i < size; i++)
            array[i] = obj.array[i];
    }
};

Array x{100}; // do something with x.array ...
Array y{x};  // call "Array::Array(const Array&)"
```

Copy Constructor Usage

The copy constructor is used to:

- Initialize one object from another one having the same type
 - Direct constructor
 - Assignment operator

```
A a1;  
A a2(a1);    // Direct copy initialization  
A a3{a1};    // Direct copy initialization  
A a4 = a1;   // Copy initialization  
A a5 = {a1}; // Copy list initialization
```

- Copy an object which is *passed by-value* as input parameter of a function

```
void f(A a);
```

- Copy an object which is returned as result from a function*

```
A f() { return A(3); } // * see RVO optimization
```

Copy Constructor Usage Examples

```
struct A {  
    A() {}  
    A(const A& obj) { cout << "copy"; }  
};  
  
void f(A a) {} // pass by-value  
  
A g1(A& a) { return a; }  
  
A g2()      { return A(); }  
  
A a;  
A b = a;    // copy constructor (assignment) "copy"  
A c(b);     // copy constructor (direct)    "copy"  
f(b);      // copy constructor (argument)  "copy"  
g1(a);     // copy constructor (return value) "copy"  
A d = g2(); // * see RVO optimization (Advanced Concepts I)
```

Pass by-value and Copy Constructor

```
struct A {  
    A() {}  
    A(const A& obj) { cout << "expensive copy"; }  
};  
  
struct B : A {  
    B() {}  
    B(const B& obj) { cout << "cheap copy"; }  
};  
  
void f1(B b) {}  
void f2(A a) {}  
  
B b1;  
f1(b1); // cheap copy  
f2(b1); // expensive copy!! It calls A(const A&) implicitly
```

Deleted Copy Constructor

The *implicit* copy constructor of a class is marked as **deleted** if (simplified):

- It has a non-static member/base class of reference/const type

```
struct NonDefault { int& x; }; // deleted copy constructor
```

- It has a non-static member/base class which has a deleted (or inaccessible) copy constructor

```
struct B { // deleted copy constructor
    NonDefault a;
};
struct B : NonDefault {}; // delete copy constructor
```

- It has a non-static member/base class with a deleted or inaccessible destructor
- The class has the move constructor (next lectures)

Class Destructor

Destructor [dtor]

A **destructor** is a special member function that is executed whenever an object is out-of-scope or whenever the `delete/delete[]` expression is applied to a pointer of that class

Goals: *resources releasing*

Syntax: `~T()` same name of the class and no return type

- Any object has exactly one *destructor*, which is always *implicitly* or *explicitly* declared
- **C++20** The *destructor* can be `constexpr`

```
struct Array {  
    int* array;  
  
    Array() { // constructor  
        array = new int[10];  
    }  
  
    ~Array() { // destructor  
        delete[] array;  
    }  
};  
  
int main() {  
    Array a; // call the constructor  
    for (int i = 0; i < 5; i++)  
        Array b; // call 5 times the constructor + destructor  
} // call the destructor of "a"
```

Class destructor is never inherited. *Base* class destructor is invoked *after* the current class destructor

Class destructors are called in reverse order. From the most Derived to the top Base class

```
struct A {
    ~A() { cout << "A"; }
};
struct B {
    ~B() { cout << "B"; }
};
struct C : A {
    B b;           // call ~B()
    ~C() { cout << "C"; }
};
int main() {
    C b; // print "C", then "B", then "A"
}
```

**Defaulted
Constructors,
Destructor, and
Operators
(=default)**

C++11 The compiler can automatically generate

- **default/copy/move constructors**

 - `A() = default`

 - `A(const A&) = default`

 - `A(A&&) = default`

- **destructor**

 - `~A() = default`

- **copy/move assignment operators** `A& operator=(const A&) = default`

 - `A& operator=(A&&) = default`

- **spaceship operator**

 - `auto operator<=>(const A&) const = default`

`= default` implies `constexpr`, but not `noexcept` or `explicit`

When the compiler-generated constructors, destructors, and operators are useful:

- Change the visibility of non-user provided constructors and assignment operators (`public`, `protected`, `private`)
 - Make visible the declarations of such members
-

The **defaulted** default constructor has a similar effect as a user-defined constructor with empty body and empty initializer list

When the compiler-generated constructor is useful:

- Any user-provided constructor disables implicitly-generated default constructor
- Force the default values for the class data members

```
struct A {  
    A(int v1) {}    // delete implicitly-defined default ctor because  
                  // a user-provided constructor is defined  
  
    A() = default; // now, A has the default constructor  
};
```

```
struct B {  
protected:  
    B() = default; // now it is protected  
};
```

```
struct C {  
    int x;  
    // C() {}    // 'x' is undefined  
    C() = default; // 'x' is zero  
};
```

Class Keywords

this Keyword

`this`

Every object has access to its own address through the pointer `this`

Explicit usage is not mandatory (and not suggested)

`this` is necessary when:

- The name of a local variable is equal to some member name
- Return reference to the calling object

```
struct A {  
    int x;  
    void f(int x) {  
        this->x = x; // without "this" has no effect  
    }  
    const A& g() {  
        return *this;  
    }  
};
```

static Keyword

The keyword `static` declares members (fields or methods) that are not bound to class instances. A **static** member is shared by all objects of the class

```
struct A {  
    int x;  
  
    int f() { return x; }  
  
    static int g() { return 3; } // g() cannot access 'x' as it is associated  
};                               // with class instances  
A a{4};  
a.f(); // call the class instance method  
A::g(); // call the static class method  
a.g(); // as an alternative, a class instance can access static class members
```

```
struct A {  
    static const int      a = 4;           // C++03  
    static constexpr float b = 4.2f;     // better, C++11  
    // static const float  c = 4.2f;     // only GNU extension (GCC)  
  
    static constexpr int f() { return 1; } // ok, C++11  
    // static const int    g() { return 1; } // 'const' refers to the return type  
};
```

Non-`const` `static` data members cannot be *directly* initialized inline (see Translation Units lecture)...before C++17

```
struct A {  
    // static int      a = 4; // compiler error  
    static int      a;      // ok, declaration only  
    static inline int b = 4; // ok from C++17  
  
    static int f() { return 2; }  
    static int g();        // ok, declaration only  
};  
  
int A::a = 4;              // ok, undefined reference without this definition  
int A::g() { return 3; }  // ok, undefined reference without this definition
```

```
struct A {  
    static int x; // declaration  
  
    static int f() { return x; }  
  
    static int& g() { return x; }  
};  
int A::x = 3; // definition  
  
//-----  
  
A::f();    // return 3  
A::x++;  
A::f();    // return 4  
A::g() = 7;  
A::f();    // return 7
```

- A `static` member function can only access `static` class members
- A non-`static` member function can access `static` class members

```
struct A {  
    int          x = 3;  
    static inline int y = 4;  
  
    int          f1() { return x; } // ok  
// static int f2() { return x; } // compiler error, 'x' is not visible  
    int          g1() { return y; } // ok  
    static int g2() { return y; } // ok  
  
    struct B {  
        int h() { return y + g2(); } // ok  
}; // 'x', 'f1()', 'g1()' are not visible within 'B'  
};
```

Const member functions

Const member functions (**inspectors** or **observers**) are functions marked with `const` that are not allowed to change the object logical state

The compiler prevents from inadvertently mutating/changing the data members of *observer* functions → All data members are marked `const` within an **observer** method, including the `this` pointer

- The *physical state* can still be modified, see `mutable` member functions ↔
- Member functions without a `const` suffix are called *non-const member functions* or **mutators/modifiers**

```
struct A {  
    int x = 3;  
    int* p;  
  
    int get() const {  
        // x = 2;           // compile error class variables cannot be modified  
        // p = nullptr;    // compile error class variables cannot be modified  
        p[0] = 3;         // ok, p is 'int* const' -> its content is  
                          // not protected  
        return x;  
    }  
};
```

A common case where `const` member functions are useful is to enforce const correctness when accessing pointers, see [Advanced Concepts I, Const Correctness](#)

The `const` keyword is part of the function signature. Therefore, a class can implement two similar methods, one which is called when the object is `const`, and one that is not

```
class A {
    int x = 3;
public:
    int& get1()      { return x; } // read and write
    int  get1() const { return x; } // read only
    int& get2()      { return x; } // read and write
};

A a1;
cout << a1.get1();    // ok
cout << a1.get2();    // ok
a1.get1() = 4;       // ok
const A a2;
cout << a2.get1();    // ok
// cout << a2.get2(); // compile error "a2" is const
//a2.get1() = 5;     // compile error only "get1() const" is available
```

mutable

`mutable` data members of *const* class instances are modifiable. They should be part of the object *physical state*, but not of the *logical state*

- It is particularly useful if most of the members should be constant but a few need to be modified
- Conceptually, `mutable` members should not change anything that can be retrieved from the class interface

```
struct A {  
    int      x = 3;  
    mutable int y = 5;  
};  
const A a;  
// a.x = 3; // compiler error const  
a.y = 5;    // ok
```

using Keyword for type declaration

The `using` keyword is used to declare a *type alias* tied to a specific class

```
struct A {  
    using type = int;  
};  
  
typename A::type x = 3; // "typename" keyword is needed when we refer to types  
  
struct B : A {};  
  
typename B::type x = 4; // B can use "type" as it is public in A
```

using Keyword for Inheritance

The `using` keyword can be also used to change the *inheritance attribute* of member data or functions

```
struct A {  
    protected:  
        int x = 3;  
};  
  
struct B : A {  
    public:  
        using A::x;  
};  
  
B b;  
b.x = 3; // ok, "b.x" is public
```

friend Class

A `friend` class can access the private and protected members of the class in which it is declared as a friend

Friendship properties:

- **Not Symmetric:** if class `A` is a friend of class `B`, class `B` is not automatically a friend of class `A`
- **Not Transitive:** if class `A` is a friend of class `B`, and class `B` is a friend of class `C`, class `A` is not automatically a friend of class `C`
- **Not Inherited:** if class `Base` is a friend of class `X`, subclass `Derived` is not automatically a friend of class `X`; and if class `X` is a friend of class `Base`, class `X` is not automatically a friend of subclass `Derived`

```
class B;    // class declaration

class A {
    friend class B;
    int x;    // private
};

class B {
    int f(A a) { return a.x; } // ok, B is friend of A
};

class C : B {
    // int f(A a) { return a.x; } // compile error not inherited
};
```

friend Method

A *non-member function* can access the private and protected members of a class if it is declared a **friend** of that class

```
class A {  
    int x = 3; // private  
  
    friend int f(A a); // friendship declaration, no implementation  
};  
  
// 'f' is not a member function of any class  
int f(A a) {  
    return a.x; // A is friend of f(A)  
}
```

friend methods are commonly used for implementing the stream operator **operator<<**

delete Keyword

delete Keyword (C++11)

The `delete` keyword explicitly marks a member function as deleted and any use results in a compiler error. When it is applied to *copy/move constructor* or *assignment*, it prevents the compiler from implicitly generating these functions

The default copy/move functions for a class can produce unexpected results. The keyword `delete` prevents these errors

```
struct A {
    A()          = default;
    A(const A&) = delete; // e.g. deleted because unsafe or expensive
};

void f(A a) {} // implicit call to copy constructor

A a;
// f(a);      // compile error marked as deleted
```

Modern C++ Programming

8. OBJECT-ORIENTED PROGRAMMING II

POLYMORPHISM AND OPERATOR OVERLOADING

Federico Busato

2024-11-05

1 Polymorphism

- C++ Mechanisms for Polymorphism
- `virtual` Methods
- Virtual Table
- `override` Keyword
- `final` Keyword
- Common Errors
- Pure Virtual Method
- Abstract Class and Interface

2 Inheritance Casting and Run-time Type Identification ★

3 Operator Overloading

- Overview
- Comparison Operator `operator<`
- Spaceship Operator `operator<=>`
- Subscript Operator `operator[]`
- Multidimensional Subscript Operator `operator[][]`
- Function Call Operator `operator()`
- `static operator()` and `static operator[]`
- Conversion Operator `operator T()`
- Return Type Overloading Resolution ★

Table of Contents

- Increment and Decrement Operators `operator++/--`
- Assignment Operator `operator type=`
- Stream Operator `operator<<`
- Operator Notes

4 C++ Object Layout ★

- Aggregate
- Trivial Class
- Standard-Layout Class
- Plain Old Data (POD)
- Hierarchy

Polymorphism

Polymorphism

Polymorphism (meaning “having multiple forms”) is the capability of an entity of *mutating* its behavior in accordance with the specific usage *context*

Polymorphism dispatch can be implemented at

- **Compile-time** (static polymorphism): when the called instance is known before the program start
- **Run-time** (dynamic polymorphism): when the called instance is known only during the execution, i.e. depends on run-time values

In C++, the term **polymorphic** is strongly associated with dynamic polymorphism (*overriding*)

Function Binding

Connecting the function call to the function body is called *Binding*

- In **Early Binding** or *Static Binding* or *Compile-time Binding*, the compiler identifies the type of object at compile-time
 - the program can jump directly to the function address
- In **Late Binding** or *Dynamic Binding* or *Run-time binding*, the run-time identifies the type of object at execution-time and *then* matches the function call with the correct function definition
 - the program has to read the address held in the pointer and then jump to that address (less efficient since it involves an extra level of indirection)

C++ achieves **late binding** by declaring a **virtual** function

Polymorphism Forms

- **A-hoc polymorphism:** when it involves to a set of individually specified types, e.g. function overloading

```
void f(int);  
void f(double);
```

- *Parametric polymorphism:* when it involves generic types, e.g. templates

```
template<typename T>  
void f(T);
```

- *Subtyping:* when it operates on elements of subtypes, e.g. virtual functions

```
// B : A  
void f(A*); // also works for B if the called function are virtual
```

- *Preprocessing*

```
#define ADD(x, y) x + y // ADD(3, 4) or ADD(3.0, 4.0)
```

- *Function/Operator overloading*

```
void f(int);  
void f(double);
```

- *Templates*

```
template<typename T>  
void f(T); // f(3) or f(3.0)
```

- *Virtual functions* (see next slides)

| Mechanism | Implementation | Form |
|--------------------------------------|----------------|------------|
| Preprocessing | static | Parametric |
| Function/Operator overloading | static | Ad-hoc |
| Template | static | Parametric |
| Virtual function | dynamic | Subtyping |

Dynamic Polymorphism in C++

- At run-time, objects of a *base class* behaves as objects of a *derived class*
- A **Base** class may define and implement polymorphic methods, and **derived** classes can **override** them, which means they provide their own implementations, invoked at run-time depending on the context

```
struct A {  
    void f() { cout << "A"; }  
};  
struct B : A {  
    void f() { cout << "B"; }  
};  
void g(A& a) { a.f(); } // accepts A and B  
                        // note: g(B&) would only accept B  
A a; B b;  
g(a);    // print "A"  
g(b);    // print "A" not "B"!!!
```

Polymorphism - virtual method

```
struct A {  
    virtual void f() { cout << "A"; }  
}; // now "f()" is virtual, evaluated at run-time  
  
struct B : A {  
    virtual void f() { cout << "B"; }  
}; // now "B::f()" overrides "A::f()", evaluated at run-time  
  
void g(A& a) { a.f(); } // accepts A and B  
  
A a;  
B b;  
g(a); // print "A"  
g(b); // NOW, print "B"!!!
```

The `virtual` keyword is not necessary in derived classes but it improves the *readability* and clarity the intention

When virtual works

```
struct A {  
    virtual void f() { cout << "A"; }  
};  
  
struct B : A {  
    void f() { cout << "B"; }  
};  
  
void f(A& a) { a.f(); } // ok, print "B"  
void g(A* a) { a->f(); } // ok, print "B"  
void h(A a) { a.f(); } // does not work with pass-by value!! print "A"  
  
B b;  
f(b); // print "B"  
g(&b); // print "B"  
h(b); // print "A" (cast to A)
```

Polymorphism Dynamic Behavior

```
struct A {  
    virtual void f() { cout << "A"; }  
};  
  
struct B : A {  
    void f() { cout << "B"; }  
};  
  
A* get_object(bool selectA) {  
    return (selectA) ? new A() : new B();  
}  
  
get_object(true)->f(); // print "A"  
get_object(false)->f(); // print "B"
```

vtable

The **virtual table** (vtable) is a lookup table of functions used to resolve function calls and support *dynamic dispatch* (late binding)

A *virtual table* contains one entry for each `virtual` function that can be called by objects of the class. Each entry in this table is simply a function pointer that points to the *most-derived* function accessible by that class

The compiler adds a *hidden* pointer to the base class which points to the virtual table for that class (`sizeof` considers the vtable pointer)

```
struct A {  
    virtual void f();  
    virtual void g();  
};  
  
struct B : A {  
    void f();  
};
```

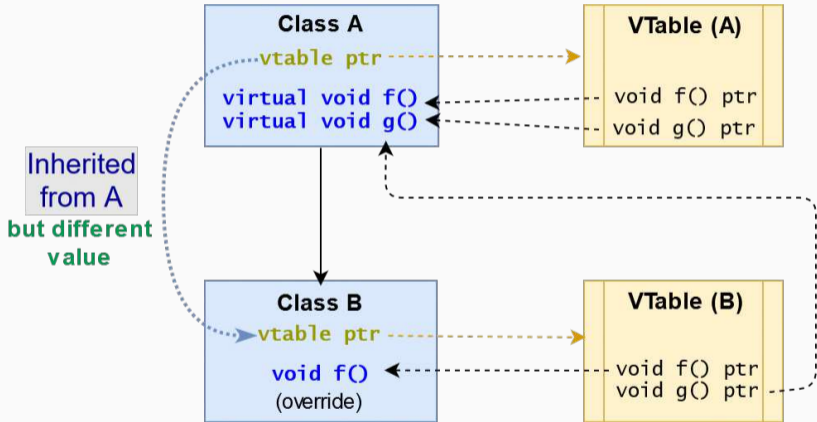

Does the vtable really exist? (answer: YES)

```
struct A {  
    int x = 3;  
    virtual void f() { cout << "abc"; }  
};  
  
A* a1 = new A;  
A* a2 = (A*) malloc(sizeof(A));  
  
cout << a1->x; // print "3"  
cout << a2->x; // undefined value!!  
a1->f(); // print "abc"  
a2->f(); // segmentation fault ☠
```

Lesson learned: Never use `malloc` in C++

Virtual Method Notes

virtual classes allocate one extra pointer (hidden)

```
struct A {  
    virtual void f1();  
    virtual void f2();  
};  
  
class B : A {};  
  
cout << sizeof(A); // 8 bytes (vtable pointer)  
cout << sizeof(B); // 8 bytes (vtable pointer)
```

override Keyword (C++11)

The `override` keyword ensures that the function is `virtual` and is overriding a `virtual` function from a base class

It forces the compiler to check the base class to see if there is a `virtual` function with this exact signature

`override` implies `virtual` (`virtual` should be omitted)

```
struct A {  
    virtual void f(int a);           // a "float" value is casted to "int"  
};                                   // ***  
  
struct B : A {  
    void f(int a) override;         // ok  
    void f(float a);                // (still) very dangerous!!  
};                                   // ***  
  
// void f(float a) override;        // compile error not safe  
// void f(int a) const override;    // compile error not safe  
};  
  
// *** f(3.3f) has a different behavior between A and B
```

final Keyword

final Keyword (C++11)

The `final` keyword prevents inheriting from classes or overriding methods in derived classes

```
struct A {  
    virtual void f(int a) final; // "final" method  
};  
  
struct B : A {  
    // void f(int a); // compile error f(int) is "final"  
    void f(float a); // dangerous (still possible)  
}; // "override" prevents these errors  
  
struct C final { // cannot be extended  
};  
// struct D : C { // compile error C is "final"  
// };
```

Virtual Methods (Common Error 1)

All classes with at least one `virtual` method should declare a `virtual destructor`

```
struct A {
    ~A() { cout << "A"; }    // <-- here the problem (not virtual)
    virtual void f(int a) {}
};

struct B : A {
    int* array;
    B() { array = new int[1000000]; }
    ~B() { delete[] array; }
};

//-----
void destroy(A* a) {
    delete a;    // call ~A()
}

B* b = new B;
destroy(b); // without virtual, ~B() is not called
            // destroy() prints only "A" -> huge memory leak!!
```

Virtual Methods (Common Error 2)

Do not call virtual methods in constructor and destructor

- *Constructor*: The derived class is not ready until constructor is completed
- *Destructor*: The derived class is already destroyed

```
struct A {  
    A() { f(); } // what instance is called? "B" is not ready  
                // it calls A::f(), even though A::f() is virtual  
    virtual void f() { cout << "Explosion"; }  
};  
struct B : A {  
    B() = default; // call A(). Note: A() may be also implicit  
  
    void f() override { cout << "Safe"; }  
};  
  
B b; // call B(), print "Explosion", not "Safe"!!
```

Virtual Methods (Common Error 3)

Do not use default parameters in virtual methods

Default parameters are not inherited

```
struct A {
    virtual void f(int i = 5) { cout << "A::" << i << "\n"; }
    virtual void g(int i = 5) { cout << "A::" << i << "\n"; }
};
struct B : A {
    void f(int i = 3) override { cout << "B::" << i << "\n"; }
    void g(int i)      override { cout << "B::" << i << "\n"; }
};
A a; B b;
a.f();    // ok, print "A::5"
b.f();    // ok, print "B::3"

A& ab = b;
ab.f();   // !!! print "B::5" // the virtual table of A
                                   // contains f(int i = 5) and
ab.g();   // !!! print "B::5" // g(int i = 5) but it points
                                   // to B implementations
```

Pure Virtual Method

A **pure virtual method** is a function that must be implemented in derived classes (concrete implementation)

Pure virtual functions can have or not have a body

```
struct A {  
    virtual void f() = 0; // pure virtual without body  
    virtual void g() = 0; // pure virtual with body  
};  
void A::g() {} // pure virtual implementation (body) for g()  
  
struct B : A {  
    void f() override {} // must be implemented  
    void g() override {} // must be implemented  
};
```

A class with one *pure virtual function* cannot be instantiated

```
struct A {  
    virtual void f() = 0;  
};  
  
struct B1 : A {  
    // virtual void f() = 0; // implicitly declared  
};  
  
struct B2 : A {  
    void f() override {}  
};  
  
// A a; // "A" has a pure virtual method  
// B1 b1; // "B1" has a pure virtual method  
B2 b2; // ok
```

Abstract Class and Interface

- A class is **interface** if it has only *pure virtual* functions and optionally (*suggested*) a virtual destructor. Interfaces do not have implementation or data
- A class is **abstract** if it has at least one *pure virtual* function

```
struct A {           // INTERFACE
    virtual ~A();   // to implement
    virtual void f() = 0;
};

struct B {           // ABSTRACT CLASS
    B() {}          // abstract classes may have a constructor
    virtual void g() = 0; // at least one pure virtual
protected:
    int x;          // additional data
};
```

Inheritance Casting and Run-time Type Identification ★

Hierarchy Casting

Class-casting allows implicit or explicit conversion of a class into another one across its hierarchy

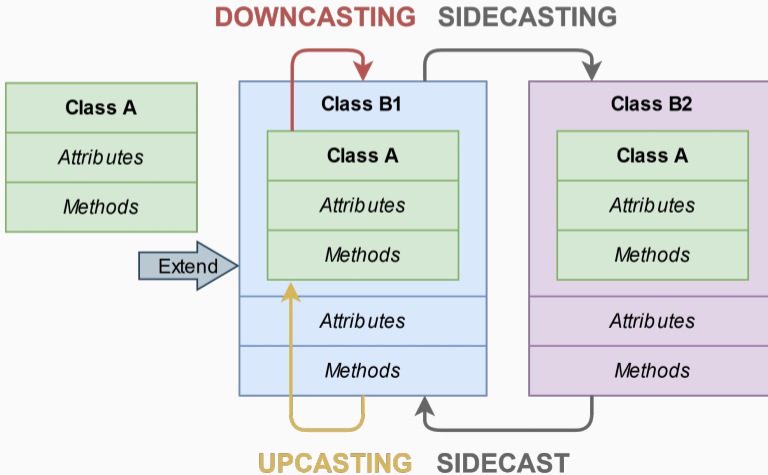

Hierarchy Casting

Upcasting Conversion between a derived class reference or pointer to a base class

- It can be *implicit* or *explicit*
- It is safe
- `static_cast` or `dynamic_cast` // see next slides

Downcasting Conversion between a base class reference or pointer to a derived class

- It is only *explicit*
- It can be dangerous
- `static_cast` or `dynamic_cast`

Sidecasting (*Cross-cast*) Conversion between a class reference or pointer to another class of the same hierarchy level

- It is only *explicit*
- It can be dangerous
- `dynamic_cast`

Upcasting and Downcasting Example

```
struct A {  
    virtual void f() { cout << "A"; }  
};  
  
struct B : A {  
    int var = 3;  
    void f() override { cout << "B"; }  
};  
  
A a;  
B b;  
A& a1 = b; // implicit cast upcasting  
  
static_cast<A&>(b).f();           // print "B" upcasting  
static_cast<B&>(a).f();           // print "A" downcasting  
cout << b.var;                    // print 3 (no cast)  
cout << static_cast<B&>(a).var; // potential segfault!!! downcasting
```

Sidecasting Example

```
struct A {
    virtual void f() { cout << "A"; }
};

struct B1 : A {
    void f() override { cout << "B1"; }
};

struct B2 : A {
    void f() override { cout << "B2"; }
};

B1 b1;
B2 b2;
dynamic_cast<B2&>(b1).f();    // sidecasting, throw std::bad_cast
dynamic_cast<B1&>(b2).f();    // sidecasting, throw std::bad_cast
// static_cast<B1&>(b2).f(); // compile error
```

RTTI

Run-Time Type Information (RTTI) is a mechanism that allows the type of object to be *determined at runtime*

C++ expresses RTTI through three features:

- `dynamic_cast` keyword: conversion of polymorphic types
- `typeid` keyword: identifying the exact type of object
- `type_info` class: type information returned by the `typeid` operator

RTTI is available only for classes that are *polymorphic*, which means they have *at least one* virtual method

typeid and typeid

typeid class has the method name() which returns the name of the type

```
struct A {  
    virtual void f() {}  
};  
  
struct B : A {};  
  
A a;  
B b;  
A& a1 = b; // implicit upcasting  
cout << typeid(a).name(); // print "1A"  
cout << typeid(b).name(); // print "1B"  
cout << typeid(a1).name(); // print "1B"
```

`dynamic_cast`, differently from `static_cast`, uses *RTTI* for deducing the correctness of the output type

This operation happens at run-time and it is expensive

`dynamic_cast<New>(Obj)` has the following properties:

- Convert between a derived class `Obj` to a base class `New` → *upcasting*.
`New/Obj` are both pointers or references
- Throw `std::bad_cast` if `New/Obj` are *references* and `New/Obj` cannot be converted
- Returns `NULL` if `New/Obj` are *pointers* and `New/Obj` cannot be converted

dynamic_cast Example 1

```
struct A {  
    virtual void f() { cout << "A"; }  
};  
  
struct B : A {  
    void f() override { cout << "B"; }  
};  
  
A a;  
B b;  
dynamic_cast<A&>(b).f();    // print "B" upcasting  
  
// dynamic_cast<B&>(a).f(); // throw std::bad_cast  
// wrong downcasting  
  
dynamic_cast<B*>(&a);      // returns nullptr  
// wrong downcasting
```

dynamic_cast Example 2

```
struct A {
    virtual void f() { cout << "A"; }
};
struct B : A {
    void f() override { cout << "B"; }
};

A* get_object(bool selectA) {
    return (selectA) ? new A() : new B();
}

void g(bool value) {
    A* a = get_object(value);
    B* b = dynamic_cast<B*>(a); // downcasting + check
    if (b != nullptr)
        b->f();           // executed only when it is safe
}
```

Operator Overloading

Operator Overloading

Operator Overloading

Operator overloading is a special case of polymorphism in which some *operators* are treated as polymorphic functions and have different behaviors depending on the type of its arguments

```
struct Point {  
    int x, y;  
  
    Point operator+(const Point& p) const {  
        return {x + p.x, y + p.y};  
    }  
};  
  
Point a{1, 2};  
Point b{5, 3};  
Point c = a + b; // "c" is (6, 5)
```

Operator Overloading

| Category | Operators |
|---------------------------------------|---------------------------|
| Arithmetic | + - * / % ++ -- |
| Comparison | == != < <= > >= <=> |
| Bitwise | & ^ ~ << >> |
| Logical | ! && |
| Compound Assignment Arithmetic | += -= *= /= %= |
| Compound Assignment Bitwise | >>= <<= = &= ^= |
| Subscript | [] |
| Function call | () |
| Address-of, Reference, Dereferencing | & -> ->* * |
| Memory | new new[] delete delete[] |
| Comma | , |

- Categories not in bold are rarely used in practice
- Operators that cannot be overloaded: ? . .* :: sizeof typeof

Comparison Operator `operator<`

Relational and comparison operators `operator<`, `<=`, `==`, `>=`, `>` are used for comparing two objects

In particular, the `operator<` is used to determine the ordering of a set of objects (e.g. `sort`)

```
#include <algorithm>
struct A {
    int x;

    bool operator<(A a) const {
        return x * x < a.x * a.x;
    }
};
A array[] = {5, -1, 4, -7};
std::sort(array, array + 4);
// array: {-1, 4, 5, -7}
```

C++20 allows overloading the **spaceship operator** `<=>` for replacing all comparison operators `operator<`, `<=`, `==`, `>=`, `>`

```
struct A {
    bool operator==(const A&) const;
    bool operator!=(const A&) const;
    bool operator<(const A&) const;
    bool operator<=(const A&) const;
    bool operator>(const A&) const;
    bool operator>=(const A&) const;
};

// replaced by
struct B {
    int operator<=>(const B&) const;
};
```

```
#include <compare>

struct Obj {
    int x;

    auto operator<=>(const Obj& other) {
        return x - other.x; // or even better "x <=> other.x"
    }
};

Obj a{3};
Obj b{5};
a < b;      // true, even if the operator< is not defined
a == b;    // false
a <=> b < 0; // true
```

The compiler can also generate the code for the *spaceship operator* `= default`, even for multiple fields and arrays, by using the default comparison semantic of its members

```
#include <compare>

struct Obj {
    int x;
    char y;
    short z[2];

    auto operator<=>(const Obj&) const = default;
    // if x == other.x, then compare y
    // if y == other.y, then compare z
    // if z[0] == other.z[0], then compare z[1]
};
```

The *spaceship operator* can use one of the following ordering:

strong ordering

- if `a` is equivalent to `b`, `f(a)` is also equivalent to `f(b)`
- exactly one of `<`, `==`, or `>` must be true
- integral types, e.g. `int`, `char`

weak ordering

- if `a` is equivalent to `b`, `f(a)` may not be equivalent to `f(b)`
- exactly one of `<`, `==`, or `>` must be true
- rectangles, e.g. `R{2, 5} == R{5, 2}`

partial ordering

- if `a` is equivalent to `b`, `f(a)` may not be equivalent to `f(b)`
- `<`, `==`, or `>` may all be false
- floating-point `float`, e.g. `NaN`

Subscript Operator operator []

The **array subscript operator** [] allows accessing to an object in an array-like fashion

The operator accepts everything as parameter, not just integers

```
struct A {  
    char permutation[] {'c', 'b', 'd', 'a', 'h', 'y'};  
  
    char& operator[](char c) { // read/write  
        return permutation[c - 'a'];  
    }  
    char operator[](char c) const { // read only  
        return permutation[c - 'a'];  
    }  
};  
  
A a;  
a['d'] = 't';
```

Multidimensional Subscript Operator operator[]

C++23 introduces the *multidimensional subscript operator* and replaces the standard behavior of the *comma operator*

```
struct A {
    int operator[](int x) { return x; }
};
struct B {
    int operator[](int x, int y) { return x * y; } // not allowed before C++23
};

int main() {
    A a;
    cout << a[3, 4]; // return 4 (bug)
    B b;
    cout << b[3, 4]; // return 12, C++23
}
```

Function Call Operator operator()

The **function call operator** `operator()` is generally overloaded to create objects which behave like functions, or for classes that have a primary operation (see Basic Concepts IV lecture)

```
#include <numeric> // for std::accumulate

struct Multiply {
    int operator()(int a, int b) const {
        return a * b;
    }
};

int array[] = { 2, 3, 4 };
int factorial = std::accumulate(array, array + 3, 1, Multiply{});
cout << factorial; // 24
```

static operator() and static operator[]

C++23 introduces the `static` version of the *function call operator* `operator()` and the *subscript operator* `operator[]` to avoid passing the `this` pointer

```
#include <numeric> // for std::accumulate

struct Multiply {
// int      operator()(int a, int b); // declaration only
    static int operator()(int a, int b); // best efficiency, no need to access
};                                     // internal data members

struct MyArray {
// int      operator[](int x);
    static int operator[](int x); // best efficiency
};

int array[] = { 2, 3, 4 };
int factorial = std::accumulate(array, array + 3, 1, Multiply{});
```

The **conversion operator** `operator T()` allows objects to be either implicitly or explicitly (casting) converted to another type

```
class MyBool {
    int x;
public:
    MyBool(int x1) : x{x1} {}

    operator bool() const { // implicit return type
        return x == 0;
    }
};

MyBool my_bool{3};
bool b = my_bool; // b = false, call operator bool()
```

C++11 **Conversion operators** can be marked **explicit** to prevent implicit conversions. It is a good practice as for class constructors

```
struct A {
    operator bool() { return true; }
};

struct B {
    explicit operator bool() { return true; }
};

A a;
B b;
bool c1 = a;
// bool c2 = b; // compile error: explicit
bool c3 = static_cast<bool>(b);
```

Return Type Overloading Resolution ★

```
struct A {  
    operator float() { return 3.0f; }  
    operator int()   { return 2;   }  
};  
  
auto f() {  
    return A{};  
}  
  
float x = f();  
int   y = f();  
cout << x << " " << y; // x=3.0f, y=2
```

Increment and Decrement Operators `operator++/--`

The increment and decrement operators `operator++`, `operator--` are used to update the value of a variable by one unit

```
struct A {
    int* ptr;
    int pos;
    A& operator++() { // Prefix notation (++var):
        ++ptr; // returns the new copy of the object by-reference
        ++pos;
        return *this;
    }
    A operator++(int a) { // Postfix notation (var++):
        A tmp = *this; // returns the old copy of the object by-value
        ++ptr;
        ++pos;
        return tmp;
    }
};
```

The **assignment operator** `operator=` is used to copy values from one object to another *already existing* object

```
#include <algorithm> //std::fill, std::copy
struct Array {
    char* array;
    int size;

    Array(int size1, char value) : size{size1} {
        array = new char[size];
        std::fill(array, array + size, value);
    }
    ~Array() { delete[] array; }

    Array& operator=(const Array& x) { .... } // --> see next slide
};
Array a{5, 'o'}; // ["ooooo"]
Array b{3, 'b'}; // ["bbb"]
```

- First option:

```
Array& operator=(const Array& x) {  
    if (this == &x)           // (1) Check for self assignment  
        return *this;  
    delete[] array;           // (2) Release class resources  
    size = x.size;           // (3) Re-initialize class resources  
    array = new int[x.size];  
    std::copy(x.array, x.array + size, array); // (4) deep copy  
    return *this;  
}
```

- Second option (less intuitive):

```
Array& operator=(Array x) { // pass by-value  
    swap(*this, x);         // now we need a swap function for A  
    return *this;           // x is destroyed at the end  
}                            // --> see next slide
```

swap method:

```
friend void swap(A& x, A& y) {  
    using std::swap;  
    swap(x.size, y.size);  
    swap(x.array, y.array);  
}
```

- **why using std::swap?** if swap(x, y) finds a better match, it will use that instead of std::swap
- **why friend?** it allows the function to be used from outside the structure/class scope

stackoverflow.com/questions/3279543

stackoverflow.com/questions/5695548

Stream Operator operator<<

The **stream operation operator<<** can be overloaded to perform input and output for user-defined types

```
#include <iostream>

struct Point {
    int x, y;

    friend std::ostream& operator<<(std::ostream& stream,
                                   const Point& point) {
        stream << "(" << point.x << "," << point.y << ")";
        return stream;
    }
    // operator<< is a member of std::ostream -> need friend
}; // implementation and definition can be splitted (not suggested for operator<<)
Point point{1, 2};
std::cout << point; // print "(1, 2)"
```

Operators Precedence

Operators preserve **precedence** and **short-circuit** properties

```
struct MyInt {
    int x;

    int operator^(int exp) { // exponential
        int ret = 1;
        for (int i = 0; i < exp; i++)
            ret *= x;
        return ret;
    }
};

MyInt x{3};
int y = x^2;
cout << y; // 9
int z = x^2 + 2;
cout << z; // 81 !!!
```

Binary Operators Note

Binary operators should be implemented as friend methods

```
struct A {}; struct C {};  
  
struct B : A {  
    bool operator==(const A& x) { return true; }  
};  
struct D : C {  
    friend bool operator==(const C& x, const C& y) { return true; } // inline  
};  
// bool operator==(const C& x, const C& y) { return true; } // out-of-line  
  
A a; B b; C c; D d;  
b == a;    // ok  
// a == b; // compile error // "A" does not have == operator  
c == d;    // ok, use operator==(const C&, const C&)  
d == c;    // ok, use operator==(const C&, const C&)
```

C++ Object Layout



The term **layout** refers to how an object is arranged in memory

C++ defines four types of *layouts*:

- aggregate
- trivial copyable
- standard layout
- plain-old data (POD)

Such *layouts* are important to understand how the C++ objects interact with pure C API and for optimization purposes, e.g. pass in registers, `memcpy`, and serialization

Aggregate

An **aggregate** [↗](#) is an array, struct, or class which supports *aggregate initialization* (form of list-initialization) through curly braces syntax `{}`

- No *user-provided* constructors
- No `private` / `protected` *non-static* data members and *base class*
- No `virtual` functions
- * No base classes, until **C++17**
- * No *brace-or-equal-initializers* for non-static data members, until **C++14**
- R Apply recursively to *base classes* *non-static* data members

No restrictions:

- *Non-static* uninitialized (until **C++14**) data and function members
- `static` data and function members

```
struct Aggregate {
    int x;          // ok, public member
    int y[3];      // ok, arrays are also fine
    int z { 3 };  // only C++14

    Aggregate() = default;           // ok, defaulted constructor
    Aggregate& operator=(const& Aggregate); // ok, function
private:                             // copy-assignment
    void f() {}                       // ok, private function
};

struct NotAggregate1 {
    NotAggregate1(); // !! user-provided constructor
    virtual void f(); // !! virtual function
};

class NotAggregate2 : NotAggregate1 { // !! the base class is not an aggregate
    int x; // !! x is private
    NotAggregate1 y; // !! y is not an aggregate (recursive property)
};
```

```
struct Aggregate1 {
    int x;
    struct Aggregate2 {
        int a;
        int b[3];
    } y;
};

int array1[3] = {1, 2, 3};
int array2[3] = {1, 2, 3};
Aggregate1 agg1 = {1, {2, {3, 4, 5}}};
Aggregate1 agg2 = {1, {2, {3, 4, 5}}};
Aggregate1 agg3 = {1, 2, 3, 4, 5};
```

Trivial Class

A **Trivial Class** is a class **trivial copyable** (supports memcopy)

Trivial copyable:

- No *user-provided* copy/move/default constructors, *destructor*, and copy/move assignment operators
- No **virtual** functions
- Apply recursively to *base* classes and *non-static* data members

No restrictions:

- *User-declared* constructors different from copy/move/default
- Functions or **static**, *non-static* data members initialization
- **protected** / **private** members

```
struct NonTrivial {
    NonTrivial();    // !! user-provided constructor
    virtual void f(); // !! virtual function
};

struct Trivial1 {
    Trivial1() = default;    // ok, defaulted constructor
    Trivial1(int) {};        // ok, user-default constructor
    static int x;            // ok, static member
    void f();                // ok, function
private:
    int z { 3 }              // ok, private and initialized
};

struct Trivial2 : Trivial1 { // ok, base class is trivial
    int Trivial1[3];         // ok, array of trivials is trivial
};
```

Standard-Layout

A **standard-layout class** [↗](#) is a class with the same memory layout of the equivalent C struct or union (useful for communicating with other languages)

- No **virtual** functions
 - Only one control access (**public** / **protected** / **private**) for all **non-static** data members
 - No base classes with **non-static** data members
 - No base classes of the same type as the first **non-static** data member
- R Apply recursively to *base* classes and **non-static** data members

```
struct StandardLayout1 {
    StandardLayout1(); // ok, user-provided constructor
    void f();          // ok, non-virtual function
};

class StandardLayout2 : StandardLayout1 {
    int x, y;          // ok, both are private
    StandardLayout1 y; // ok, 'y' is not the first data member
};

struct StandardLayout4 : StandardLayout1, StandardLayout2 {
    // ok, can use multiple inheritance as long as only
    // one class in the hierarchy has non-static data members
};
```

Plain Old Data (POD)

Plain Old Data (POD): Trivial copyable (**T**) + Standard-Layout (**S**)

(T) No *user-provided* copy/move/default constructors, *destructor*, and copy/move assignment operators

(S) Only one control access (`public` / `protected` / `private`) for all *non-static* data members

(S) No base classes with *non-static* data members

(S) No base classes of the same type as the first *non-static* data member

(T, S) No `virtual` functions

R Apply recursively to *base* classes and *non-static* data members

C++11 provides three utilities to check if a type is POD, Trivial Copyable, Standard-Layout

- `std::is_pod` checks for POD, deprecated in C++20
- `std::is_trivially_copyable` checks for trivial copyable
- `std::is_standard_layout` checks for standard-layout

```
#include <type_traits>

struct A {
    int x;
private:
    int y;
};

cout << std::is_trivially_copyable_v<A>; // true
cout << std::is_standard_layout_v<A>;   // false
cout << std::is_pod_v<A>;                // false
```

Object Layout Hierarchy

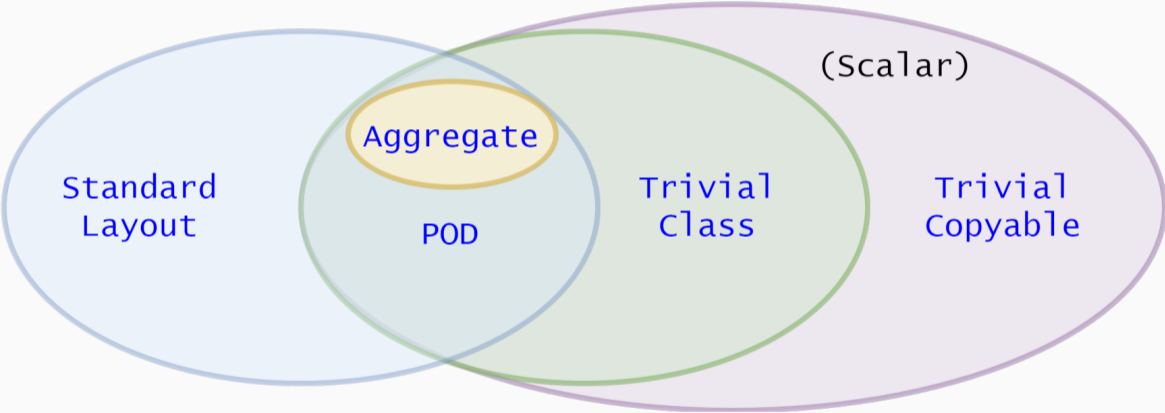

Modern C++ Programming

9. TEMPLATES AND META-PROGRAMMING I

FUNCTION TEMPLATES AND COMPILE-TIME UTILITIES

Federico Busato

2024-11-05

1 Function Template

- Overview
- Template Instantiation
- Template Parameters
- Template Parameters - Default Value
- Overloading
- Specialization

2 Template Variable

3 Template Parameter Types

- Generic Type Notes
- auto Placeholder
- Class Template Parameter Type
- Array and Pointer Types ★
- Function Type ★

4 Compile-Time Utilities

- `static_assert`
- `using` Keyword
- `decltype` Keyword

5 Type Traits

- Overview
- Type Traits Library
- Type Manipulation



C++ Templates: The Complete Guide (2nd)

*D. Vandevoorde, N. M. Josuttis,
D. Gregor, 2017*

Function Template

Template

A **template** is a mechanism for generic programming to provide a “*schema*” (or *placeholders*) to represent the structure of an entity

In C++, *templates* are a compile-time functionality to represent:

- A family of **functions**
- A family of **classes**
- A family of **variables** C++14

The problem: We want to define a function to handle different types

```
int add(int a, int b) {  
    return a + b;  
}  
  
float add(float a, float b) { // overloading  
    return a + b;  
}  
  
char    add(char a, char b)    { ... } // overloading  
ClassX  add(ClassX a, ClassX b) { ... } // overloading
```

- Redundant code!!
- How many functions we have to write!?
- If the user introduces a new type we have to write another function!!

Function Template

A **function template** is a function schema that operates with *generic* types (independent of any particular type) or concrete values

A function template works with multiple types without repeating the entire code for each of them

```
template<typename T> // or template<class T>
T add(T a, T b) {
    return a + b;
}

int    c1 = add(3, 4);      // c1 = 7
float  c2 = add(3.0f, 4.0f); // c2 = 7.0f
```

Templates: Benefits and Drawbacks

Benefits

- **Generic Programming:** Less code and reusable. Reduce *redundancy*, better *maintainability* and *flexibility*
- **Performance.** Computation can be done/optimized at compile-time → *faster*

Drawbacks

- **Readability.** “With respect to C++, the syntax and idioms of templates are *esoteric* compared to conventional C++ programming, and templates can be very difficult to understand” [wikipedia] → hard to read, cryptic error messages
- **Compile Time/Binary Size.** Templates are implicitly instantiated for every distinct parameters

Template Instantiation

Template Instantiation

The **template instantiation** is the substitution of template parameters with concrete values or types

The compiler *automatically* generates a **function implementation** for each template instantiation

```
template<typename T>
T add(T a, T b) {
    return a + b;
}
add(3, 4);           // generates: int   add(int, int)
add(3.0f, 4.0f);    // generates: float add(float, float)
add(2, 6);          // already generated
// other instances are not generated
// e.g. char add(char, char)
```

Implicit and Explicit Template Instantiation

Implicit Template Instantiation

Implicit template instantiation occurs when the compiler generates code depending on the *deduced argument types* or the *explicit template arguments* and only when the definition is needed

Explicit Template Instantiation

Explicit template instantiation occurs when the compiler generates code depending only on the *explicit template arguments* specified in the declaration. Useful when dealing with multiple translation units to reduce the binary size

Implicit and Explicit Template Instantiation

```
template<typename T>
void f(T a) {}

void g() {
    f(3);           // generates: void f(int) → implicit
    f<short>(3.0); // generates: void f(short) → implicit
}

template void f<int>(int); // generates: void f(int) → explicit
```

Template Parameters

Template Parameters

Template Parameters are the names following the `template` keyword

```
template<typename T>
void f() {}

f<int>();
```

`typename T` is the **template parameter**

`int` is the **template argument**

A **template parameter** can be a generic type, i.e. `typename`, as well as a non-type template parameters (NTTP), e.g. `int`, `enum`, etc.

The **template argument** of a generic type is a built-in or user-declared type, while a concrete value for a non-type template parameter

int parameter

```
template<int A, int B>
int add_int() {
    return A + B; // sum is computed at compile-time
}
// e.g. add_int<3, 4>();
```

enum parameter

```
enum class Enum { Left, Right };

template<Enum Z>
int add_enum(int a, int b) {
    return (Z == Enum::Left) ? a + b : a;
}
// e.g. add_enum<Enum::Left>(3, 4);
```

- **Ceiling division**

```
template<int DIV, typename T>
T ceil_div(T value) {
    return (value + DIV - 1) / DIV;
}
// e.g. ceil_div<5>(11); // returns 3
```

- **Rounded division**

```
template<int DIV, typename T>
T round_div(T value) {
    return (value + DIV / 2) / DIV;
}
// e.g. round_div<5>(11); // returns 2 (2.2)
```

Since DIV is known at compile-time, the compiler can heavily optimize the division (almost for every number, not just for power of two)

C++11 Template parameters can have default values

```
template<int A = 3, int B = 4>
void print1() { cout << A << ", " << B; }

template<int A = 3, int B>                // still possible, but little sense
void print2() { cout << A << ", " << B; }

print1<2, 5>();    // print 2, 5
print1<2>();       // print 2, 4 (B: default)
print1<>();        // print 3, 4 (A,B: default)
print1();          // print 3, 4 (A,B: default)

print2<2, 5>();    // print 2, 5
// print2<2>();    compile error
// print2<>();     compile error
// print2();       compile error
```

Template parameters may have no name

```
void f() {}

template<typename = void>
void g() {}

int main() {
    g(); // generated
}
```

f() is always generated in the final code

g() is generated in the final code only if it is called

C++11 Unlike function parameters, template parameters can be initialized by previous values

```
template<int A, int B = A + 3>
void f() {
    cout << B;
}

template<typename T, int S = sizeof(T)>
void g(T) {
    cout << S;
}

f<3>(); // B is 6
g(3); // S is 4
```

Function Template Overloading

Template Functions can be *overloaded*

```
template<typename T>
T add(T a, T b) {
    return a + b;
} // e.g add(3, 4);

template<typename T>
T add(T a, T b, T c) { // different number of parameters
    return a + b + c;
} // e.g add(3, 4, 5);
```

Also, templates themselves can be *overloaded*

```
template<int C, typename T>
T add(T a, T b) { // it is not in conflict with
    return a + b + C; // T add(T a, T b)
} // "C" is part of the signature
```

Template Specialization

Template specialization refers to the concrete implementation for a specific combination of template parameters

The problem:

```
template<typename T>
bool compare(T a, T b) {
    return a < b;
}
```

The direct comparison between two floating-point values is dangerous due to rounding errors

Solution: Template specialization

```
template<>
bool compare<float>(float a, float b) {
    return ... // a better floating point implementation
}
```

Full Specialization: *Function* templates can be specialized only if **ALL** template arguments are specialized

Template Variable

Template Variable

C++14 allows variables with templates

A template variable can be considered a special case of a *class template* (see next lecture)

```
template<typename T>
constexpr T pi{ 3.1415926535897932385 }; // variable template

template<typename T>
T circular_area(T r) {
    return pi<T> * r * r; // pi<T> is a variable template instantiation
}

circular_area(3.3f); // float
circular_area(3.3); // double
// circular_area(3); // compile error, narrowing conversion with "pi"
```

Template Parameter Types

Template Parameter Types

Template parameters can be:

- *integral type*
- `enum`, `enum class`
- *floating-point type* C++20
- `auto` placeholder C++17
- *class literals* and *concepts* C++20
- *generic type* `typename`

and rarely:

- *function*
- *reference/pointer* to global `static` function or object
- *pointer to member type*
- `nullptr_t` C++14

Generic Type Notes

Pass multiple values and floating-point types

```
template<float V> // only in C++20
void print_float() {}

template<typename T>
void print() {
    cout << T::x << ", " << T::y;
}

struct Multi {
    static const int x = 1;
    static constexpr float y = 2.0f;
};

print<Multi>(); // print "1, 2"
```

auto Placeholder

C++17 introduces automatic deduction of *non-type* template parameters with the `auto` keyword

```
template<int X, int Y>
void f() {}

template<typename T1, T1 X, typename T2, T2 Y>
void g1() {} // before C++17

template<auto X, auto Y>
void g2() {}

f<2u, 2u>();           // X: int, Y: int
g1<int, 2, char, 'a'>(); // X: int, Y: char
g2<2, 'a'>();         // X: int, Y: char
```

Class Template Parameter Type

C++20 A *non-type template parameter* of a **class literal type**:

- A *class literal* is a class that can be assigned to `constexpr` variable
- All *base classes* and *non-static data members* are public and non-mutable
- All *base classes* and *non-static data members* have the same properties

```
#include <array>
struct A {
    int x;
    constexpr A(int x1) : x{x1} {}
};
template<A a>
void f() { std::cout << a.x; }

template<std::array array>
void g() { std::cout << array[2]; }

f<A{5}>();           // print '5'
g<std::array{1,2,3}>(); // print '3'
```

Array and pointer

```
template<int* ptr>    // pointer
void g() {
    cout << ptr[0];
}

template<int (&array)[3]> // reference
void f() {
    cout << array[0];
}

int array[] = {2, 3, 4}; // global

int main() {
    f<array>(); // print 2
    g<array>(); // print 2
}
```

Class member

```
struct A {
    int x    = 5;
    int y[3] = {4, 2, 3};
};

template<int A::*x>    // pointer to
void h1() {}          // member type

template<int (A::*y)[3]> // pointer to
void h2() {}          // member type

int main() {
    h1<&A::x>();
    h2<&A::y>();
}
```

Function

```
template<int (*F)(int, int)> // <-- signature of "f"
int apply1(int a, int b) {
    return F(a, b);
}

int f(int a, int b) { return a + b; }

int g(int a, int b) { return a * b; }

template<decltype(f) F> // alternative syntax
int apply2(int a, int b) {
    return F(a, b);
}

int main() {
    apply1<f>(2, 3); // return 5
    apply2<g>(2, 3); // return 6
}
```

Compile-Time Utilities

static_assert

C++11 `static_assert` is used to test an assertion at compile-time, e.g. `sizeof`, literals, templates, `constexpr`

If the *static assertion* fails, the program does not compile

```
static_assert(2 + 2 == 4, "test1"); // ok, it compiles
static_assert(2 + 2 == 5, "test2"); // compile error, print "test2"
```

C++17: assertions without messages

```
template<typename T, typename R>
void f() { static_assert(sizeof(T) == sizeof(R)); }

f<int, unsigned>(); // ok, it compiles
// f<int, char>(); // compile error
```

C++26: assertions with text formatting

```
static_assert(sizeof(T) != 4, std::format("test1 with sizeof(T)={}", sizeof(T)));
```

using keyword (C++11)

The `using` keyword introduces an *alias-declaration* or *alias-template*

- `using` is an enhanced version of `typedef` with a more readable syntax
- `using` can be combined with templates, as opposite to `typedef`
- `using` is useful to simplify complex template expression
- `using` allows introducing new names for partial and full specializations

```
typedef int distance_t; // equal to:
```

```
using distance_t = int;
```

```
typedef void (*function)(int, float); // equal to:
```

```
using function = void (*)(int, float);
```

Full/Partial specialization alias:

```
template<typename T, int Size>
struct Vector {};           // see next lecture for further details
                           // on class template

template<int Size>
using Bitset = Vector<bool, Size>; // partial specialization alias

using IntV4 = Vector<int, 4>;    // full specialization alias
```

Accessing a type within a structure:

```
struct A {
    using type = int;
};
using Alias = A::type;
```

C++11 `decltype` keyword captures the type of *entity* or an *expression*

- `decltype` never executes, it is always evaluated at compile-time

```
int      x = 3;
int&     y = x;
const int z = 4;
int      array[2];
void     f(int, float);

decltype(x)      d1; // int
decltype(2 + 3.0) d2; // double
decltype(y)      d3; // int&
decltype(z)      d4; // const int
decltype(array)  d5; // int[2]
decltype(f(1, 2.0f)) d6; // void

using function = decltype(f);
```

```
bool f(int) { return true; }

struct A {
    int x;
};
int x = 3;
const A a{4};

decltype(x)    d1;    // int
decltype((x)) d2 = x; // int&

decltype(f)    d3;    // bool (int)
decltype((f))  d4 = f; // bool (&)(int)

decltype(a.x)  d5;    // int
decltype((a.x)) d6 = x; // const int
```

C++11

```
template<typename T, typename R>
decltype(T{} + R{}) add(T x, R y) {
    return x + y;
}
```

```
unsigned v1 = add(1, 2u);
double   v2 = add(1.5, 2u);
```

C++14

```
template<typename T, typename R>
auto add(T x, R y) {
    return x + y;
}
```

Type Traits

Introspection

Introspection is the ability to inspect a type and query its properties

Reflection

Reflection is the ability of a computer program to examine, introspect, and modify its own structure and behavior

C++ provides compile-time reflection and introspection capabilities through type traits

Type traits (C++11)

Type traits define a compile-time interface to *query* or *modify* the properties of types

The problem:

```
template<typename T>
T integral_div(T a, T b) {
    return a / b;
}

integral_div(7, 2);      // returns 3 (int)
integral_div(71, 21);   // returns 3 (long int)
integral_div(7.0, 3.0); // !!! a floating-point value is not an integral type
```

Two alternatives: (1) Specialize (2) Type Traits + `static_assert`

If we want to **prevent floating-point/other objects division at compile-time**, a first solution consists in specialize for all integral types

```
template<typename T>
T integral_div(T a, T b); // declaration (error for other types)

template<>
char integral_div<char>(char a, char b) { // specialization
    return a / b;
}
template<>
int integral_div<int>(int a, int b) { // specialization
    return a / b;
}
...unsigned char
...short
...
```

The best solution is to use **type traits**

```
#include <type_traits>      // <-- std type traits library
template<typename T>
T integral_div(T a, T b) {
    static_assert(std::is_integral<T>::value,
                  "integral_div accepts only integral types");
    return a / b;
}
```

`std::is_integral<T>` is a struct with a static constexpr boolean field `value`. `value` is true if `T` is `bool`, `char`, `short`, `int`, `long`, `long long`, false otherwise.

C++17 provides utilities to improve the readability of type traits

```
std::is_integral_v<T>; // std::is_integral<T>::value
```

- `is_integral` checks for an integral type (`bool` , `char` , `unsigned char` , `short` , `int` , `long` , etc.)
- `is_floating_point` checks for a floating-point type (`float` , `double`)
- `is_arithmetic` checks for a integral or floating-point type
- `is_signed` checks for a signed type (`float` , `int` , etc.)
- `is_unsigned` checks for an unsigned type (`unsigned` , `bool` , etc.)
- `is_enum` checks for an enumerator type (`enum` , `enum class`)
- `is_void` checks for (`void`)
- `is_pointer` checks for a pointer (`T*`)
- `is_null_pointer` checks for a (`nullptr`) C++14

Entity type queries:

- `is_reference` checks for a reference (`T&`)
- `is_array` checks for an array (`T (&)[N]`)
- `is_function` checks for a function type

Class queries:

- `is_class` checks for a class type (`struct` , `class`)
- `is_abstract` checks for a class with at least one pure virtual function
- `is_polymorphic` checks for a class with at least one virtual function

Type property queries:

- `is_const` checks if a type is `const`

Type relation:

- `is_same<T, R>` checks if `T` and `R` are the same type
- `is_base_of<T, R>` checks if `T` is base of `R`
- `is_convertible<T, R>` checks if `T` can be converted to `R`

Example - const Deduction

```
#include <type_traits>
template<typename T>
void f(T x) { cout << std::is_const_v<T>; }

template<typename T>
void g(T& x) { cout << std::is_const_v<T>; }

template<typename T>
void h(T& x) {
    cout << std::is_const_v<T>;
    x = nullptr; // ok, it compiles for T: (const int)*
}

const int a = 3;
f(a); // print false, "const" drop in pass by-value
g(a); // print true
const int* b = new int;
h(b); // print false!! T: (const int)*
```

Example - Type Relation

```
#include <type_traits>
template<typename T, typename R>
T add(T a, R b) {
    static_assert(std::is_same_v<T, R>, "T and R must have the same type");
    return a + b;
}
add(1, 2);          // ok
// add(1, 2.0); // compile error, "T and R must have the same type"
```

```
#include <type_traits>
struct A {};
struct B : A {};

std::is_base_of_v<A, B>           // true
std::is_convertible_v<int, float> // true
```

Type Manipulation

Type traits allow also to manipulate types by using the `type` field

Example: produce `unsigned` from `int`

```
#include <type_traits>

using U = typename std::make_unsigned<int>::type; // see next lecture to understand
                                                // why 'typename' is needed here

U y = 5; // unsigned
```

C++14 provides utilities to improve the readability of type traits

```
std::make_unsigned_t<T>; // instead of 'typename std::make_unsigned<T>::type'
```

Signed and Unsigned types:

- `make_signed` makes a signed type
- `make_unsigned` makes an unsigned type

Pointers and References:

- `remove_pointer` remove pointer (`T*` → `T`)
- `remove_reference` remove reference (`T&` → `T`)
- `add_pointer` add pointer (`T` → `T*`)
- `add_lvalue_reference` add reference (`T` → `T&`)

const specifiers:

- `remove_const` remove `const` (`const T` → `T`)
- `add_const` add `const`

Other type transformation:

- `common_type`<T, R> returns the common type between `T` and `R`
- `conditional`<pred, T, R> returns `T` if `pred` is `true`, `R` otherwise
- `decay`<T> returns the same type as a function parameter passed by-value

Type Manipulation Example

```
#include <type_traits>
template<typename T>
void f(T ptr) {
    using R = std::remove_pointer_t<T>;
    R x = ptr[0]; // char
}
```

```
template<typename T>
void g(T x) {
    using R = std::add_const_t<T>;
    R y = 3;
    // y = 4;    // compile error
}
```

```
char a[] = "abc";
f(a); // T: char*
g(3); // T: int
```

std::common_type Example

```
#include <type_traits>

template<typename T, typename R>
std::common_type_t<R, T> // <-- return type
add(T a, R b) {
    return a + b;
}

// we can also use decltype to derive the result type
using result_t = decltype(add(3, 4.0f));
result_t x = add(3, 4.0f);
```

std::conditional Example

```
#include <type_traits>

template<typename T, typename R>
auto f(T a, R b) {
    constexpr bool pred = sizeof(T) > sizeof(R);
    using S = std::conditional_t<pred, T, R>;
    return static_cast<S>(a) + static_cast<S>(b);
}

f( 2, 'a'); // return 'int'
f( 2, 2ull); // return 'unsigned long long'
f(2.0f, 2ull); // return 'unsigned long long'
```

Modern C++ Programming

10. TEMPLATES AND META-PROGRAMMING II

CLASS TEMPLATES , SFINAE, AND CONCEPTS

Federico Busato

2024-11-05

1 Class Template

- Class Specialization
- Class Template Constructor

2 Constructor Template Automatic Deduction (CTAD)

3 Class Template - Advanced Concepts

- Class + Function - Specialization
- Dependent Names - `typename` and `template` Keywords
- Class Template Hierarchy and `using`
- `friend` Keyword
- Template Template Arguments

4 Template Meta-Programming

5 SFINAE: Substitution Failure Is Not An Error

- Function SFINAE
- Class SFINAE

6 Variadic Templates

- Folding Expression
- Variadic Class Template ★

7 C++20 Concepts

- Overview
- `concept` Keyword
- `requires` Clause
- `requires` Expression
- `requires` Expression + Clause
- `requires` Clause + Expression
- `requires` and `constexpr`
- Nested `requires`

8 Template Debugging

Class Template

Class Template

Similarly to function templates, **class templates** are used to build a family of classes

```
template<typename T>
struct A { // class template (typename template)
    T x = 0;
};
template<int N1>
struct B { // class template (numeric template)
    int N = N1;
};

A<int>    a1; // a1.x is int    x = 0
A<float>  a2; // a2.x is float  x = 0.0f
B<1>     b1; // b1.N is 1
B<2>     b2; // b2.N is 2
```

The *main difference* with template functions is that classes can be partially specialized

Note: Every class specialization (both partial and full) is a completely new class, and it does not share anything with the generic class

```
template<typename T, typename R>
struct A {};           // generic class template

template<typename T>
struct A<T, int> {};   // partial specialization

template<>
struct A<float, int> {}; // full specialization
```

```
template<typename T, typename R>
struct A {           // GENERIC class template
    T x;
};

template<typename T>
struct A<T, int> {   // PARTIAL specialization
    T y;
};

A<float, float> a1;
a1.x;    // ok, generic template
// a1.y; // compile error

A<float, int> a2;
a2.y;    // ok, partial specialization
// a2.x; // compile error
```

Example 1: Implement a Simple Type Trait

```
template<typename T, typename R> // GENERIC template declaration
struct is_same {
    static constexpr bool value = false;
};

template<typename T>
struct is_same<T, T> {           // PARTIAL template specialization
    static constexpr bool value = true;
};

cout << is_same< int,  char>::value; // print false, generic template
cout << is_same<float, float>::value; // print true, partial template
```

Example 2: Check if a Pointer is const

```
#include <type_traits>

// std::true_type and std::false_type contain a field "value"
//   set to true or false respectively

template<typename T>
struct is_const_pointer : std::false_type {}; // GENERIC template declaration

template<typename R> // PARTIAL specialization
struct is_const_pointer<const R*> : std::true_type {};

cout << is_const_pointer<int*>::value; // print false, generic template
cout << is_const_pointer<const int*>::value; // print true, partial template
cout << is_const_pointer<int* const>::value; // print false, generic template
```

Example 3: Compare Class Templates

```
#include <type_traits>

template<typename T>
struct A {};

template<typename T, typename R>
struct Compare : std::false_type {};           // GENERIC template declaration

template<typename T, typename R>
struct Compare<A<T>, A<R>> : std::true_type {}; // PARTIAL specialization

cout << Compare<int, float>::value;           // false, generic template
cout << Compare<A<int>, A<int>>::value;       // true, partial template
cout << Compare<A<int>, A<float>>::value;     // true, partial template
```

Class Template Constructor

Class template arguments don't need to be repeated if they are the default ones

```
template<typename T>
struct A {
    A(const A& x); // A(const A<T>& x);

    A f();        // A<T> f();
};
```

Constructor Template Automatic Deduction (CTAD)

Constructor Template Automatic Deduction (CTAD)

C++17 introduces *automatic* deduction of class template arguments in constructor calls

```
template<typename T, typename R>
struct A {
    A(T x, R y) {}
};

A<int, float> a1(3, 4.0f); // < C++17
A          a2(3, 4.0f); // C++17

// A<int> a{3, 5}; compile error, "partial" specialization
```

Template deduction guide is a mechanism to instruct the compiler how to map constructor parameter types into class template parameters

```
template<typename T>
struct MyString {
    MyString(T) {}
};

// constructor           class instantiation
MyString(char const*) -> MyString<std::string>; // deduction guide

MyString s{"abc"}; // construct 'MyString<std::string>'
```

CTAD - User-Defined Deduction Guides - Aggregate Example

```
template<typename T>
struct A {
    T x, y;
};

template<typename T>
A(T, T) -> A<T>; // deduction guide
                // not required in C++20+ for aggregates

A a{1, 3};      // construct 'A<int, int>'
```

CTAD - User-Defined Deduction Guides - Independent Argument Example

```
template<int I>
struct A {
    template<typename T>
    A(T) {}
};

template<typename T>
A(T) -> A<sizeof(T)>; // deduction guide

A a{1};                // construct 'A<4>', 4 == sizeof(int)
```

CTAD - User-Defined Deduction Guides - Universal Reference Example

```
#include <type_traits> // std::remove_reference_t

template<typename T>
struct A {
    template<typename R>
    A(R&&) {}
};

template<typename R>
A(R&&) -> A<std::remove_reference_t<R>>; // deduction guide

int x;
A a{x}; // construct 'A<int>' instead of 'A<int&>'
```

CTAD - User-Defined Deduction Guides - Iterator Example

```
#include <type_traits> // std::remove_reference_t
#include <vector>       // std::vector

template<typename T>
struct Container {
    template<typename Iter>
    Container(Iter beg, Iter end) {}
};

template<typename Iter>
Container(Iter b, Iter e) ->           // deduction guide
    Container<typename std::iterator_traits<Iter>::value_type>;

std::vector v{1, 2, 3};
Container c{v.begin(), v.end()}; // construct 'Container<int>'
```

CTAD - User-Defined Deduction Guides - Alias Template

Alias template deduction requires C++20

```
template<typename T>
struct A {
    A(T) {}
};

template<typename T>
A(T) -> A<int>;           // deduction guide

template<typename T>
using B = A<T>;          // alias template

B c{3.0};                // alias template deduction
                        // construct 'A<int>'
```

CTAD User-Defined Deduction Guides - Limitation

Template deduction guide doesn't work within the class scope

```
template<typename T>
struct MyString {
    MyString(T) {}
    MyString f() { return MyString("abc"); } // create 'MyString<const char*>'
};                                           // not 'MyString<std::string>'
MyString(const char*) -> MyString<std::string>; // deduction guide

MyString<const char*> s{"abc"}; // construct 'MyString<const char*>'
```

The problem can be avoided by using a factory

```
template<typename T>
auto make_my_string(const T& x) { return MyString(x); }
```

Class Template - Advanced Concepts

Given a class template and a template member function

```
template<typename T, typename R>
struct A {
    template<typename X, typename Y>
    void f();
};
```

There are two ways to specialize the class/function:

- **Generic class + generic function**
- **Full class specialization + generic/full specialization function**

```
template<typename T, typename R>
template<typename X, typename Y>
void A<T, R>::f() {}
// ok, A<T, R> and f<X, Y> are not specialized

template<>
template<typename X, typename Y>
void A<int, int>::f() {}
// ok, A<int, int> is full specialized
// ok, f<X, Y> is not specialized

template<>
template<>
void A<int, int>::f<int, int>() {}
// ok, A<int, int> and f<int, int> are full specialized
```

```
template<typename T>
template<typename X, typename Y>
void A<T, int>::f() {}
// error A<T, int> is partially specialized
//      (A<T, int> class must be defined before)

template<typename T, typename R>
template<typename X>
void A<T, R>::f<int, X>() {}
// error function members cannot be partially specialized

template<typename T, typename R>
template<>
void A<T, R>::f<int, int>() {}
// error function members of a non-specialized class cannot be specialized
//      (requires a binding to a specific template instantiation at compile-time)
```

Structure templates can have different data members for each specialization.

The compiler needs to know in advance if a symbol within a structure is a type or a static member when the structure template *depends on* another template parameter

The keyword `typename` placed before a *structure template* solves this ambiguous

```
template<typename T>
struct A {
    using type = int;
};

template<typename R>
void g() {
    using X = typename A<R>::type; // "type" is a typename or
    // a data member depending on R
}
```

The `using` keyword can be used to simplify the expression to get the structure type

```
template<typename T>
struct A {
    using type = int;
};

template<typename T>
using AType = typename A<T>::type;

template<typename R>
void g() {
    using X = AType<R>;
}
```

Template Dependent Names - `template` Keyword

The `template` keyword tells the compiler that what follows is a *template name* (*function* or *class*)

note: some recent compilers don't strictly require this keyword in simple cases

```
template<typename T>
struct A {
    template<typename R>
    void g() {}
};

template<typename T> // A<T> is a dependent name (from T)
void f(A<T> a) {
    // a.g<int>(); // compile error g<int> is a dependent name (from int)
    //             // interpreted as: "(a.g < int) > ()"
    a.template g<int>(); // ok
}
```

Class Template Hierarchy and using

Member of class templates can be used *internally* in derived class templates by specifying the particular type of the base class with the keyword `using`

```
template<typename T>
struct A {
    T    x;
    void f() {}
};

template<typename T>
struct B : A<T> {
    using A<T>::x; // needed (otherwise it could be another specialization)
    using A<T>::f; // needed

    void g() {
        x; // without 'using': this->x
        f();
    }
};
```

Virtual functions cannot have template arguments

- **Templates** are a compile-time feature
- **Virtual functions** are a run-time feature

Full story:

The reason for the language disallowing the particular construct is that there are potentially infinite different types that could be instantiating your template member function, and that in turn means that the compiler would have to generate code to dynamically dispatch those many types, which is infeasible

stackoverflow.com/a/79682130

friend Keyword

```
template<typename T>          struct A {};
template<typename T, typename R> struct B {};
template<typename T>          void f() {}
//-----
class C {
    friend void f<int>();           // match only f<int>

    template<typename T> friend void f(); // match all templates

    friend struct A<int>;          // match only A<int>

    template<typename> friend struct A; // match all A templates

    // template<typename T> friend struct B<int, T>;
    //     partial specialization cannot be declared as a friend
};
```

Template Template Arguments

Template template parameters match *templates* instead of concrete types

```
template<typename T> struct A {};  
  
template< template<typename> class R >  
struct B {  
    R<int>    x;  
    R<float> y;  
};  
  
template< template<typename> class R, typename S >  
void f(R<S> x) {} // works with every class with exactly one template parameter  
  
B<A> y;  
f( A<int>() );
```

`class` and `typename` keyword are interchangeably in C++17

Template Meta-Programming

Template Meta-Programming

*“Metaprogramming is the writing of computer programs with the ability to **treat programs as their data**. It means that a program could be designed to read, generate, analyze or transform other programs, and even modify itself while running”*

*“Template meta-programming refers to uses of the C++ template system to **perform computation at compile-time** within the code. Templates meta-programming include compile-time constants, data structures, and complete functions”*

Template Meta-Programming

- **Template Meta-Programming is fast** (runtime)

Template Metaprogramming is computed at compile-time (nothing is computed at run-time)

- **Template Meta-Programming is Turing Complete**

Template Metaprogramming is capable of expressing all tasks that standard programming language can accomplish

- **Template Meta-Programming requires longer compile time**

Template recursion heavily slows down the compile time, and requires much more memory than compiling standard code

- **Template Meta-Programming is complex**

Everything is expressed recursively. Hard to read, hard to write, and also very hard to debug

Example 1: Factorial

```
template<int N>
struct Factorial {      // GENERIC template: Recursive step
    static constexpr int value = N * Factorial<N - 1>::value;
};

template<>
struct Factorial<0> {  // FULL SPECIALIZATION: Base case
    static constexpr int value = 1;
};

constexpr int x = Factorial<5>::value; // 120
// int y = Factorial<-1>::value;      // Infinite recursion :)
```

Example 1: Factorial (Notes)

The previous example can be easily written as a `constexpr` in C++14

```
template<typename T>
constexpr int factorial(T value) {
    T tmp = 1;
    for (int i = 2; i <= value; i++)
        tmp *= i;
    return tmp;
};
```

Advantages:

- Easy to read and write (easy to debug)
- Faster compile time (no recursion)
- Works with different types (typename T)
- Works at run-time *and* compile-time

Example 2: Log2

```
template<int N>
struct Log2 {    // GENERIC template: Recursive step
    static_assert(N > 0, "N must be greater than zero");

    static constexpr int value = 1 + Log2<N / 2>::value;
};

template<>
struct Log2<1> { // FULL SPECIALIZATION: Base case
    static constexpr int value = 0;
};

constexpr int x = Log2<20>::value; // 4
```

Example 3: Log

```
template<int A, int B>
struct Max { // utility
    static constexpr int value = A > B ? A : B;
};

template<int N, int BASE>
struct Log { // GENERIC template: Recursive step
    static_assert(N > 0, "N must be greater than zero");
    static_assert(BASE > 0, "BASE must be greater than zero");
    // Max is used to avoid Log<0, BASE>

    static constexpr int TMP = Max<1, N / BASE>::value;
    static constexpr int value = 1 + Log<TMP, BASE>::value;
};

template<int BASE>
struct Log<1, BASE> { // PARTIAL SPECIALIZATION: Base case
    static constexpr int value = 0;
};

constexpr int x = Log<20, 2>::value; // 4
```

Example 4: Unroll (Compile-time/Run-time Mix) ★

```
template<int NUM_UNROLL, int STEP = 0>
struct Unroll { // GENERIC template: Recursive step
    template<typename Op>
    static void run(Op op) {
        op(STEP);
        Unroll<NUM_UNROLL, STEP + 1>::run(op);
    }
};

template<int NUM_UNROLL>
struct Unroll<NUM_UNROLL, NUM_UNROLL> { // PARTIAL SPECIALIZATION: Base case
    template<typename Op>
    static void run(Op) {}
};

auto lambda = [](int step) { cout << step << ", "; };
Unroll<5>::run(lambda); // print "0, 1, 2, 3, 4"
```

**SFINAE:
Substitution Failure
Is Not An Error**

SFINAE

Substitution Failure Is Not An Error (SFINAE) applies during overload resolution of function templates. When substituting the deduced type for the template parameter fails, the specialization is discarded from the overload set *instead* of causing a compile error

The Problem

```
template<typename T>
T ceil_div(T value, T div);

template<>
unsigned ceil_div<unsigned>(unsigned value, unsigned div) {
    return (value + div - 1) / div;
}

template<>
int ceil_div<int>(int value, int div) { // handle negative values
    return (value > 0) ^ (div > 0) ?
        (value / div) : (value + div - 1) / div;
}
```

What about `long long int`, `long long unsigned`, `short`, `unsigned short`,
etc.?

std::enable_if Type Trait

The common way to adopt SFINAE is using the `std::enable_if/std::enable_if_t` type traits

`std::enable_if` allows a function template or a class template specialization to include or exclude itself from a set of matching functions/classes

```
template<bool Condition, typename T = void>
struct enable_if {
    // "type" is not defined if "Condition == false"
};
template<typename T>
struct enable_if<true, T> {
    using type = T;
};
```

helper alias: `std::enable_if_t<T>` instead of `typename std::enable_if<T>::type`

```
#include <type_traits> // std::is_signed_v, std::enable_if_t
```

```
template<typename T>  
std::enable_if_t<std::is_signed_v<T>>  
f(T) {  
    cout << "signed";  
}
```

```
template<typename T>  
std::enable_if_t<!std::is_signed_v<T>>  
f(T) {  
    cout << "unsigned";  
}
```

```
f(1); // print "signed"  
f(1u); // print "unsigned"
```

```
#include <type_traits>

template<typename T>
void f(std::enable_if_t<std::is_signed_v<T>, T>) {
    cout << "signed";
}

template<typename T>
void f(std::enable_if_t<!std::is_signed_v<T>, T>) {
    cout << "unsigned";
}

f(1); // print "signed"
f(1u); // print "unsigned"
```

```
#include <type_traits>

template<typename T>
void f(T,
      std::enable_if_t<std::is_signed_v<T>, int> = 0) {
    cout << "signed";
}

template<typename T>
void f(T,
      std::enable_if_t<!std::is_signed_v<T>, int> = 0) {
    cout << "unsigned";
}

f(1); // print "signed"
f(1u); // print "unsigned"
```

```
#include <type_traits>

template<typename T,
        std::enable_if_t<std::is_signed_v<T>, int> = 0>
void f(T) {}

template<typename T,
        std::enable_if_t<!std::is_signed_v<T>, int> = 0>
void f(T) {}

f(4);
f(4u);
```

```
#include <type_traits>

template<typename T, typename R>           // (1)
decltype(T{} + R{}) add(T a, R b) {      // T{} + R{} is not possible with 'A'
    return a + b;
}

template<typename T, typename R>         // (2)
std::enable_if_t<std::is_class_v<T>, T> // 'int' is not a class
add(T a, R b) {
    return a;
}

struct A {};

add(1, 2u);    // call (1)
add(A{}, A{}); // call (2)
// if 'A' supports operator+, then we have a conflict
```

Function SFINAE Example - Array vs. Pointer

```
#include <type_traits>

template<typename T, int Size>
void f(T (&array)[Size]) {} // (1)

//template<typename T, int Size>
//void f(T* array) {} // (2)

template<typename T>
std::enable_if_t<std::is_pointer_v<T>>
f(T ptr) {} // (3)

int array[3];
f(array); // It is not possible to call (1) if (2) is present
// The reason is that 'array' decays to a pointer
// Now with (3), the code calls (1)
```

Function SFINAE Notes

The wrong way to achieve SFINAE

```
template<typename T, typename = std::enable_if_t<std::is_signed_v<T>>  
void f(T) {}  
  
// template<typename T, typename = std::enable_if_t<!std::is_signed_v<T>>  
// void f(T) {}  
// compile error redefinition of the second template parameter
```

Using `std::enable_if_t` for the *return type* prevents `auto` deduction

```
// template<typename T>  
// std::enable_if_t<std::is_signed_v<T>, auto> f(T) {}  
// compile error auto is not allowed here
```

Class SFINAE

```
#include <type_traits>

template<typename T, typename Enable = void>
struct A;

template<typename T>
struct A<T, std::enable_if_t<std::is_signed_v<T>>> {
};

template<typename T>
struct A<T, std::enable_if_t<!std::is_signed_v<T>>> {
};

A<int>      a1;
A<unsigned> a2;
```

SFINAE can be also used to check if a structure has a specific data member or type

Let consider the following structures:

```
struct A {  
    static int x;  
    int      y;  
    using type = int;  
};  
  
struct B {};
```

```
#include <type_traits>

template<typename T, typename = void>
struct has_x : std::false_type {};

template<typename T>
struct has_x<T, decltype((void) T::x)> : std::true_type {};

template<typename T, typename = void>
struct has_y : std::false_type {};

template<typename T>
struct has_y<T, decltype((void) std::declval<T>().y)> : std::true_type {};

has_x< A >::value; // returns true
has_x< B >::value; // returns false
has_y< A >::value; // returns true
has_y< B >::value; // returns false
```

```
template<typename...>
using void_t = void; // included in C++17 <utility>

template<typename T, typename = void>
struct has_type : std::false_type {};

template<typename T>
struct has_type<T,
               std::void_t<typename T::type> > : std::true_type {};

has_type< A >::value; // returns true
has_type< B >::value; // returns false
```

Support Trait for Stream Operator ★

```
template<typename T>
using EnableP = decltype( std::declval<std::ostream&>() <<
                          std::declval<T>() );

template<typename T, typename = void>
struct is_stream_supported : std::false_type {};

template<typename T>
struct is_stream_supported<T, EnableP<T>> : std::true_type {};

struct A {};

is_stream_supported<int>::value; // returns true
is_stream_supported<A>::value;  // returns false
```

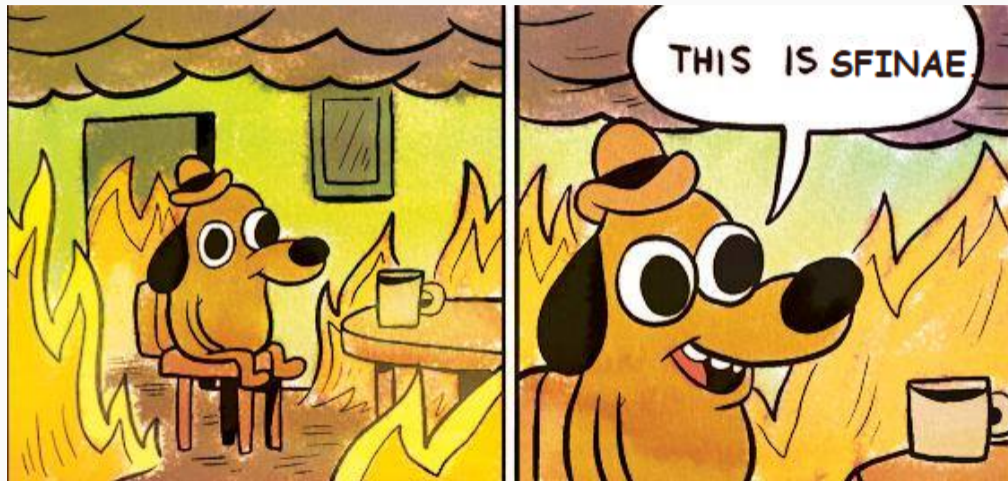

Variadic Templates

Variadic template (C++11)

A **variadic template** captures a *parameter pack* of arguments, which hold an arbitrary number of values or types

```
template<typename... TArgs> // Variadic typename -> parameter pack: ... TArgs
void f(TArgs... args) {}    // pack expansion    -> pattern:      TArgs
```

A **parameter pack** is introduced by an identifier `TArgs` prefixed by an *ellipsis* `... TArgs`. Once captured, a *parameter pack* can later be used in a *pattern* expanded by an *ellipsis* `...`

A **pack expansion** is equivalent to a comma-separated list of instances of the *pattern*

A **pattern** is a *set of tokens* containing the identifiers of one or more *parameter packs*. When a *pattern* contains more than one *parameter pack*, all packs must have the same length

```
template<typename... TArgs>
void f(TArgs... args) {           // Typename expansion
    int values[] = {args...};    // Arguments expansion
}
f(1, 2, 3);
```

The pack `TArgs` expands in a *template-argument-list*, i.e. list of template arguments

The pack `args` expands in an *initializer-list*, i.e. list of values

The number of variadic arguments can be retrieved with the `sizeof...` operator

```
sizeof...(args) // e.g. 3
```

Note: variadic arguments must be the last one in the declaration

Example 1

```
// BASE CASE
template<typename T, typename R>
auto add(T a, R b) {
    return a + b;
}

// RECURSIVE CASE
template<typename T, typename... TArgs> // Variadic typename
auto add(T a, TArgs... args) {        // Typename expansion
    return a + add(args...);          // Arguments expansion
}

add(2, 3.0);           // 5
add(2, 3.0, 4);       // 9
add(2, 3.0, 4, 5);   // 14
// add(2);           // compile error the base case accepts only two arguments
```

Example 2 - Function Unpack

```
template<typename T, typename... TArgs>
auto add(T a, TArgs... args); // see previous slides

struct A {
    int v;
    int f() { return v; }
};

template<typename... TArgs>
int f(TArgs... args) {
    return add(args.f()...); // equivalent to: 'A{1}.f(), A{2}.f(), A{3}.f()'
}

f(A{1}, A{2}, A{3}); // return 6
```

Example 3 - Function Application

```
template<typename T, typename... TArgs>
auto add(T a, TArgs... args); // see previous slides

template<typename T>
T square(T value) { return value * value; }

//-----

template<typename... TArgs>
auto add_square(TArgs... args) {
    return add(square(args)...); // square() is applied to each
}                                // variadic argument

add_square(2, 2, 3.0f); // returns 17.0f
```

Example 4 - Type Expansion

```
template<typename... TArgs>
int g(TArgs... args) {}

template<typename... TArgs>
int f(TArgs... args) {
    g<std::make_unsigned_t<TArgs>...>(args...);
}

f(1, 2, 3);
```

Function Initializer List Types

```
template<typename... TArgs>
void f(TArgs... args) {}           // pass by-value

template<typename... TArgs>
void g(const TArgs&... args) {}    // pass by-const reference

template<typename... TArgs>
void h(TArgs*... args) {}         // pass by-pointer

template<int... Sizes>
void l(int (&...arrays)[Sizes]) {} // pass a list of array references

int a[] = {1, 2};
int b[] = {1, 2, 3};
f(1, 2.0);
h(a, b);
l(a, b); // same as g()
```

Other Notes

Parameter pack can be also used to create a **homogeneous variadic function parameters**

```
template<int... IntSeq>
void f(IntSeq... seq) {} // accepts only integers
```

Variadic templates can be also applied to lambdas with *generic parameters* (C++14) and *concepts* (C++20)

```
auto lambda = [](auto... args) {};

void f(std::floating_point auto... args) {}
```

Advanced Usages ★

Besides *initializer-lists*, *template-argument-list*, parameter pack can be used in: *capture list*, *constructor initializer-list*, `using` declaration

```
template<typename... BaseClasses>
struct A : BaseClasses... {           // : BaseClass_1, BaseClass_2, ...
    A(int v) : BaseClasses...{v} {} // BaseClass_1{v}, BaseClass_2{v}, ...

    using BaseClasses::f;
// equivalent to:
//     using BaseClass_1::f;
//     using BaseClass_2::f;
//     ...
};

void f(auto... args) {
    auto lambda = [arg&...](){}; // capture by-reference
}
```

C++17 Folding expressions perform a *fold* of a template parameter pack over any binary operator in C++ (+, *, ,, +=, &&, <= etc.)

Unary/Binary folding

```
template<typename... Args>
auto add_unary(Args... args) { // Unary folding
    return (... + args);      // unfold: 1 + 2.0f + 3ull
}

template<typename... Args>
auto add_binary(Args... args) { // Binary folding
    return (1 + ... + args);   // unfold: 1 + 1 + 2.0f + 3ull
}

add_unary(1, 2.0f, 3ll); // returns 6.0f (float)
add_binary(1, 2.0f, 3ll); // returns 7.0f (float)
```

Example 1 - Extract The Last Argument

```
template<typename... TArgs>
int f(TArgs... args) {
    return (args, ...); // the comma operator discards left values
}                       // same as (... , args)

f(1, 2, 3); // return 3
```

Example 2 - Function Application

Same example of “Variadic Template - Function Application” ... but shorter

```
template<typename T>
T square(T value) { return value * value; }

template<typename... TArgs>
auto add_square(TArgs... args) {
    return (square(args) + ...); // square() is applied to each
}                                // variadic argument

add_square(2, 2, 3.0f); // returns 17.0f
```

Variadic Template and Classes

```
template<int... NArgs>
struct Add;           // data structure declaration

template<int N1, int N2>
struct Add<N1, N2> { // BASE case
    static constexpr int value = N1 + N2;
};

template<int N1, int... NArgs>
struct Add<N1, NArgs...> { // RECURSIVE case
    static constexpr int value = N1 + Add<NArgs...>::value;
};

Add<2, 3, 4>::value; // returns 9
// Add<>;           // compile error no match
// Add<2>::value;  // compile error
// call Add<N1, NArgs...>, then Add<>
```

Variadic Class Template ★

Variadic Template can be used to build recursive data structures

```
template<typename... TArgs>
struct Tuple;           // data structure declaration

template<typename T>
struct Tuple<T> {      // base case
    T value;           // specialization with one parameter
};

template<typename T, typename... TArgs>
struct Tuple<T, TArgs...> { // recursive case
    T value;           // specialization with more
    Tuple<TArgs...> tail; // than one parameter
};

Tuple<int, float, char> t1 { 2, 2.0, 'a' };
t1.value;               // 2
t1.tail.value;         // 2.0
t1.tail.tail.value;   // 'a'
```

Get function arity at compile-time:

```
template <typename T>
struct GetArity;

// generic function pointer
template<typename R, typename... Args>
struct GetArity<R(*) (Args...)> {
    static constexpr int value = sizeof...(Args);
};

// generic function reference
template<typename R, typename... Args>
struct GetArity<R(&) (Args...)> {
    static constexpr int value = sizeof...(Args);
};

// generic function object
template<typename R, typename... Args>
struct GetArity<R(Args...)> {
    static constexpr int value = sizeof...(Args);
};
```

```
void f(int, char, double) {}

int main() {
    // function object
    GetAriy<decltype(f)>::value;

    auto& g = f;
    // function reference
    GetAriy<decltype(g)>::value;

    // function reference
    GetAriy<decltype((f))>::value;

    auto* h = f;
    // function pointer
    GetAriy<decltype(h)>::value;
}
```

Get operator() (and lambda) arity at compile-time:

```
template <typename T>
struct GetArity;

template<typename R, typename C, typename... Args>
struct GetArity<R(C::*)(Args...)> {           // class member
    static constexpr int value = sizeof...(Args);
};

template<typename R, typename C, typename... Args>
struct GetArity<R(C::*)(Args...) const> {    // "const" class member
    static constexpr int value = sizeof...(Args);
};

struct A {
    void operator()(char, char) {}
    void operator()(char, char) const {}
};

GetArity<A>::value;           // call GetArity<R(C::*)(Args...)>
GetArity<const A>::value;   // call GetArity<R(C::*)(Args...) const>
```

C++20 Concepts

C++20 Concepts

C++20 introduces **concepts** as an extension for *templates* to enforce *constraints*, which specifies the *requirements* on template arguments

Concepts allows performing compile-time validation of template arguments

Advantages compared to SFINAE (`std::enable_if`):

- Concepts are easier to read and write
- Clear compile-time messages for debugging
- Faster compile time

Keyword:

`concept` Constrain

`requires` Constrain list/Requirements, *clause* and *expression*

-
- The concept behind C++ concepts
 - Constraints and concepts
 - What are C++20 concepts and constraints? How to use them?

The Problem

Goal: define a function to sum only arithmetic types

```
template<typename T>
T add(T valueA, T valueB) {
    return valueA + valueB;
}

struct A {};

add(3, 4);           // ok
// add(A{}, A{}); // not supported
```

SFINAE solution (ugly, verbose):

```
template<typename T>
std::enable_if_t<std::is_arithmetic_v<T>, T>
add(T valueA, T valueB) {
    return valueA + valueB;
}
```

concept Keyword

```
[template arguments]  
concept [name] = [compile-time boolean expression];
```

Example: arithmetic type concept

```
template<typename T>  
concept Arithmetic = std::is_arithmetic_v<T>;
```

- *Template argument constrain*

```
template<Arithmetic T>  
T add(T valueA, T valueB) {  
    return valueA + valueB;  
}
```

- `auto` *deduction constrain* (*constrained* `auto`)

```
auto add(Arithmetic auto valueA, Arithmetic auto valueB) {  
    return valueA + valueB;  
}
```

requires Clause

```
requires [compile-time boolean expression or Concept]
```

it acts like SFINAE

- After *template parameter list*

```
template<typename T>
requires Arithmetic<T>
T add(T valueA, T valueB) {
    return valueA + valueB;
}
```

- After *function declaration*

```
template<typename T>
T add(T valueA, T valueB) requires (sizeof(T) == 4) {
    return valueA + valueB;
}
```

requires Clause and concept Notes

Concepts and *requirements* can have *multiple* statements. It must be a *primary expression*, e.g. `constexpr` value (not a `constexpr` function) or a sequence of *primary expressions* joined with the operator `&&` or `||`

```
template<typename T>  
concept Arithmetic2 = std::is_arithmetic_v<T> && sizeof(T) >= 4;
```

Concepts and *requirements* can be used together

```
template<Arithmetic T>  
requires (sizeof(T) >= 4)  
T add(T valueA, T valueB) {
```

A **requires expression** is a *compile-time* expression of type `bool` that defines the **constraints** on template arguments

```
requires [(arguments)] {  
    [SFINAE constrain];    // or  
    requires [predicate];  
} -> bool
```

```
template<typename T>  
concept MyConcept = requires (T a, T b) { // First case: SFINAE constrains  
    a + b;           // Req. 1 - support add operator  
    a[0];           // Req. 2 - support subscript operator  
    a.x;           // Req. 3 - has "x" data member  
    a.f();         // Req. 4 - has "f" function member  
    typename T::type; // Req. 5 - has "type" field  
};
```

Concept library

```
#include <concept>

template<typename T>
concept MyConcept2 = requires (T a, T b) {
    {*a + 1} -> std::convertible_to<float>; // Req. 6 - can be deferred and the sum
                                           // with an integer is convertible
                                           // to float
    {a * a} -> std::same_as<int>;          // Req. 7 - "a * a" must be valid and
                                           // the result type is "int"
};
```

requires Expression + Clause

`requires expression` can be combined with `requires clause`

(see `requires` definition, second case) to compute a boolean value starting from SFINAE expressions

```
template<typename T>
concept Arithmetic = requires {           // expression -> bool (zero args)
    T::value;                             // clause      -> direct SFINAE
    requires std::is_arithmetic_v<T>;    // clause      -> SFINAE from boolean
};
```

```
template<typename T>
concept MyConcept = requires (T value) { // expression -> bool (one arg)
    requires sizeof(value) >= 4;        // clause      -> SFINAE from boolean
    requires std::is_floating_point_v<T>; // clause      -> SFINAE from boolean
};
```

requires Clause + Expression

`requires clause` can be combined with `requires expression` to apply SFINAE (functions, structures) starting from a compile-time *boolean expressions*

```
template<typename T>
void f(T a) requires requires { T::value; }
//           clause -> SFINAE followed by
//           expression -> bool (zero args)
{ }
```

```
template<typename T>
T increment(T a) requires requires (T x) { x + 1; }
//           clause -> SFINAE followed by
//           expression -> bool (one arg)
{
    return a + 1;
}
```

requires and constexpr

Some examples:

- `constexpr bool has_member_x = requires(T v){ v.x; };`

- `if constexpr (MyConcept<T>)`

- `static_assert(requires(T v){ ++v; }, "no increment");`

- ```
template<typename Iter>
constexpr bool is_iterator() {
 return requires(Iter it) { *it++; };
}
```

# Nested requires

Nested `requires` example:

```
requires(Iter v) { // expression -> bool (one arg)
 Iter it;
 requires requires(typename Iter::value_type v) {
// clause -> SFINAE followed by
// expression -> bool (one arg)
 v = *it; // read
 *it = v; // write
 };
}
```

# Template Debugging

---

# Template Debugging

- `-ftemplate-backtrace-limit=<N>` Maximum number of template instantiation notes for a single *warning/error* to `N`, default 10  
`N=1` is useful when looking only at the lasted instantiation (much less verbose output). `N=100` (or higher) if you are looking at all template instantiations (rare)
- `-ftemplate-depth=<N>` Set the maximum instantiation depth for template classes to `N`, default 900
- `-Wfatal-errors` Abort compilation on the first error occurred rather than trying to keep going and printing further error messages

- `-fdiagnostics-show-template-tree` Display the templates as an indented text tree

```
map<
 [...],
 map<
 [float != double],
 [...]>>
```

# Modern C++ Programming

## 11. TRANSLATION UNITS I

### LINKAGE AND ONE DEFINITION RULE

---

*Federico Busato*

2024-11-05



## **1** Basic Concepts

- Translation Unit
- Local and Global Scope
- Linkage

## 2 Storage Class and Duration

- Storage Duration
- Storage Class
- `static` Keyword
- Anonymous Namespace
- `extern` Keyword

## **3** Linkage of `const` and `constexpr` Variables

- Static Initialization Order Fiasco

## **4** Linkage Summary

## **5** Dealing with Multiple Translation Units

- Class in Multiple Translation Units

## 6 One Definition Rule (ODR)

- Global Variable Issues
- ODR - Point (3)
- `inline` Functions/Variables
- `constexpr` and `inline`

## 7 ODR - Function Template

- Cases
- `extern` Keyword

## **8** ODR - Class Template

- Cases
- extern Keyword

## **9** ODR Undefined Behavior and Summary

# Basic Concepts

---

## Header File and Source File

**Header files** allow defining interfaces (.h, .hpp, .hxx), while keeping the implementation in separated **source files** (.c, .cpp, .cxx).

## Translation Unit

A **translation unit** (or *compilation unit*) is the basic unit of compilation in C++. It consists of the content of a single source file, plus the content of any header file directly or indirectly included by it

A single translation unit can be compiled into an object file, library, or executable program

# Compile Process

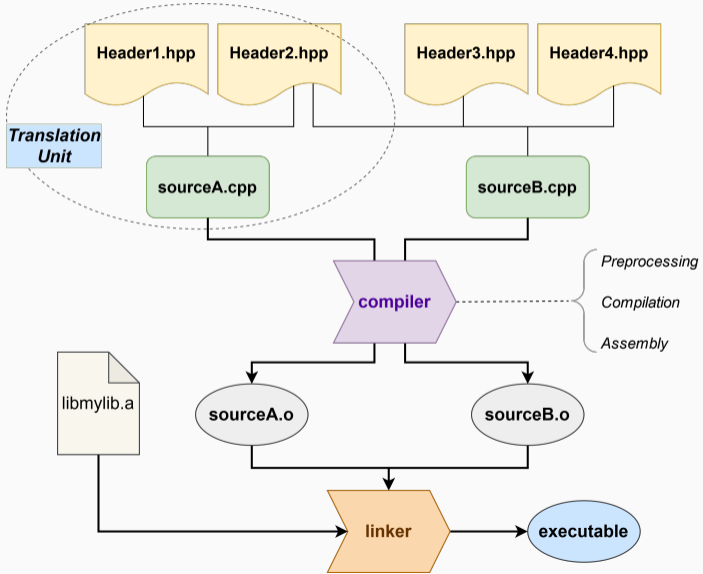



# Local and Global Scope

## Scope

The **scope** of a variable/function/object is the region of the code within the entity can be accessed

## Local Scope / Block Scope

Entities that are declared inside a function or a block are called local variables. Their memory address is not valid outside their scope

## Global Scope / File Scope / Namespace Scope

Entities that are defined outside all functions. They hold a single memory location throughout the life-time of the program

## Local and Global Scope

```
int var1; // global scope

int f() {
 int var2; // local scope
}

struct A {
 int var3; // depends on where the instance of 'A' is used
};
```

# Linkage

## Linkage

**Linkage** refers to the *visibility* of symbols to the linker

## No Linkage

**No linkage** refers to symbols in the local scope of declaration and not visible to the linker

## Internal Linkage

**Internal linkage** refers to symbols visible only in scope of a *single* translation unit. The same symbol name has a different memory address in distinct translation units

## External Linkage

**External linkage** refers to entities that exist ( visible/accessible) *outside* a single translation unit. They are accessible and have the same *identical memory address* through the whole program, which is the combination of all translation units

# Storage Class and Duration

---

## Storage Duration

The **storage duration** (or *duration class*) determines the *duration* of a variable, namely when it is created and destroyed

| Storage Duration | Allocation        | Deallocation        |
|------------------|-------------------|---------------------|
| <b>Automatic</b> | Code block start  | Code block end      |
| <b>Static</b>    | Program start     | Program end         |
| <b>Dynamic</b>   | Memory allocation | Memory deallocation |
| <b>Thread</b>    | Thread start      | Thread end          |

- **Automatic storage duration**. Local variables temporary allocated on registers or stack (depending on compiler, architecture, etc.).  
*If not explicitly initialized, their value is undefined*
- **Static storage duration**. The storage of an object is allocated when the program begins and deallocated when the program ends.  
*If not explicitly initialized, it is zero-initialized*
- **Dynamic storage duration**. The object is allocated and deallocated by using dynamic memory allocation functions ( `new/delete` ).  
*If not explicitly initialized, its memory content is undefined*
- **Thread storage duration** C++11. The object is allocated when the thread begins and deallocated when the thread ends. Each thread has its own instance of the object

# Storage Duration Examples

```
int v1; // static duration

void f() {
 int v2; // automatic duration
 auto v3 = 3; // automatic duration
 auto array = new int[10]; // dynamic duration (allocation)
} // array, v2, v3 variables deallocation (from stack)
 // the memory associated to "array" is not deallocated

int main() {
 f();
}
// main end: v1 is deallocated
```

# Storage Class

## Storage Class Specifier

The **storage class** for a variable declaration is a **type specifier** that, *together with the scope*, governs its *storage duration* and *linkage*

| Storage Class             | Notes                         | Scope  | Storage Duration    | Linkage                       |
|---------------------------|-------------------------------|--------|---------------------|-------------------------------|
| <code>auto</code>         | local <code>var</code> decl.  | Local  | <i>automatic</i>    | <i>No linkage</i>             |
| <i>no storage class</i>   | global <code>var</code> decl. | Global | <i>static</i>       | <i>External</i>               |
| <code>static</code>       |                               | Local  | <i>static</i>       | <i>Function<br/>Dependent</i> |
| <code>static</code>       |                               | Global | <i>static</i>       | <i>Internal</i>               |
| <code>extern</code>       |                               | Global | <i>static</i>       | <i>External</i>               |
| <code>thread_local</code> | <b>C++11</b>                  | any    | <i>thread local</i> | <i>any</i>                    |



# Storage Class Examples

```
int v1; // no storage class
static int v2 = 2; // static storage class
extern int v3; // external storage class
thread_local int v4; // thread local storage class
thread_local static int v5; // thread local and static storage classes

int main() {
 int v6; // auto storage class
 auto v7 = 3; // auto storage class
 static int v8; // static storage class
 thread_local int v9; // thread local and auto storage classes
 auto array = new int[10]; // auto storage class ("array" variable)
}
```

## static Keyword for Local Variables

`static` *local variables* are allocated when the program begins, *initialized* when the function is called the first time, and deallocated when the program ends

```
int f() {
 static int val = 1;
 val++;
 return val;
}

int main() {
 cout << f(); // print 2 ("val" is initialized)
 cout << f(); // print 3
 cout << f(); // print 4
}
```

## static Keyword for Global Variables

`static` *global variables* or *functions* are visible only within the translation unit where they are declared → *internal linkage*

- **Non-`static`** *global variables* or *functions* with the same name in different translation units produce *name collision* (or name conflict) → multiple definitions at link-time

```
int var1 = 3; // external linkage
 // (in conflict with variables in other
 // translation units with the same name)

static int var2 = 4; // internal linkage (visible only in the
 // current translation unit)

void f1() {} // external linkage (could conflict)

static void f2() {} // internal linkage
```

A namespace with no identifier is called **unnamed/anonymous namespace**

Entities within an anonymous namespace have *internal linkage* and, therefore, are used for declaring unique identifiers, visible only in the same source file

## Anonymous namespace vs. global static functions/variables:

- Entities within an *anonymous namespace* have the same properties of `static` declarations at global scope
- In addition, *anonymous namespaces* allow *type declarations* and *class definitions*
- *Anonymous namespaces* are less verbose than `static` variables/functions but, entities within an *anonymous namespace* are less visible if the scope contains many lines

main.cpp

```
#include <iostream>

namespace { // anonymous, internal linkage

void f() { std::cout << "main"; }

using my_int = int; // not possible
 // with 'static'

} // namespace

int main() {
 f(); // print "main"
}
```

source.cpp

```
#include <iostream>

namespace { // anonymous, internal linkage

void f() { std::cout << "source"; }

using my_int = unsigned; // no conflicts

} // namespace

int g() {
 f(); // print "source", no conflicts
}
```

`extern` keyword is used to declare the existence of *global variables* or *functions* in another translation unit → *external linkage*

- the variable or function must be defined in one and only one translation unit
- it is redundant for functions
- it is necessary for variables to prevent the compiler to associate a memory location in the current translation unit

*Note:* if the same identifier within a translation unit appears with both *internal* and *external* linkage, the behavior is undefined

## External Linkage Example

```
int var1 = 3; // external linkage
 // (in conflict with variables in other
 // translation units with the same name)

extern int var3; // external linkage
 // (implemented in another translation unit)

void f1() {} // external linkage (could conflict)

extern void f4(); // external linkage
 // (implemented in another translation unit)
```

# Linkage of `const` and `constexpr` Variables

---



## Linkage of `const` and `constexpr` Variables

`const` variables have *internal linkage* at global scope

`constexpr` variables imply `const`, which implies *internal linkage*

*note:* the same variable has different memory addresses on different translation units (code bloat)

```
const int var1 = 3; // internal linkage
constexpr int var2 = 2; // internal linkage

static const int var3 = 3; // internal linkage (redundant)
static constexpr int var4 = 2; // internal linkage (redundant)

int main() {}
```

In C++, the order in which global variables are initialized at runtime is not defined. This introduces a subtle problem called *static initialization order fiasco*

source.cpp

```
int f() { return 3; } // run-time function

int x = f(); // run-time evaluation
```

main.cpp

```
extern int x;
int y = x; // run-time initialized

int main() {
 cout << y; // print "3" or "0" depending on the linking order
}
```

source.cpp

```
constexpr int f() { return 3; } // compile-time/run-time function

constexpr int x = f(); // compile-time initialized (C++20)
```

main.cpp

```
constexpr extern int x; // compile-time initialized (C++20)
int y = x; // run-time initialized

int main() {
 cout << y; // print "3"!!
}
```

# Linkage Summary

---

## No Linkage: Local variables, functions, classes

- `static` local variable address depends on the linkage of its function

## Internal Linkage:

(not accessible by other translation units, no conflicts, different memory addresses)

- **Global Variables:**
  - `static`
  - *non-inline, non-template, non-specialized, non-extern* `const` / `constexpr`
- **Functions:** `static`
- Anonymous `namespace` content, even structures/classes

## External Linkage:

(accessible by other translation units, potential conflicts, same memory address)

### ▪ Global Variables:

- no specifier, or `extern`
- `template/specialized` C++14 (no conflicts for `template`, see ODR)
- `inline` `const` / `constexpr` C++17 (no conflicts, see ODR)

### ▪ Functions:

- no specifier (no conflicts with `inline`, see ODR), or `extern`
- `template/specialized` (no conflicts for `template`, see ODR)

Note: `inline`, `constexpr` (which implies `inline` for functions) functions are not accessible by other translation units even with *external linkage*

### ▪ Enumerators, Classes and their *static*, *non-static* members

# Dealing with Multiple Translation Units

---

# Code Structure 1

- one header, two source files → two translation units
- *the header is included in both translation units*

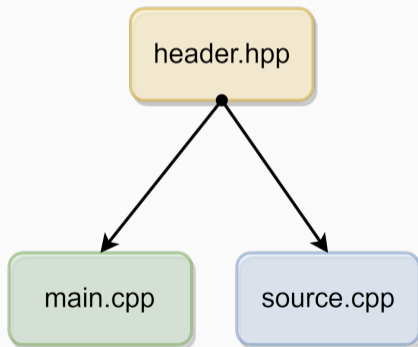



## Code Structure 2

- two headers, two source files → two translation units
- one header for declarations (.hpp), and the other one for implementations (.i.hpp)
- *the header and the header implementation are included in both translation units*

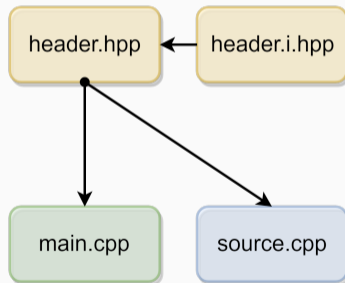

\* separate header declaration and implementation is not mandatory, but it could help to better organize the code

header.hpp:

```
class A {
public:
 void f();
 static void g();
private:
 int x;
 static int y;
};
```

main.cpp:

```
#include "header.hpp"
#include <iostream>

int main() {
 A a;
 std::cout << A.x; // print 1
 std::cout << A.y; // print 2
}
```

source.cpp:

```
#include "header.hpp"

void A::f() {}
void A::g() {}

int A::x = 1;
int A::y = 2;
```

header.hpp:

```
struct A {
 static int y; // zero-init
 // static int y = 3; // compile error
 // must be initialized out-of-class

 const int z = 3; // only in C++11
 // const int z; // compile error
 // must be initialized

 static const int w1; // zero-init
 static const int w2 = 4; // inline-init
};
```

source.cpp:

```
#include "header.hpp"

int A::y = 2;
const int A::w1 = 3;
```

# One Definition Rule (ODR)

---

# One Definition Rule (ODR)

- (1) In any **(single) translation unit**, a template, type, function, or object, *cannot* have more than one definition
  - *Compiler error* otherwise
  - Any number of declarations are allowed
- (2) In the **entire program**, an object or non-inline function *cannot* have more than one definition
  - *Multiple definitions linking error* otherwise
  - Entities with *internal linkage* in different translation units are allowed, even if their names and types are the same
- (3) A template, type, or inline functions/variables, can be defined in more than one translation unit. For a given entity, each definition must be the same
  - *Undefined behavior* otherwise
  - Common case: same header included in multiple translation units

# ODR - Point (1), (2)

header.hpp:

```
void f(); // DECLARATION
```

main.cpp:

```
#include "header.hpp"
#include <iostream>
int a = 1; // external linkage
// int a = 7; // compiler error, Point (1)

extern int b;

static int c = 2; // internal linkage

int main() {
 std::cout << a; // print 1
 std::cout << b; // print 5
 std::cout << c; // print 2
 f();
}
```

source.cpp:

```
#include "header.hpp"
#include <iostream>
// linking error, multiple definitions
// int a = 2; // Point (2)

int b = 5; // ok
// internal linkage
static int c = 4; // ok

void f() { // DEFINITION
 // std::cout << a; // 'a' is not visible
 std::cout << b; // print 5
 std::cout << c; // print 4
}
```

## Global Variable Issues - ODR Point (2)

header.hpp:

```
#include <iostream>
struct A {
 A() { std::cout << "A()"; }
 ~A() { std::cout << "~A()"; }
};
// A obj; // linking error multiple definitions, Point (2)
const A const_obj{}; // "const/constexpr" implies internal linkage
constexpr float PI = 3.14f;
```

source1.cpp:

```
#include "header.hpp"

void f() { std::cout << &PI; }
// address: 0x1234ABCD

// print "A()" the first time
// print "~A()" the first time
```

source2.cpp:

```
#include "header.hpp"

void f() { std::cout << &PI; }
// print address: 0x3820FDAC !!

// print "A()" the second time!!
// print "~A()" the second time!!
```

## Common Class Error - ODR Point (2)

header.hpp:

```
struct A {
 void f() {}; // inline DEFINITION
 void g(); // DECLARATION
 void h(); // DECLARATION
};
void A::g() {} // DEFINITION
```

main.cpp:

```
#include "header.hpp"
// linking error
// multiple definitions of A::g()

int main() {}
```

source.cpp:

```
#include "header.hpp"
// linking error
// multiple definitions of A::g()

void A::h() {} // DEFINITION, ok
```



## ODR - Point (3)

**ODR Point (3):** A template, type, or inline functions/variables, can be defined in more than one translation unit

- The linker removes all definitions of an `inline / template` entity except one
- All definitions must be identical to avoid undefined behavior due to arbitrary linking order
- `inline / template` entities have a *unique memory address* across all translation units
- `inline / template` entities have the *same linkage* as the corresponding variables/functions without the specifier

**inline**

`inline` specifier allows a function or a variable (in C++17) to be identically defined (not only declared) in multiple translation units

- `inline` is one of the most misunderstood features of C++
- `inline` is a hint for the linker. Without it, the linker can emit “multiple definitions” error
- `inline` entities cannot be *exported*, namely, used by other translation units even if they have *external linkage* (related warning: `-Wundefined-inline`)
- `inline` doesn't mean that the compiler is forced to perform function *inlining*. It just increases the optimization heuristic threshold

```
void f() {}
inline void g() {}
```

f() :

- Cannot be defined in a header included in multiple source files
- The linker issues a “*multiple definitions*” error

g() :

- Can be defined in a header and included in multiple source files

## constexpr and inline

`constexpr` functions are implicitly `inline`

`constexpr` variables are not implicitly `inline`. C++17 added `inline` variables

```
void f1() {} // external linkage
 // potential multiple definitions error

constexpr void f2() {} // external linkage, implicitly inline
 // multiple definitions allowed

constexpr int x = 3; // internal linkage
 // different files allows distinct definitions
 // -> different addresses, code bloat

inline constexpr int y = 3; // external linkage unique memory address
 // -> potential undefined behavior

int main() {}
```

header.hpp:

```
inline void f() {} // the function is marked 'inline' (no linking error)
inline int v = 3; // the variable is marked 'inline' (no linking error) (C++17)

template<typename T>
void g(T x) {} // the function is a template (no linking error)

using var_t = int; // types can be defined multiple times (no linking error)
```

main.cpp:

```
#include "header.hpp"

int main() {
 f();
 g(3); // g<int> generated
}
```

source.cpp:

```
#include "header.hpp"

void h() {
 f();
 g(5); // g<int> generated
}
```

## Alternative organization:

header.hpp:

```
inline void f(); // DECLARATION
inline int v; // DECLARATION

template<typename T>
void g(T x); // DECLARATION

using var_t = int; // type
#include "header.i.hpp"
```

header.i.hpp:

```
void f() {} // DEFINITION
int v = 3; // DEFINITION

template<typename T>
void g(T x) {} // DEFINITION
```

main.cpp:

```
#include "header.hpp"

int main() {
 f();
 g(3); // g<int> generated
}
```

source.cpp:

```
#include "header.hpp"

void h() {
 f();
 g(5); // g<int> generated
}
```

# ODR - Function Template

---

# Function Template - Case 1

header.hpp:

```
template<typename T>
void f(T x) {}; // DECLARATION and DEFINITION
```

main.cpp:

```
#include "header.hpp"

int main() {
 f(3); // call f<int>()
 f(3.3f); // call f<float>()
 f('a'); // call f<char>()
}
```

source.cpp:

```
#include "header.hpp"

void h() {
 f(3); // call f<int>()
 f(3.3f); // call f<float>()
 f('a'); // call f<char>()
}
```

`f<int>()`, `f<float>()`, `f<char>()` are generated two times (in both translation units)



## Function Template - Case 2

header.hpp:

```
template<typename T>
void f(T x); // DECLARATION
```

main.cpp:

```
#include "header.hpp"

int main() {
 f(3); // call f<int>()
 f(3.3f); // call f<float>()
 // f('a'); // linking error
} // the specialization does not exist
```

source.cpp:

```
#include "header.hpp"

template<typename T>
void f(T x) {} // DEFINITION

// template SPECIALIZATION
template void f<int>(int);
template void f<float>(float);
// any explicit instance is also
// fine, e.g. f<int>(3)
```

# Function Template and Specialization

header.hpp:

```
template<typename T>
void f() {} // DECLARATION and DEFINITION
```

main.cpp:

```
#include "header.hpp"

int main() {
 f<char>(); // use the generic function
 f<int>(); // use the specialization
}
```

source.cpp:

```
#include "header.hpp"

template<>
void f<int>() {} // SPECIALIZATION
 // DEFINITION
```

# Function Template - extern Keyword

C++11

header.hpp:

```
template<typename T>
void f() {} // DECLARATION and DEFINITION
```

main.cpp:

```
#include "header.hpp"

extern template void f<int>();
// f<int>() is not generated by the
// compiler in this translation unit

int main() {
 f<int>();
}
```

source.cpp:

```
#include "header.hpp"

void g() {
 f<int>();
}
// or 'template void f<int>(int);'
```

# ODR Function Template Common Error

header.hpp:

```
template<typename T>
void f(); // DECLARATION

// template<> // linking error
// void f<int>() {} // multiple definitions -> included twice
// full specializations are like standard functions
// it can be solved by adding "inline"
```

main.cpp:

```
#include "header.hpp"

int main() {}
```

source.cpp:

```
#include "header.hpp"

// some code
```

# ODR - Class Template

---

# Class Template - Case 1

header.hpp:

```
template<typename T>
struct A {
 T x = 3; // "inline" DEFINITION
 void f() {}; // "inline" DEFINITION
};
```

main.cpp:

```
#include "header.hpp"

int main() {
 A<int> a1; // ok
 A<float> a2; // ok
 A<char> a3; // ok
}
```

source.cpp:

```
#include "header.hpp"

int g() {
 A<int> a1; // ok
 A<float> a2; // ok
 A<char> a3; // ok
}
```

## Class Template - Case 2

header.hpp:

```
template<typename T>
struct A {
 T x;
 void f(); // DECLARATION
};
#include "header.i.hpp"
```

header.i.hpp:

```
template<typename T>
T A<T>::x = 3; // DEFINITION

template<typename T>
void A<T>::f() {} // DEFINITION
```

main.cpp:

```
#include "header.hpp"

int main() {
 A<int> a1; // ok
 A<float> a2; // ok
 A<char> a3; // ok
}
```

source.cpp:

```
#include "header.hpp"

int g() {
 A<int> a1; // ok
 A<float> a2; // ok
 A<char> a3; // ok
}
```

## Class Template - Case 3

header.hpp:

```
template<typename T>
struct A {
 T x;
 void f(); // DECLARATION
};
```

main.cpp:

```
#include "header.hpp"

int main() {
 A<int> a1; // ok
 // A<char> a2; // linking error
}
// 'f()' is undefined
// while 'x' has an undefined
// value for A<char>
```

source.cpp:

```
#include "header.hpp"

template<typename T>
int A<T>::x = 3; // initialization

template<typename T>
void A<T>::f() {} // DEFINITION

// generate template specialization
template class A<int>;
```



# Class Template - extern Keyword

## C++11

header.hpp:

```
template<typename T>
struct A {
 T x;
 void f() {}
};
```

source.cpp:

```
#include "header.hpp"

extern template class A<int>;
// A<int> is not generated by the
// compiler in this translation unit
int main() {
 A<int> a;
}
```

source.cpp:

```
#include "header.hpp"

// template specialization
template class A<int>;

// or any instantiation of A<int>
```

# **ODR Undefined Behavior and Summary**

---

# Undefined Behavior - inline Function

main.cpp:

```
#include <iostream>
inline int f() { return 3; }

void g();

int main() {
 std::cout << f(); // print 3
 std::cout << g(); // print 3!!
} // not 5
```

source.cpp:

```
// same signature and inline
inline int f() { return 5; }

int g() { return f(); }
```

The linker can *arbitrary* choose one of the two definitions of `f()`. With `-O3`, the compiler could *inline* `f()` in `g()`, so now `g()` return `5`

This issue is easy to detect in trivial examples but hard to find in large codebase

*Solution:* `static` or `anonymous namespace`

# Undefined Behavior - Member Function

header.hpp:

```
#include <iostream>

struct A {
 int f() { return 3; }
};

int g();
```

main.cpp:

```
#include "header.hpp"

int main() {
 A a;
 std::cout << a.f(); // print 3
 std::cout << g(); // print 3!!
}
```

source.cpp:

```
struct A {
 int f() { return 5; }
};

int g() {
 A<int> a;
 return a.f();
}
```

# Undefined Behavior - Function Template

header.hpp:

```
template<typename T>
int f() {
 return 3;
}

int g();
```

main.cpp:

```
#include "header.hpp"

int main() {
 std::cout << f<int>(); // print 3
 std::cout << g(); // print 3!!
}
```

source.cpp:

```
template<typename T>
int f() {
 return 5;
}

int g() {
 return f<int>();
}
```

# Undefined Behavior

Other ODR violations are even harder (if not impossible) to find, see [Diagnosing Hidden ODR Violations in Visual C++](#)

Some tools for partially detecting ODR violations:

- `-detect-odr-violations` flag for gold/llvm linker
- `-Wodr -flto` flag for GCC
- Clang address sanitizer + `ASAN_OPTIONS=detect_odr_violation=2`  
(link)

Another solution could be included all files in a single translation unit

# ODR - Declarations and Definitions Summary

- **Header:** declaration of
  - functions, structures, classes, types, alias
  - `template` functions, structs, classes
  - `extern` variables, functions
- **Header (implementation):** definition of
  - `inline` variables/functions
  - `template` variables/functions/classes
  - global *static*, *non-static* `const/constexpr` variables and `constexpr` functions
- **Source file:** definition of
  - functions, including `template` full specializations
  - classes
  - `extern` and `static` global variables/functions

# Modern C++ Programming

## 12. TRANSLATION UNITS II

INCLUDE, MODULE, AND COMPILATION

---

*Federico Busato*

2024-11-05



## **1** #include Issues

- Include Guard
- Forward Declaration
- Circular Dependencies
- Common Linking Errors

## 2 C++20 Modules

- Overview
- Terminology
- Visibility and Reachability
- Module Unit Types
- Keywords
- Global Module Fragment
- Private Module Fragment
- Header Module Unit
- Module Partitions

## **3** Compiling Multiple Translation Units

- Fundamental Compiler Flags
- Compile Methods

## 4 Libraries in C++

- Static Library
- Building Static Libraries
- Using Static Libraries
- Dynamic Library
- Building Dynamic Libraries
- Using Dynamic Libraries
- Application Binary Interface (ABI)
- Demangling
- Find Dynamic Library Dependencies
- Analyze Object/Executable Symbols

# #include Issues

---

The `include guard` avoids the problem of multiple inclusions of a header file in a translation unit

`header.hpp`:

```
#ifndef HEADER_HPP // include guard
#define HEADER_HPP

... many lines of code ...

#endif // HEADER_HPP
```

`#pragma once` preprocessor directive is an alternative to the `include guard` to force current file to be included only once in a translation unit

- `#pragma once` is less portable but less verbose and compile faster than the `include guard`

The `include guard`/`#pragma once` should be used in every header file

Common case:

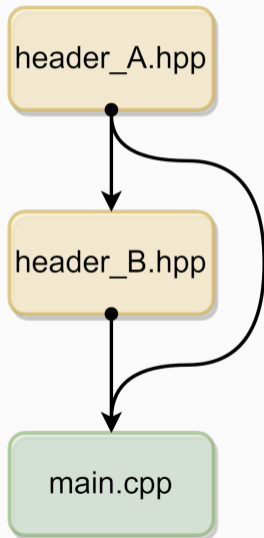

header\_A.hpp:

```
#pragma once // prevent "multiple definitions" linking error

struct A {
};
```

header\_B.hpp:

```
#include "header_A.hpp" // included here

struct B {
 A a;
};
```

main.cpp:

```
#include "header_A.hpp" // .. and included here
#include "header_B.hpp"
int main() {
 A a; // ok, here we need "header_A.hpp"
 B b; // ok, here we need "header_B.hpp"
}
```



# Forward Declaration

**Forward declaration** is a declaration of an identifier for which a complete definition has not yet given. “*forward*” means that an entity is declared before it is defined

```
void f(); // function forward declaration

class A; // class forward declaration

int main() {
 f(); // ok, f() is defined in the translation unit
 // A a; // compiler error no definition (incomplete type)
 // e.g. the compiler is not able to deduce the size of A
 A* a; // ok
}

void f() {} // definition of f()
class A {}; // definition of A()
```

# Forward Declaration vs. #include

## Advantages:

- Forward declarations can save compile time as `#include` forces the compiler to open more files and process more input
- Forward declarations can save on unnecessary recompilation. `#include` can force your code to be recompiled more often, due to unrelated changes in the header

## Disadvantages:

- Forward declarations can hide a dependency, allowing user code to skip necessary recompilation when headers change
- A forward declaration may be broken by subsequent changes to the library
- Forward declaring multiple symbols from a header can be more verbose than simply `#including` the header

A **circular dependency** is a relation between two or more modules which either directly or indirectly depend on each other to function properly

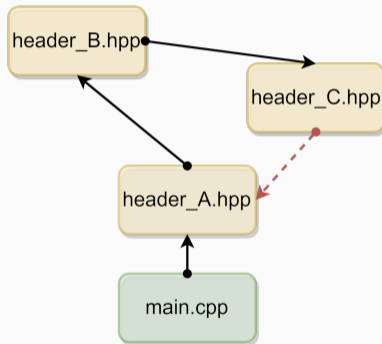

Circular dependencies can be solved by using forward declaration, or better, by rethinking the project organization

header\_A.hpp:

```
#pragma once // first include
#include "header_B.hpp"
class A {
 B* b;
};
```

header\_B.hpp:

```
#pragma once // second include
#include "header_C.hpp"
class B {
 C* c;
};
```

header\_C.hpp:

```
#pragma once // third include
#include "header_A.hpp"
class C { // compile error "header_A.hpp": already included by "main.cpp"
 A* a; // the compiler does not know the meaning of "A"
};
```

header\_A.hpp:

```
#pragma once
class B; // forward declaration
 // note: does not include "header_B.hpp"

class A {
 B* b;
};
```

header\_B.hpp:

```
#pragma once
class C; // forward declaration
class B {
 C* c;
};
```

header\_C.hpp:

```
#pragma once
class A; // forward declaration
class C {
 A* a;
};
```

# Common Linking Errors

Very common *linking* errors:

- **undefined reference**

*Solutions:*

- Check if the right headers and sources are included
- Break circular dependencies (could be hard to find)

- **multiple definitions**

*Solutions:*

- **inline** function, variable definition or **extern** declaration
- Add include guard/ **#pragma once** to header files
- Place template definition in header file and full specialization in source files

# C++20 Modules

---

**The `#include` problem:** *The duplication of work* - the same header files are possibly parsed/compiled multiple times and most of the compiled output is later-on thrown away again by the linker

C++20 introduces **modules** as a robust replacement for plain `#include`

### Module (C++20)

A **module** is a set of source code files that are compiled independently of the translation units that import them

**Modules** allow defining clearer interfaces with a fine-grained control on what to *import* and *export* (similar to Java, Python, Rust, etc.)

- 
- A Practical Introduction to C++20's Modules
  - Modules the beginner's guide
  - Understanding C++ Modules
  - Overview of modules in C++



*Less error-prone than* `#include` :

- No effect on the compilation of the translation unit that *imports* the module
- Macros, preprocessor directives, and *non-exported* names declared in a module are not visible outside the module
- Declarations in the *importing* translation unit do not participate in overload resolution or name lookup in the *imported* module

Other benefits:

- **(Much) Faster compile time.** After a module is compiled once, the results are stored in a binary file that describes all the exported types, functions, and templates
- **Smaller binary size.** Allow to incorporate only the imported code and not the whole `#include`

# Terminology

A **module** consists of one or more **module units**

A **module unit** is a *translation unit* that contains a **module** declaration

```
module my.module.example;
```

A **module name** is a concatenation of *identifiers* joined by dots (the dot carries no meaning) `my.module.example`

A **module unit purview** is the content of the translation unit

A **module purview** is the set of **purviews** of a given *module name*

**Visibility** of **names** instructs the linker if a symbol can be used by another translation unit. *Visible* also means *a candidate for name lookup*

**Reachable** of **declarations** means that the semantic properties of an entity are available

- Each *visible* declaration is also *reachable*
- Not all *reachable* declarations are also *visible*

## Reachability Example

*Common example:* the members of a class are reachable (i.e. can be used) or the class size is known, but not the class type itself

```
auto g() {
 struct A {
 void f() {}
 };
 return A{};
}
//-----

auto x = g(); // ok
// A y = g(); // compile error, "A" is unknown at this point
x.f(); // ok
sizeof(x); // ok
using T = decltype(x); // ok
```

## Module Unit Types

- A **module interface unit** is a *module unit* that exports a symbol and/or *module name* or *module partition name*
- A **primary module interface unit** is a *module interface unit* that exports the *module name*. There must be one and only one *primary module interface unit* in a module
- A **module implementation unit** is a *module unit* that does not export a *module name* or *module partition name*

A **module interface unit** should contain only declarations if one or more *module implementation units* are present. A **module implementation unit** implements/defines the declarations of *module interface units*

# Keywords

`module` specifies that the file is a *named module*

```
module my.module; // first code line
```

`import` makes a module and its symbols visible in the current file

```
import my.module; // after module declaration and #include
```

`export` makes symbols visible to the files that `import` the current module

- `export module <module_name>` makes visible all the exported symbols of a module. It must appear once per module in the *primary module interface unit*
- `export namespace <namespace>` makes visible all symbols in a namespace
- `export <entity>` makes visible a specific function, class, or variable
- `export {<code>}` makes visible all symbols in a block

## import Example

```
#include <iostream>

int main() {
 std::cout << "Hello World";
}
```

Preprocessing size -E: ~1MB

```
import <iostream>;

int main() {
 std::cout << "Hello World";
}
```

Preprocessing size: 236B (x500)

Compile time: 2x (up to 10x) less

```
g++-12 -std=c++20 -fmodules-ts main.cpp -x c++-system-header iostream
```

## export Example - Single Primary Module Interface Unit

my\_module.cpp

```
export module my.example; // make visible all module symbols

export int f1() { return 3; } // export function

export namespace my_ns { // export namespace and its content
int f2() { return 5; }
}

export { // export code block
int f3() { return 2; }
int f4() { return 8; }
}

void internal() {} // NOT exported. It can be used only internally
```



## export Example - Two Module Interface Units

my\_module1.cpp *Primary Module Interface Unit*

```
export module my.example; // This is the only file that exports all module symbols

export int f1() { return 3; } // export function
```

my\_module2.cpp *Module Interface Unit*

```
module my.example; // Module declaration but symbols are not exported

export namespace my_ns { // export namespace
int f2() { return 5; }
}

export { // export code block7
int f3() { return 2; }
int f4() { return 8; }
}
```

## export Example - Module Interface and Implementation Units

my\_module1.cpp *Primary Module Interface Unit*

```
export module my.example; // This is the only file that exports all module symbols

export int f1(); // export function

export { // export code block
int f3();
int f4();
}
```

my\_module2.cpp *Module Implementation Unit*

```
module my.example; // Module declaration but symbols are not exported

int f1() { return 3; }
int f3() { return 2; }
int f4() { return 8; }
```

## import

- A **module implementation unit** can **import** another module, but cannot **export** any names. Symbols of the *module interface unit* are imported implicitly
- All **import** must appear before any declarations in that module unit and after **module;** a **export module** (if present)

## export

- Symbols with *internal linkage* or *no linkage* cannot be exported, i.e. anonymous namespaces and **static** entities
- The **export** keyword is used in **module interface units** only
- The semantic properties associated to **exported** symbols become *reachable*

## export import Declaration

*Imported modules* can be directly **re-exported**

```
export module main_module; // Top-level primary module interface unit
```

```
export import sub_module; // import and re-export "sub_module"
```

```
export module sub_module; // Primary module interface unit
```

```
export void f() {}
```

```
import main_module;
```

```
int main() {
 f(); // ok, f() is visible
}
```

## Global Module Fragment

A **global module fragment** (*unnamed module*) can be used to *include header files* in a *module interface* when importing them is not possible or preprocessing directives are needed

```
module; // start Global Module Fragment

#define ENABLE_FAST_MATH
#include "my_math.h"

export modul my.module; // end Global Module Fragment
```

Macro definitions or other preprocessing directives are not visible outside the file itself

## Private Module Fragment

A **private module fragment** allows a module to be represented as a single translation unit without making all the contents of the module reachable to importers

→ A modification of the *private module fragment* does not cause recompilation

If a module unit contains a *private module fragment*, it will be the only module unit of its module

```
export module my.example;
export int f();

module :private; // start private module fragment

int f() { // definition not reachable from importers of f()
 return 42;
}
```

*Legacy headers* can be directly imported with `import` instead of `#include`

All declarations are implicitly exported and attached to the **global module (fragment)**

- Macros from the header are available for the *importer*, but macros defined in the *importer* have no effect on the *imported header*
- Importing compiled declarations is faster than `#include`

C++23 will introduce modules for the standard library

A *module* can be organized in *isolated* **module partitions**

*Syntax:*

```
export module module_name : partition_name;
```

- *Declarations* in any of the **partitions** are visible within the entire module
- Like common modules, a *module partition* consists in one **module partition interface unit** and zero or more **module partition implementation units**
- *Module partitions* are not visible outside the module
- *Module partitions* do not implicitly import the module interface
- All names exported by *partition interface* files must be imported and re-exported by the *primary module interface file*



main\_module.ixx

```
export module main_module;

export import :partition1; // re-export f() to importers of "main_module"
export import :partition2; // re-export g() to importers of "main_module"

export void h() { internal(); } // internal() can be directly used
```

partition1.ixx

```
export module module_name:partition1;

export void f() {}
```

partition2.ixx

```
export module module_name:partition2;

export void g() {}
void internal() {} // not exported
```

# Compiling Multiple Translation Units

---

# Fundamental Compiler Flags

Include flag: `g++ -I include/ main.cpp -o main.x`

- `-I`: Specify the **include path** for the project headers
- `-isystem`: Specify the **include path** for system (external) headers (warnings are not emitted)

They can be used multiple times

*Important:* *include* and *library* compiler flags, as well as multiple values in an environment variable, are evaluated in order from left to right. The first match suppress the other ones

Compile to a file object: `g++ -c source.cpp -o source.o`

# Compile Methods

## Method 1

Compile all files together (naive):

```
g++ main.cpp source.cpp -o main.out
```

## Method 2

Compile each *translation unit* in a file object:

```
g++ -c source.cpp -o source.o
```

```
g++ -c main.cpp -o main.o
```

Multiple objects can be compiled in parallel

Link all file objects:

```
g++ main.o source.o -o main.out
```

# Libraries in C++

---

## Static Library

A **static library** is a set of object files (just the concatenation) that are directly linked into the final executable. If a program is compiled with a static library, all the functionality of the static library becomes part of final executable

- A static library cannot be modified without re-link the final executable
- Increase the size of the final executable
- + The linker can optimize the final executable (*link time optimization*)

Given the static library `my_lib`, the corresponding file is:

Linux `libmy_lib.a`

Windows `my_lib.lib`

## Steps to build a static library

- Compile object files for each translation unit (.cpp)
- Create the static library by using the **archiver (ar)** Linux utility

```
g++ source1.c -c source1.o
g++ source2.c -c source2.o
ar rvs libmystaticlib.a source1.o source2.o
```

## Using Static Libraries

A *static library* has to be **linked** to the final executable:

```
Linux g++ -llibrary main.cpp -o main
```

```
Windows msvc <path_to_library>/library.lib main.cpp /OUT:main.exe
```

The directories where to search for *static* libraries at *compile-time* are specified with environment variables:

```
Linux LIBRARY_PATH Search for .a files
```

```
Windows LIBPATH Search for .lib files
```

It is also possible to specify additional *library paths* with compiler flags:

```
Linux g++ -L<library_path> main.cpp -o main
```

```
Windows msvc /LIBPATH<library_path> main.cpp /OUT:main.exe
```



# Dynamic Library

A **dynamic library**, also called a **shared library**, consists of routines that are loaded into the application at run-time. If a program is compiled with a dynamic library, the library does not become part of final executable. It remains as a separate unit

- + A dynamic library can be modified without re-link: bug fixing, new functionalities
- Dynamic library functions are called outside the executable. Neither the linker nor the compiler can optimize the code between shared libraries and the final executable
  - The environment variables must be set to the right shared library path, otherwise the application crashes at the beginning

Given the shared library `my_lib`, the corresponding file is:

Linux `libmy_lib.so`

Windows `my_lib.dll` + `my_lib.lib`

## Steps to build a dynamic library

- Compile object files for each translation unit (.cpp). Since library cannot store code at fixed addresses, the compiler must generate *position independent code* (-fPIC)
- Create the dynamic library

```
g++ source1.c -c source1.o -fPIC
g++ source2.c -c source2.o -fPIC
g++ source1.o source2.o -shared -o libmydynamiclib.so
```

## Using Dynamic Libraries

*Dynamic libraries* need to be available when the program executes (*run-time*). The program searches for dynamic libraries in the same directory and the paths specified in the following environment variables:

Linux `LD_LIBRARY_PATH` Search for `.so` files

Windows `PATH` Search for `.dll`

# Application Binary Interface (ABI)

An **Application Binary Interface (ABI)** defines the low-level details of how programs composed of separately compiled modules work together. An ABI specifies how functions are called and how data is exchanged.

A **stable ABI** is essential to update the program's shared libraries without recompiling all the code

Some examples of ABI-breaking changes are changing the type or order of members within a `struct`, modifying the return type or parameters of a function, or adding a `virtual` function to a class that previously did not have one

An ABI can be also checked across different shared library/header versions with specific tools, such as [ABI Compliance Checker](#) 

# Demangling

**Name mangling** is a technique used to solve various problems caused by the need to resolve unique names

Transforming C++ ABI (Application binary interface) identifiers into the original source identifiers is called **demangling**

Example (linking error):

```
_ZNSt13basic_filebufIcSt11char_traitsIcEED1Ev
```

After demangling:

```
std::basic_filebuf<char, std::char_traits<char> >::~~basic_filebuf()
```

**How to demangle:** `echo <name> | c++filt`

Online Demangler: <https://demangler.com>

## Find Dynamic Library Dependencies

The `ldd` utility shows the shared objects (shared libraries) required by a program or other shared objects

```
$ ldd /bin/ls
linux-vdso.so.1 (0x00007ffcc3563000)
libselinux.so.1 => /lib64/libselinux.so.1 (0x00007f87e5459000)
libcap.so.2 => /lib64/libcap.so.2 (0x00007f87e5254000)
libc.so.6 => /lib64/libc.so.6 (0x00007f87e4e92000)
libpcre.so.1 => /lib64/libpcre.so.1 (0x00007f87e4c22000)
libdl.so.2 => /lib64/libdl.so.2 (0x00007f87e4a1e000)
/lib64/ld-linux-x86-64.so.2 (0x00005574bf12e000)
libattr.so.1 => /lib64/libattr.so.1 (0x00007f87e4817000)
libpthread.so.0 => /lib64/libpthread.so.0 (0x00007f87e45fa000)
```

The `nm` utility provides information on the symbols being used in an object file or executable file

```
$ nm -D -C something.so
w __gmon_start__
D __libc_start_main
D free
D malloc
D printf
```

*# -C: Decode low-level symbol names*

*# -D: accepts a dynamic library*

`readelf` displays information about ELF format object files

```
$ readelf --symbols something.so | c++filt
... OBJECT LOCAL DEFAULT 17 __frame_dummy_init_array_
... FILE LOCAL DEFAULT ABS prog.cpp
... OBJECT LOCAL DEFAULT 14 CC1
... OBJECT LOCAL DEFAULT 14 CC2
... FUNC LOCAL DEFAULT 12 g()
```

*# --symbols: display symbol table*



`objdump` displays information about object files

```
$ objdump -t -C something.so | c++filt
... df *ABS* ... prog.cpp
... 0 .rodata ... CC1
... 0 .rodata ... CC2
... F .text ... g()
... 0 .rodata ... (anonymous namespace)::CC3
... 0 .rodata ... (anonymous namespace)::CC4
... F .text ... (anonymous namespace)::h()
... F .text ... (anonymous namespace)::B::j1()
... F .text ... (anonymous namespace)::B::j2()
```

*# --t: display symbols*

*# -C: Decode low-level symbol names*

## References and Additional Material

- 20 ABI (Application Binary Interface) breaking changes every C++ developer should know
- Policies/Binary Compatibility Issues With C++
- 10 differences between static and dynamic libraries every C++ developer should know

# Modern C++ Programming

## 13. CODE CONVENTIONS

### PART I

---

*Federico Busato*

2024-11-05

## **1** C++ Project Organization

- Project Directories
- Project Files
- “Common” Project Organization Notes
- Alternative - “Canonical” Project Organization

## **2** Coding Styles and Conventions

- Overview
- Popular Coding Styles

## 3 Header Files and #include

- #include Guard
- #include Syntax
- Order of #include
- Common Header/Source Filename Conventions

## 4 Preprocessing

- Macro
- Preprocessing Statements

## 5 Variables

- `static` Global Variables
- Conversions

## 6 Enumerators

## 7 Arithmetic Types

- Signed vs. Unsigned Integral Types
- Integral Types Conversion
- Integral Types: Size and Other Issues
- Floating-Point Types

## **8** Functions

- Functions Parameters
- Functions Arguments
- Function Return Values
- Function Specifiers
- Lambda Expressions

## 9 Structs and Classes

- `struct` vs. `class`
- Initialization
- Braced Initializer Lists
- Special Member Functions
- `=default`, `=delete`
- Other Issues
- Inheritance
- Style



# C++ Project Organization

---

# “Common” Project Organization

Project  
Root



bin



build



doc



submodules



third\_party



data



test



examples



utils



include



src



LICENSE



README.md



CMakeLists.txt



Doxyfile



.gitignore



.clang-tidy



.clang-format

## Fundamental directories

`include` Project *public* header files

`src` Project source/implementation files and *private* headers

`test` (or `tests`) Source files for testing the project

## Empty directories

`bin` Output executables

`build` All intermediate files

`doc` (or `docs`) Project documentation

## Optional directories

`submodules` Project submodules

`third_party` (less often `deps/external/extern`) dependencies or external libraries

`data` (or `extras`) Files used by the executables or for testing

`examples` Source files for showing project features

`utils` (or `tools`, or `script`) Scripts and utilities related to the project

`cmake` CMake submodules (`.cmake`)

## Project Files

`LICENSE` Describes how this project can be used and distributed

`README.md` General information about the project in Markdown format \*

`CMakeLists.txt` Describes how to compile the project

`Doxyfile` Configuration file used by doxygen to generate the documentation (see next lecture)

*others* `.gitignore`, `.clang-format`, `.clang-tidy`, etc.

---

\* Markdown is a language with a syntax corresponding to a subset of HTML tags  
[github.com/adam-p/markdown-here/wiki/Markdown-Cheatsheet](https://github.com/adam-p/markdown-here/wiki/Markdown-Cheatsheet)

## README.md

- README template:
  - Embedded Artistry README Template
  - Your Project is Great, So Let's Make Your README Great Too

## LICENSE

- Choose an open source license:  
`choosealicense.com`
- License guidelines:  
`Why your academic code needs a software license`

## Common C++ file extensions:

- **header** `.h` `.hh` `.hpp` `.hxx`
- **header implementation** `.i.h` `.i.hpp` `-inl.h` `.inl.hpp`
  - (1) separate implementation from interface for inline functions and templates
  - (2) keep implementation “inline” in the header file
- **source/implementation** `.c` `.cc` `.cpp` `.cxx`

## “Common” Project Organization Notes

- Public **header(s)** in `include/`
- **source files**, private **headers**, **header implementations** in `src/` directory
- The **main** file (if present) should be placed in `src/` and called `main.cpp`
- **Code tests**, *unit* and *functional* tests can be placed in `test/`.  
Alternatively, **unit tests** can appear in the same directory of the component under test with the same filename and include `.test` suffix, e.g.  
`my_file.test.cpp`



## “Common” Project Organization Example

<project\_name>

include/

public\_header.hpp

src/

private\_header.hpp

templ\_class.hpp

templ\_class.i.hpp

(template/inline functions)

templ\_class.cpp

(specialization)

subdir/

my\_file.cpp

README.md

CMakeLists.txt

Doxyfile

LICENSE

build/ (empty)

bin/ (empty)

doc/ (empty)

test/

my\_test.hpp

my\_test.cpp

...

## “Common” Project Organization - Improvements

The “common” project organization can be improved by adding the *name of the project* as subdirectory of `include/`

Some projects often entirely avoid the `include/` directory

This is particularly useful when the project is used as *submodule* (part of a larger project) or imported as an *external library*

The includes now look like:

```
#include <my_project/public_header.hpp>
```



- *Header and source files* (or *module interface and implementation files*) are next to each other (no `include/` and `src/` split)
- *Headers* are included with `<>` and contain the project directory prefix, for example, `<hello/hello.hpp>` (no need of `""` syntax)
- *Header and source file extensions* are `.hpp` / `.cpp` (`.mpp` for module interfaces). No special characters other than `_` and `-` in file names with `.` only used for extensions
- A source file that implements a *module's unit tests* should be placed next to that *module's files* and be called with the module's name plus the `.test` second-level extension
- A project's functional/integration tests should go into the `test/` subdirectory

```
<project_name> (v1)
├── <project_name>/
│ ├── public_header.hpp
│ ├── private_header.hpp
│ ├── my_file.cpp
│ ├── my_file.mpp
│ └── my_file.test.cpp
├── test/
│ └── my_functional_test.cpp
├── build/
├── doc/
└── ...
```

```
<project_name> (v2)
├── <project_name>/
│ ├── public_header.hpp
│ └── private/
│ ├── private_header.hpp
│ ├── my_internal_file.cpp
│ └── my_internal_file.test.cpp
├── test/
│ └── my_functional_test.cpp
├── build/
├── doc/
└── ...
```

- `Kick-start your C++!` A template for modern C++ projects
- `The Pitchfork Layout`
- `Canonical Project Structure`

# Coding Styles and Conventions

---

*“One thing people should remember is there is what you can do in a language and what you should do”*

**Bjarne Stroustrup**

Most important rule:

**BE CONSISTENT!!**

“The best code explains itself”

GOOGLE



*“80% of the lifetime cost of a piece of software goes to maintenance”*

**Unreal Engine**

“The worst thing that can happen to a code base is size”

— Steve Yegge

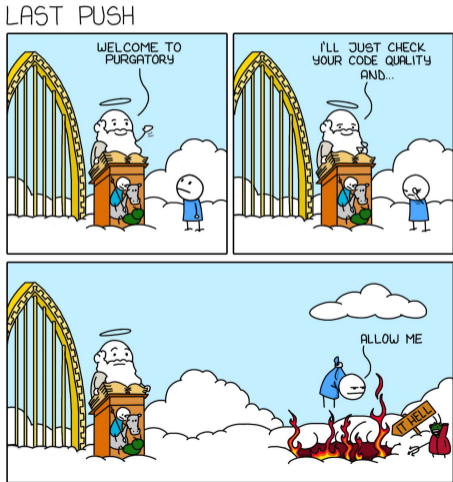

# Bad Code

How *my* code looks like for other people?

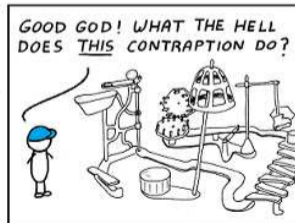
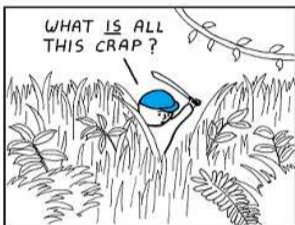
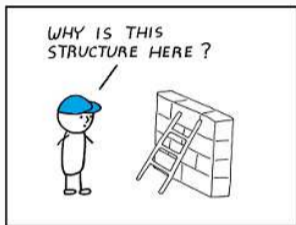

# Coding Styles Overview

**Coding styles** are common guidelines to improve the *readability*, *maintainability*, prevent *common errors*, and make the code more *uniform*

A **consistent code** base helps developers better understand code organization, focus on program logic, and reduce the time spent interpreting other engineers' intentions

PERSONAL COMMENT: Don't start a project that involves multiple engineers without establishing clear guidelines that all engineers agree to. This is essential to avoid costly refactoring, personal style discussions, and conflicts later on

This section, including the review of all coding styles, has been updated on October 2024

- **LLVM Coding Standards.** [llvm.org/docs/CodingStandards.html](http://llvm.org/docs/CodingStandards.html) ↗
- **Google C++ Style Guide.**  
[google.github.io/styleguide/cppguide.html](https://google.github.io/styleguide/cppguide.html) ↗
- **Webkit Coding Style.** [webkit.org/code-style-guidelines](http://webkit.org/code-style-guidelines) ↗
- **Mozilla Coding Style.** [firefox-source-docs.mozilla.org](http://firefox-source-docs.mozilla.org) ↗  
The Firefox code base adopts parts of the Google Coding style for C++ code (C++17, 2020), but not all of its rules
- **Chromium Coding Style.** [chromium.googlesource.com](http://chromium.googlesource.com) ↗  
Chromium follows the Google C++ Style Guide with some exceptions

- ***Unreal Engine - Coding Standard***

`docs.unrealengine.com/en-us/Programming` ↗

- ***μOS++*** (derived from MISRA 2018 and JSV)

`micro-os-plus.github.io/develop/coding-style` ↗

`micro-os-plus.github.io/develop/naming-conventions` ↗

*More educational-oriented guidelines*

- ***C++ Core Guidelines***

`isocpp.github.io/CppCoreGuidelines/CppCoreGuidelines` ↗

## Secure Coding

- **High Integrity C++ Coding Standard.** [www.perforce.com/resources](http://www.perforce.com/resources)
- **CERT C++ Secure Coding.** [wiki.sei.cmu.edu](http://wiki.sei.cmu.edu)

## Critical system coding standards

- **MISRA C++17, 2023.** [www.misra.org.uk](http://www.misra.org.uk)
- **Autosar C++14, 2019** (based on MISRA:2008). [www.autosar.org](http://www.autosar.org)
- **Joint Strike Fighter Air Vehicle (JSV) C++, 2005.** JSF-AV-rule

## Static Analysis Tools

- ***clang-tidy***

`clang.llvm.org/extra/clang-tidy/checks/list.html` ↗

- ***PVS-Studio***

`pvs-studio.com/en/docs/warnings` ↗

- ***SonarSource***

`rules.sonarsource.com/cpp/` ↗

- ***cpp-checks***

`sourceforge.net/p/cppcheck/wiki/ListOfChecks/` ↗

*Note:* each tool also provides the list of checks that are evaluated



# Legend

- ※ → **Important!**

Highlight potential code issues such as bugs, inefficiency, or important readability problems. Should not be ignored

- \* → **Useful**

It is not fundamental, but it emphasizes good practices and can help to prevent bugs. Should be followed if possible

- → **Minor / Obvious**

Style choice, not very common issue, or hard to enforce

# Header Files and `#include`

---

## ※ Every include must be self-contained

- include every header you need directly
- do not rely on recursive `#include`
- the project must compile with any include order

LLVM, GOOGLE, UNREAL, μOS, CORECPP

## \* Include as less as possible, especially in header files

- do not include unneeded headers
- minimize dependencies
- minimize code in headers (e.g. use forward declarations)

LLVM, GOOGLE, CHROMIUM, UNREAL, HIC, μOS, MOZILLA, CLANG-TIDY,  
CORECPP

## \* Every source file should have an associated header file GOOGLE, CORECPP.29/76

\* `#include` preprocessor should be placed immediately after the header comment and include guard [LLVM](#), [μOS](#), [CORECPP](#)

\* **Use C++ headers instead of C headers.** C++ headers define additional functions and their symbols are in the `std` namespace [HIC](#)

`<cassert>` instead of `<assert.h>`  
`<cmath>` instead of `<math.h>`, etc.

# #include Guard

## ※ Always use an include guard

LLVM, GOOGLE, CHROMIUM, UNREAL, CORECPP

### ▪ macro include guard vs. #pragma once

- Use macro include guard if portability is a very strong requirement

LLVM, GOOGLE, CHROMIUM, CORECPP, MOZILLA, HIC

- #pragma once otherwise

WEBKIT, UNREAL

## ※ Ensure a unique name for the include guard, e.g. project\_name + path

GOOGLEq

# #include Syntax

## "" syntax

- \* Should be absolute paths from the project include root [GOOGLE](#), [MOZILLA](#), [HIC](#)  
e.g. `#include "directory1/header.hpp"`

## <> syntax

- Any external code [WEBKIT](#)
- Only where strictly required [GOOGLE](#), [HIC](#), [MOZILLA](#), [CORECPP](#)  
C/C++ standard library headers `#include <iostream>`  
POSIX/Linux/Windows system headers (e.g. `<unistd.h>` and `<windows.h>`)

# Order of #include

LLVM, WEBKIT, MOZILLA, CORECPP.

(1) Main module/interface header, if exists (it is only one)

- space

(2) Current project includes

- space

(3) Third party includes

- space

(4) System includes

*Motivation:* System/third party includes are self-contained, local includes might not

GOOGLE: (4) → (3) → (2)

*Note:* headers within each section are lexicographic ordered

- **Report at least one function used for each include.** It helps to identify unused headers

```
<iostream> // std::cout, std::cin
```

- **Forward declarations vs. #includes**
  - *Prefer forward declaration:* reduce compile time, less dependency [CHROMIUM](#)
  - *Prefer #include:* safer [GOOGLE](#)



## Common Header/Source Filename Conventions

- `.h` `.c` `.cc`

GOOGLE, μOS(.h)

- `.hh` `.cc`

(rare)

- `.hpp` `.cpp`

μOS(.cpp)

- `.hxx` `.cxx`

(rare)

## Example

```
// [LICENSE]
#ifndef PROJECT_A_MY_HEADER
#define PROJECT_A_MY_HEADER

#include "my_class.hpp" // MyClass
 [blank line]
#include "my_dir/my_headerA.hpp" // npA::ClassA, npB::f2()
#include "my_dir/my_headerB.hpp" // np::g()
 [blank line]
#include <cmath> // std::fabs()
#include <iostream> // std::cout
#include <vector> // std::vector

// ..

#endif // PROJECT_A_MY_HEADER
```

# Preprocessing

---

- ※ **Avoid defining macros**, especially in headers GOOGLE
  - Do not use macro for enumerators, constants, and functions  
 $\mu$ OS, CORECPP<sub>1</sub>, CORECPP<sub>2</sub>
- ※ **Always put macros after** `#include` statements  $\mu$ OS
- ※ **Macros should be unique names**, e.g. use a prefix for all macros related to a project `MYPROJECT_MACRO` GOOGLE, UNREAL, CORECPP
- ※ `#undef` **macros wherever possible** GOOGLE
  - Even in the source files if *unity build* is used (merging multiple source files to improve compile time)

## ※ Always use curly brackets for multi-line macro

CLANG-TIDY

```
#define INCREMENT_TWO(x, y) (x)++; (y)++
if (do_increment)
 INCREMENT_TWO(a, b); // (b)++ will be executed unconditionally
//-----
#define INCREMENT_TWOO(x, y) \
{ \
 (x)++; \
 (y)++; \
}
```

## ※ Macro shall not have side effect

CLANG-TIDY

```
#define MIN(X, Y) (X < Y ? X : Y) // MIN(i++) -> increased twice
```

- ✘ In the definition of a function-like macro, each instance of a parameter shall be enclosed in parentheses to prevent unexpected expressions [μOS](#), [CLANG-TIDY](#)

```
#define ADD(x, y) ((x) + (y))
```

- \* **Prefer checking macro values.** It prevents mistakes deriving from missing headers

```
#define MACRO 1 // defined in another header
//-----
#if MACRO // instead of #if defined(MACRO)
```

- Put macros outside namespaces as they don't have a scope

- \* Close `#endif` with a comment with the respective condition of the first `#if`

```
#if defined(MACRO)
 ...
#endif // defined(MACRO)
```

- \* The hash mark that starts a preprocessor directive should always be at the beginning of the line



```
#if defined(MACRO)
define MACRO2
#endif
```

- \* Avoid conditional `#include` when possible

MOZILLA, CHROMIUM

- Prefer `#if defined(MACRO)` instead of `#ifdef MACRO`

Improve readability, help grep-like utils, and it is uniform with multiple conditions

```
#if defined(MACRO1) && defined(MACRO2)
```

- Place the `\` rightmost for multi-line preprocessing statements

```
#define MACRO2 \
 macro_def...
```



# Variables

---

- ※ **Always initialize variables in the declaration**

GOOGLE, CORECPP, HIC, μOS, SEI CERT, CLANG-TIDY

- ※ **Place variables in the *narrowest scope possible*.** Declare variables close to the first use

GOOGLE, CORECPP<sub>1</sub>, CORECPP<sub>2</sub>, CORECPP<sub>3</sub>

- It is allowed to declare multiple variables in the same line for improving the readability, expect for pointer or reference

GOOGLE  
(only one declaration per line) CORECPP

- Use assignment syntax `=` when performing “simple” initialization, `{}` otherwise  
[CHROMIUM](#), [CORECPP](#)
- Initialize variables with `=`, constructors with `{}` [MOZILLA](#)
- Variables with narrow scope need by `if`, `while`, `for` statements should normally be declared within those statements `if (int* ptr = f())` [GOOGLE](#)
- \* Precede boolean values with words like `is` and `did` [WEBKIT](#), [CHROMIUM](#)
- Use `\0` to indicate the null character [GOOGLE](#)

```
char n = '\0';
```

## static Global Variables

- \* **Avoid static global variables unless they are trivially destructible** [GOOGLE](#)  
e.g. `std::string str =` is not trivially destructible
  - `static` local variables with dynamic initialization are allowed
- \* **Avoid static global variables unless they are trivially constructible and destructible** [LLVM](#)
- \* **Avoid non-const static global variables** [HIC](#), [MOZILLA](#), [CORECPP](#)
- *Constant initialization* of `static` global variables should be marked with `constexpr` or `constinit` [GOOGLE](#), [CLANG-TIDY](#)
- `static` global variables should only be initialized by constant expressions (e.g. `constexpr` functions/lambdas) [GOOGLE](#), [CLANG-TIDY](#)<sub>44/76</sub>

# Conversions

\* Use `static_cast` instead of old-style cast

GOOGLE

\* Use `const_cast` to remove the `const` qualifier only for pointers and references

GOOGLE

▪ Avoid `const_cast` to remove `const`, except when implementing non-`const` getters in terms of `const` getters

CHROMIUM

▪ Use `reinterpret_cast` to do unsafe conversions between pointer types, and from/to integer types

GOOGLE

\* Use `std::bit_cast` to interpret the raw bits of a value using a different type of the same size

GOOGLE 45/76

# Enumerators

---

# Enumerators

- ※ Prefer enumerators over macros

CORECPP

- \* Prefer `enum class` over plain `enum`

UNREAL, μOS, CORECPP

- Specify the *underlying type* and *enumerator values* only when necessary

CORECPP1, CORECPP2

```
enum class MyEnum : int16_t { Abc = 1, Def = 2 }; // bad
```

- Do not cast an expression to an enumeration type

```
Color c = static_cast<Color>(3)
```

HIC

- Don't use `ALL_CAPS` for enumerators

CORECPP

# Arithmetic Types

---



## Signed vs. Unsigned Integral Types

- ✳ Don't mix signed and unsigned arithmetic [CORECPP](#), [μOS](#)
- \* Prefer *signed* integers whatever possible [GOOGLE](#), [μOS](#), [CORECPP](#),
- \* Use *unsigned* integer only for bitwise operations [GOOGLE](#), [μOS](#), [CORECPP](#)
- \* Do not shift `<<` signed operands [HIC](#), [μOS](#), [CLANG-TIDY](#)
- \* `size_t` vs. `int64_t`
  - Use `int64_t` instead of `size_t` for object counts and loop indices [GOOGLE](#)
  - Use `size_t` for object and allocation sizes, object counts, array and pointer offsets, vector indices, and so on (to avoid overflow undefined behavior) [CHROMIUM](#)
- Do not apply unary minus to operands of `unsigned` type, e.g. `-1u` [HIC](#)<sup>47/76</sup>

# Integral Types Conversion

\* Avoid silent narrowing conversions, e.g. `int i += 0.1;`

[CLANG-TIDY](#)

▪ Use brace initialization to convert/define *constant* arithmetic types (narrowing) e.g. `int64_t{MyConstant}`

[GOOGLE](#)

▪ Use `intptr_t` to convert raw pointers to integers

[GOOGLE](#)

▪ Be aware of implicit cast to `int`

# Integral Types: Size and Other Issues

## Size:

- ✳ Except `int`, use **fixed-width integer type** (e.g. `int64_t`, `int8_t`, etc.)

[CHROMIUM](#), [UNREAL](#), [GOOGLE](#), [HIC](#), [μOS](#), [CLANG-TIDY](#)

- \* **Prefer 32/64-bit signed integers over smaller data types**

[GOOGLE](#)

- 64-bit integers add no/little overhead on 64-bit platforms

## Other issues:

- Avoid redundant type, e.g. `unsigned int`, `signed int`

[WEBKIT](#)

- \* **Floating point numbers shall not be converted to integers** except through use of standard library functions `std::floor`, `std::ceil` [μOS](#), [HiC](#)

```
double d = ...;
int i = d; // BAD, prefer std::floor(d)
```

- \* **Don't convert an expression of wider floating-point type to a narrower floating-point type** [HiC](#)

```
float f1 = 1.0; // Bad
float f2 = 1.0F; // Ok
```

※ Do not directly compare floating point `==`, `<`, etc.

HIC, μOS

- Floating-point literals should always have a radix point, with digits on both sides, even if they use exponential notation `2.0f` GOOGLE, WEBKIT (opposite)

# Functions

---

- ※ **A function should perform a single logical operation** to promote simple understanding, testing, and reuse [CORECPP](#)
- ※ **Split up large functions** ( $\geq 40$ ) into logical sub-functions for improving readability and compile time [UNREAL](#), [GOOGLE](#), [CORECPP](#), [CLANG-TIDY](#)
- \* **Prefer pure functions**, namely functions that always returns the same result given the same input arguments (no external dependencies) and does not modify any state or have side effects outside of returning a value [CORECPP](#)

- \* **Limit overloaded functions.** Prefer default arguments [GOOGLE, CORECPP](#)  
(don't use default arguments) [HIC](#)
- \* **Overload a function when there are no semantic differences between variants** [GOOGLE](#)



- ※ **Don't declare functions with an excessive number of parameters.** Use a wrapper structure instead [HIC](#), [CORECPP](#), [UNREAL](#), [μOS](#)
- \* **Specify all input-only parameters before any output parameters** [GOOGLE](#)
- \* **Avoid adjacent parameters of the same type** → easy to swap by mistake [CORECPP](#)

- ※ **Pass-by-const** -*pointer or reference* for input parameters are not intended to be modified by the function [GOOGLE](#), [UNREAL](#)
- Use `std::optional` to represent optional by-value input parameters [GOOGLE](#)
- \* **Pass-by-reference** for input/output parameters [CORECPP](#)
- \* **Pass-by-reference** for output parameters, except rare cases where it is optional in which case it should be passed-by-pointer [GOOGLE](#)

- Prefer **pass-by-value** for small and trivially copyable types [CORECPP](#), [HIC](#)
- Don't **pass-by-const-value**, especially in the declaration (same signature of pass-by-value) [GOOGLE](#)  
(opposite) [AUTOSAR](#)
- \* Don't use rvalue references **&&** except for move constructors and move assignment operators [GOOGLE](#)

- \* Boolean parameters should be avoided

UNREAL

- Prefer `enum` to `bool` on function parameters

WEBKIT, CHROMIUM

- Parameter names should be the same for declaration and definition

CLANG-TIDY, HIC

- All parameters should be aligned if they do not fit in a single line (especially in the declaration)

```
void f(int a,
 const int* b);
```

# Functions Arguments

- Consider introducing variables to describe the meaning of arguments

[GOOGLE](#)

```
f(true); // BAD
bool enable_checks = true; // GOOD
f(enable_checks);
```

- Use argument comment to describe “magic number” arguments

[CLANG-TIDY](#), [GOOGLE](#)

```
void f(bool enable_checks);
f(/*enable_checks=*/true);
```

- All arguments should be aligned to the first one if they do not fit in a single line

[GOOGLE](#)

```
my_function(my var1, my_var2,
 my_var3);
```

- \* **Prefer to return values** rather than output parameters

[GOOGLE](#), [CORECPP](#)

- \* **Prefer to return by-value**

[GOOGLE](#)

- Prefer to return a `struct` /structure binding to return multiple output values

[CORECPP](#)

- Don't return `const` values

[CORECPP](#)

- Use *trailing return types* only where using the ordinary syntax is impractical or much less readable

[GOOGLE](#), [WEBKIT](#)

`int foo(int x)` instead of `auto foo(int x) -> int`

- ※ **Transfer ownership with smart pointers.** Never return pointers for new objects.

Use `std::unique_ptr` instead

[GOOGLE](#), [CHROMIUM](#), [CORECPP](#)

```
int* f() { return new int[10]; } // wrong!!
std::unique_ptr<int> f() { return new int[10]; } // correct

void FooConsumer(std::unique_ptr<Foo> ptr); // correct
```

- ※ **Never return reference/pointer for local objects.** Return a pointer only to indicate a position

[CORECPP1](#), [CORECPP2](#), [GOOGLE](#), [SEI CERT](#)

## Function Specifiers

- If a function might have to be evaluated at compile time, declare it `constexpr`  
[CORECPP1](#), [CORECPP2](#)
- Do not separate declaration and definition for `template` and `inline` functions  
[GOOGLE](#)
- Use `inline` only for small functions (e.g.  $\leq 10$  lines, no loops or switch statements)  
[GOOGLE](#), [HIC](#), [CORECPP](#)
- Do not use `inline` when declaring a function (only in the definition)
- Do not use `inline` when defining a function in a class definition  
[LLVM](#)
- Use `noexcept` when it is useful and correct



# Lambda Expressions

\* **Prefer explicit captures** if the lambda may escape the current scope [GOOGLE](#)

▪ Use default capture by reference ( `[&]` ) only when the lifetime of the lambda is obviously shorter than any potential captures [GOOGLE](#), [CORECPP](#)

▪ Do not capture variables implicitly in a lambda, e.g. `[&]{body}` [HIC](#)

▪ Omit parentheses for a C++ lambda whenever possible

```
[this] { return m_member; }
```

[WEBKIT](#)

(opposite)

[HIC](#)

```
int a[] { ++i }; // Not a lambda
[] { ++i; }; // A lambda
```

# Structs and Classes

---

- \* Use `struct` only for passive objects that carry data; everything else is `class` [GOOGLE](#), [CORECPP](#)
- \* Use `class` rather than `struct` if any member is non-`public` [CORECPP](#)
- \* Prefer `struct` instead of `pair` or `tuple` [GOOGLE](#)

# Initialization

- ※ Objects are fully initialized by constructor calls and all resources acquired must be released by the class's destructor

[GOOGLE](#), [CORECPP1](#) [CORECPP2](#), [HIC](#), [CLANG-TIDY](#)

- \* Prefer in-class initializers to member initializers

[CHROMIUM](#), [CORECPP1](#), [CORECPP2](#) [CLANG-TIDY](#)

- \* Initialize member variables in the order of member declaration

[CORECPP](#), [HIC](#)

- \* Prefer initialization to assignment in constructors

[CORECPP](#)

```
struct A {
 int _x;
 A(int x) { x = _x; } // bad
```

# Braced Initializer Lists

[MOZILLA](#)

- Initialize variables with `=`, constructors with `{}`
- Prefer braced initializer lists `{}` for constructors to clearly distinguish from function calls, avoid implicit narrowing conversion, and avoid the *most vexing parse* problem

[CORECPP<sub>1</sub>](#), [CORECPP<sub>2</sub>](#), [CORECPP<sub>3</sub>](#)

```
void f(float x) {
 int v(int(x)); // function declaration
 int v{int(x)}; // variable
}
```

- Do not use braced initializer lists `{}` for constructors (at least for containers, e.g. `std::vector`). It can be confused with `std::initializer_list`

[LLVM](#)

## Special Member Functions

- \* Use delegating constructors to represent common actions for all constructors of a class [CORECPP](#), [HIC](#)
- \* Mark *destructor* and *move constructor/assignment* `noexcept` [CORECPP<sub>1</sub>](#), [CORECPP<sub>2</sub>](#), [HIC<sub>1</sub>](#), [HIC<sub>2</sub>](#), [SEI CERT](#), [CLANG-TIDY](#)
- \* **Avoid implicit conversions.** Use the `explicit` keyword for conversion operators and constructors, especially single argument constructors [GOOGLE](#), [CORECPP<sub>1</sub>](#), [CORECPP<sub>2</sub>](#), [HIC](#), [μOS](#), [CLANG-TIDY](#)

`=default, =delete`

- \* **Indicate if a non-trivial class is copyable, move-only, or neither copyable nor movable** by using `= default` / `= delete` for constructors and assignment operators if not directly implemented

GOOGLE, MOZILLA, CHROMIUM, CORECPP

- \* **Prefer `= default` constructors** over user-defined / implicit default constructors

MOZILLA, CHROMIUM, CORECPP, HIC

- \* **Use `= delete` for mark deleted functions**

CORECPP, HIC

- \* Don't return pointers or references to non-`const` objects from `const` methods [CHROMIUM](#)
- \* Use `const` functions wherever possible [GOOGLE](#), [CHROMIUM](#), [μOS](#), [CLANG-TIDY](#)
- \* Make a function a member only if it needs direct access to the representation of a class. Use a `static` function or a free-function otherwise [CORECPP](#)
- Don't define a `class` or `enum` and declare a variable of its type in the same statement, e.g. `struct Data /*...*/ data;` [CORECPP](#)



- \* **Do not overload operators with special semantics** `&&`, `^`, `&&`, `||`, `,`, `&`, `operator""` (user-defined literals) [GOOGLE](#), [HIC](#), [μOS](#)
- \* **Prefer** to define non-modifying binary operators as **non-member functions**  
e.g. `operator==` [GOOGLE](#), [HIC](#)
- \* Place **free-functions** that interact with a class in the **same namespace**, e.g.  
`operator==` [CORECPP](#)
- \* **Declare data members** `private`, **unless they are constants**. This simplifies reasoning about invariants [GOOGLE](#), [HIC](#)

- ※ **Avoid virtual method calls in constructors** [GOOGLE](#), [CORECPP](#), [SEI CERT](#)
  
- ※ **Default arguments are allowed only on *non-virtual* functions**  
[GOOGLE](#), [CORECPP](#), [HIC](#), [CLANG-TIDY](#)
  
- ※ **A class with a *virtual function* should have a *virtual or protected destructor***  
(e.g. interfaces and abstract classes) [CORECPP](#)
  
- \* **Always use `override/final` function member keywords**  
[GOOGLE](#), [WEBKIT](#), [MOZILLA](#), [UNREAL](#), [HIC](#), [CLANG-TIDY](#), [CORECPP](#)
  
- Does not use `virtual` with `final/override` (implicit)

- \* Provide a virtual method anchor (`.cpp` implementation) for classes in headers [LLVM](#)
- \* *Multiple implementation inheritance* is discouraged [GOOGLE](#), [CHROMIUM](#), [HIC](#), [CLANG-TIDY](#)
- \* Prefer *composition* to *inheritance* [GOOGLE](#)
- \* Inheritance should be `public` [GOOGLE](#)
- \* A polymorphic class should suppress public copy/move semantics [CORECPP](#)

**※ Declare class data members in special way**

- It helps to keep track of class variables and local function variables
- The first character is helpful in filtering through the list of available variables

Examples:

- Trailing underscore (e.g. `member_var_`) GOOGLE, μOS, CHROMIUM
- Leading underscore (e.g. `_member_var`) .NET
- Public members (e.g. `m_member_var`, `mVar`) WEBKIT, MOZILLA
- Static members (e.g. `s_static_var`, `sVar`) WEBKIT, MOZILLA

PERSONAL COMMENT: Prefer `_member_var` as I read left-to-right and is less invasive

- Class members are indented

GOOGLE

\* **Class inheritance declarations order:**

`public` , `protected` , `private`

GOOGLE, μOS, CORECPP

\* **Declarations order**

GOOGLE

- (a) Types and type aliases
- (b) (Optionally, for structs only) non-static data members
- (c) Static constants
- (d) Factory functions
- (e) Constructors and assignment operators
- (f) Destructor
- (g) All other functions
- (h) All other data members

```
struct A { // passive data structure
 int x;
 float y;
};

class B {
public:
 B();
 void public_function();

protected:
 int _a; // in general, it is not public in derived classes
 void _protected_function(); // "protected_function()" is not wrong
 // it may be public in derived classes

private:
 int _x;
 float _y;

 void _private_function();
};
```

- In the constructor, each member of the initializer list should be indented on a separate line, e.g.

[GOOGLE](#), [WEBKIT](#)

```
A::A(int x1, int y1) :
 x{x1}, // double indentation
 y{y1} {
 body
}
A::A(int x1, int y1) :
 : x{x1},
 y{y1} {
 body
}
```

- If possible, **avoid** `this->` keyword
- Prefer `empty()` method over `size()` to check if a container has no items

MOZILLA

- Do not use `get` for observer methods ( `const` ) without parameters, e.g.  
`get_size()` → `size()`

WEBKIT

- Precede getters that return values via out-arguments with the word `get`

CHROMIUM

- Precede setters with the word `set` . Use bare words for getters



# Modern C++ Programming

## 14. CODE CONVENTIONS

### PART II

---

*Federico Busato*

2024-11-05

**1** auto

**2** Templates and Type Deduction

**3** Control Flow

- Redundant Control Flow
- `if/else`
- Comparison
- `switch`
- `for/while`

## 4 namespace

- using namespace Directive
- Anonymous/Unnamed Namespace
- Namespace and Class Design
- Style

## 5 Modern C++

- Keywords
- Features
- Class
- Library

## **6** Maintainability

- Code Comprehension
- Functions
- Template and Deduction
- Library

## **7** Portability

## **8** Naming

- Entities
- Variables
- Functions
- Style Conventions
- Enforcing Naming Styles

## 9 Readability and Formatting

- Horizontal Spacing
- Pointers/References
- Vertical Spacing
- Braces
- Type Decorators
- Reduce Code Verbosity
- Other Issues

## **10** Code Documentation and Comments

- Function Documentation
- Comment Syntax
- File Documentation

auto

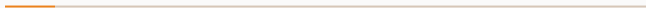



- \* **Use** `auto` to avoid type names that are noisy, obvious, or unimportant

```
auto array = new int[10];
```

```
auto var = static_cast<int>(var);
```

[LLVM](#), [GOOGLE](#)

lambdas, iterators, template expressions

unreal (only)

- \* **Do not excessively use** `auto` **for variable types**. Use `auto` only when the left type is easy to deduce looking at the right expression

[GOOGLE](#)

- Don't use `auto` when the type would be deduced to be a pointer type

```
auto* v = new int;
```

[CHROMIUM](#)

- Use `auto` for *return type deduction* only with small/simple functions and lambda expressions

[GOOGLE](#) 7/78

# Templates and Type Deduction

---

## ※ Avoid complicated template programming

GOOGLE

\* Prefer automatic template deduction `f(0)` instead of `f<int>(0)`

- Use *class template argument deduction* (CTAD) only with templates that provide at least one explicit *deduction guide*

GOOGLE

- Use *trailing return types* only where using the ordinary syntax is impractical or much less readable

GOOGLE, WEBKIT

`int foo(int x)` instead of `auto foo(int x) -> int`

# Templates and Type Deduction

- Declare *template specializations* in the same file as the primary template they specialize

[HIC](#)

```
template<typename T>
f(); // primary template

template<>
f<int>();
```

- Do not place spaces between the identifier template and its angle brackets

[WEBKIT](#)

```
template<typename U> struct Bar { };
```

# Control Flow

---

- ※ **Limit control flow complexity** (cyclomatic/cognitive complexity)

HIC, μOS, CLANG-TIDY

- \* **Avoid** `goto`

μOS, CORECPP

\* **Avoid redundant control flow** (see next slides)

- Do not use `else` after a `return / break`
- Avoid comparing boolean condition to `true/false`
- Avoid `return true/return false` pattern
- Merge multiple conditional statements

[CLANG-TIDY](#), [CORECPP](#)  
[LLVM](#), [WEBKIT](#), [CLANG-TIDY](#)

[MOZILLA](#)

```
if (condition) { // BAD
 < body1 >
 return; // <--
}
else // <-- redundant
 < body2 >
```

```
if (condition) { // GOOD
 < body1 >
 return;
}
< body2 >
```

---

```
if (condition == true) // BAD
```

```
if (condition) // GOOD
```



```
if (condition) // BAD
 return true;
else
 return false;
```

```
return condition; // GOOD
```

---

```
if (condition1) {
if (condition2) {
if (condition3) { // BAD
```

```
if (condition1 && condition2 && condition3) { // GOOD
```

```
bool condition4 = condition1 && condition2 && condition3;
if (condition4) { // GOOD
```

- \* The `if` and `else` keywords belong on separate lines

```
if (c1) <statement1>; else <statement2>; // BAD
```

GOOGLE, WEBKIT

- Don't use the ternary operator ( `?:` ) as a sub-expression

```
(i != 0) ? ((j != 0) ? 1 : 0) : 0;
```

HIC

- ※ Tests for `null/non-null`, and `zero/non-zero` should all be done with equality comparisons

[HIC](#)

(opposite) [MOZILLA](#), [WEBKIT](#), [CORECPP](#)

```
if (!ptr)
 return;
if (!count)
 return;
```

```
if (ptr == nullptr)
 return;
if (count == 0)
 return;
```

- ※ Prefer `(ptr == nullptr)` and `x > 0` over `(nullptr == ptr)` and `0 < x`

[CHROMIUM](#)

- \* Prefer `switch` to multiple `if`-statement

CORECPP

- \* Don't use default labels in fully covered `switch` over enumerations

LLVM, CORECPP

- \* In all other cases, `switch` statements should always have a `default` case

GOOGLE, UNREAL, HIC, CLANG-TIDY

## Control Flow - switch - *Style*

- `case` blocks in `switch` statements are indented twice

GOOGLE

```
switch (var) {
 case 0: {
 Foo();
 break;
 }
}
```

- A case label should line up with its `switch` statement. The case statement is indented

WEBKIT

```
switch (var) {
case 0:
 Foo();
 break;
}
```

※ Use *range-based for loops* whenever possible

[LLVM](#), [UNREAL](#), [CLANG-TIDY](#), [CORECPP1](#), [CORECPP2](#), [CORECPP3](#)

\* Prefer a `for`-statement to a `while`-statement when there is an obvious loop variable

[CORECPP](#)

\* Prefer a `while`-statement to a `for`-statement when there is no obvious loop variable

[CORECPP](#)

▪ Avoid `do-while` loop

[CORECPP](#)

- Use *early exits* ( `continue` , `break` , `return` ) to simplify the code

[LLVM](#), [CORECPP](#)

```
for (<condition1>) { // BAD
 if (<condition2>)
 ...
}
```

```
for (<condition1>) { // GOOD
 if (!<condition2>)
 continue;
 ...
}
```

- \* Turn predicate loops into predicate functions

[LLVM](#), [CORECPP](#)

```
bool var = ...;
for (<loop_condition1>) { // should be an external
 if (<condition2>) { // function
 var = ...
 break;
 }
}
```



namespace

---

# Namespace

- ※ Always place code in a namespace to avoid *global namespace pollution*

GOOGLE

- ※ Do not use *namespace aliases* `namespace nsA = other_namespace` at namespace/global scope in header files except in explicitly marked internal-only namespaces

GOOGLE, MOZILLA

- ※ Do not declare anything in the namespace `std`

GOOGLE, SEI CERT, CLANG-TIDY, CORECPP

- ※ Do not use `using namespace` declarations of any kind to import names in the `std` namespace

WEBKIT

- \* Do not use `inline` namespaces

GOOGLE<sup>21/78</sup>

- ※ **Avoid** using namespace -directives, especially at global scope

LLVM, GOOGLE, WEBKIT, UNREAL, HIC, μOS, CORECPP

```
#include <cmath> // if 'header.hpp' contains
#include "header.hpp" // 'using namespace std;'
auto f(float a) { return abs(a) * 2; } // f(3.5) returns 7 instead of 6
```

- \* **Limit** using namespace -directives at local scope and prefer explicit namespace entities declarations

GOOGLE, UNREAL, HIC, CLANG-TIDY

- using namespace is allowed in implementation files in nested namespaces

WEBKIT

# Anonymous/Unnamed Namespace

## ※ Avoid *anonymous* namespaces/ `static` in headers

[GOOGLE](#), [μOS](#), [SEI CERT](#), [CLANG-TIDY](#), [CORECPP](#)

### ▪ anonymous namespace vs. static

- anonymous namespaces instead of static everywhere

[HIC](#), [CLANG-TIDY](#), [CORECPP](#)

- anonymous namespaces only for struct / class declaration, static otherwise (easy identification)

[LLVM](#), [MOZILLA](#), [μOS](#)

### \* Anonymous namespaces and static in source files:

Items local to a source file (e.g. .cpp) file should be wrapped in an anonymous namespace/marked `static`. Anonymous namespaces/ `static` restrict symbols visibility to the translation unit, improving function call cost and reduce the size of entry point tables

[GOOGLE](#), [CHROMIUM](#), [CORECPP](#), [HIC](#), [μOS](#)<sub>23/78</sub>

- ※ **All helper functions and operators of a class need to belong to the same namespace of the class**
- \* **Prefer free functions in namespaces instead of classes**, avoid global scope functions



- \* The content of namespaces is not indented

LLVM, GOOGLE, WEBKIT

```
namespace ns {

void f() {}

}
```

- \* Close namespace declarations

LLVM, GOOGLE, WEBKIT, CLANG-TIDY

```
} // namespace <namespace_identifier>
} // namespace (for anonymous namespaces)
```

- Namespaces should have unique names based on the project name

GOOGLE

- Prefer single-line nested namespace declarations `ns1::ns2` C++17  
GOOGLE, MOZILLA
- Minimize use of nested namespaces  
CHROMIUM
- Namespaces can match hierarchy with file system hierarchy for consistency

```
include/
├── my_project/
│ ├── core.hpp
│ └── detail/
│ └── helper.hpp
```

```
namespace project_name::detail
```

# Modern C++

---



Use C++ over pure C and  
use *modern* C++ wherever possible

- ※ Use `constexpr` C++11 variables to define true constants (instead of *macro*)  
[GOOGLE](#), [WEBKIT](#), [CORECPP1](#), [CORECPP2](#)
- ※ Use `constexpr` C++20 function to ensure compile-time evaluation  
[GOOGLE](#)
- ※ Use `constexpr` C++20 to ensure constant initialization for non-constant variables  
[GOOGLE](#)
- ※ `static_assert` compile-time assertion  
[UNREAL](#), [HIC](#)

※ Prefer `enum class` C++11 instead of plain `enum` C++11

[UNREAL](#), [μOS](#), [CORECPP](#)

\* Use `auto` C++11 to avoid type names that are noisy, obvious, or unimportant

```
auto array = new int[10];
```

```
auto var = static_cast<int>(var);
```

[LLVM](#), [GOOGLE](#), [HIC](#), [CLANG-TIDY](#), [CORECPP](#)

(only for lambdas, iterators, template expressions)

[UNREAL](#)

※ `nullptr` C++11 instead of `0` or `NULL` for pointers

[GOOGLE](#), [UNREAL](#), [WEBKIT](#), [MOZILLA](#), [HIC](#), [μOS](#), [CLANG-TIDY](#), [CORECPP](#)

- \* Use the `explicit` keyword for conversion operators C++11 and constructors. Do not define implicit conversions [GOOGLE](#), [MOZILLA](#), [μOS](#)
- \* Use `using` C++11 instead `typedef` [MOZILLA](#), [CLANG-TIDY](#), [CORECPP](#)
- \* Avoid `throw` function specifier. Use `noexcept` C++11 instead [MICROSOFT BLOG](#)

※ lambda expression C++11

UNREAL

※ move semantic C++11

UNREAL

※ Use *range-based for loops* whenever possible C++11

LLVM, UNREAL, CLANG-TIDY, CORECPP<sub>1</sub>, CORECPP<sub>2</sub>, CORECPP<sub>3</sub>

\* Prefer uniform (brace) initialization C++11 when it cannot be confused with  
`std::initializer_list`

CHROMIUM

- \* `static_cast`, `reinterpret_cast`, `const_cast`, `std::bit_cast` C++20,  
instead of *old style cast* `(type)` [LLVM](#), [GOOGLE](#), [μOS](#), [HIC](#), [CLANG-TIDY](#)
- \* Use `[[deprecated]]` C++14 / `[[noreturn]]` C++11 / `[[nodiscard]]`  
C++17 to indicate deprecated functions / that do not return / result should not  
be discarded [CLANG-TIDY](#)
- \* Use `= delete` C++11 to mark deleted functions
  - Replace SFINAE with concepts C++20 [CLANG-TIDY](#)
  - Use structure binding C++17

- \* Always use `override` C++11 and `final` function member keywords  
`GOOGLE`, `WEBKIT`, `MOZILLA`, `UNREAL`, `HIC`, `CLANG-TIDY`, `CORECPP`
- \* Use `= default` C++11 constructors

- \* Use braced *direct-list-initialization* or *copy-initialization* C++11 for setting default data member value. Avoid initialization in constructors if possible [UNREAL](#)

```
struct A {
 int x = 3; // copy-initialization
 int x { 3 }; // direct-list-initialization
};
```

- Replaces explicit calls to the constructor in a return with a braced initializer list

[CLANG-TIDY](#)

```
Foo bar() { return Foo(3); }
Foo bar() { return {3}; }
```



# Modern C++ Library

- ※ Avoid C-Style memory management `malloc()/free()` and use `new/delete`  
[CORECPP](#), [CLANG-TIDY](#)
- ※ Except `int`, Use fixed-width integer type C++11 (e.g. `int64_t`, `int8_t`, etc.)  
[CHROMIUM](#), [UNREAL](#), [GOOGLE](#), [HIC](#), [μOS](#), [CLANG-TIDY](#)
- Use `std::print` C++23 [CLANG-TIDY](#)
- Uses modern type traits C++17 [CLANG-TIDY](#)

```
std::is_integral<T>::value; // --> std::is_integral_v
std::make_signed<unsigned>::type; // --> std::std::make_signed_t
```

# Maintainability

---

※ **Document code** (See code documentation section)

※ **Don't optimize without reason**

CORECPP

\* **Address compiler warnings.** Compiler warning messages mean something is wrong

UNREAL

\* **Compile-time and link-time errors should be preferred over run-time errors**

μOS, CORECPP

\* **Avoid *RTTI* (`dynamic_cast`) and *exceptions***

LLVM, GOOGLE<sub>1</sub>, GOOGLE<sub>2</sub>, MOZILLA<sub>1</sub>, MOZILLA<sub>2</sub>, HIC

※ **Do not use reserved names**

SEI CERT, CLANG-TIDY

- double underscore followed by any character `__var`
- single underscore followed by uppercase `_VAR`

▪ The `goto` statement shall not be used

μOS, CLANG-TIDY

▪ Code that is not used (commented out) should be deleted

μOS

▪ Code should not include unnecessary constructs: variables, types, unreachable code

μOS<sup>37/78</sup>

- ※ Do not depend on the order of evaluation for side effects

SEI CERT

```
f(i++, i++);
a[i++] = i;
```

- Do not perform assignments in conditional statements SEI CERT, CLANG-TIDY

```
if (a = b)
```

- \* Prefer `sizeof(variable/value)` instead of `sizeof(type)`

GOOGLE

- \* Avoid octal numbers, e.g. `int v = 0010; //8`

HIC, μOS

# Maintainability - Code Comprehension

## ※ Write self-documenting code

e.g. `(x + y - 1) / y` → `ceil_div(x, y)`

UNREAL

## ※ Use symbolic names instead of literal values in code (don't use magic numbers)

HIC, CLANG-TIDY, CORECPP

```
double area1 = 3.14 * radius * radius; // BAD
constexpr auto Pi = 3.14; // correct
double area2 = Pi * radius * radius;
```

- Use parentheses in expressions to specify the intent of the expression, especially with mixed operators

HIC, μOS, CLANG-TIDY, CORECPP

```
int r = i + j * k - 4 / 5; // BAD
if ((i != 0) && (j != 0) || (k != 0)) // BAD
```

## ※ Enforce `const`-correctness

[UNREAL](#)  
[CORECPP](#)  
[CORECPP](#)

- Pass function arguments by `const` pointer or reference
- Function members
- Use `const` iteration over containers if the loop isn't intended to modify the container

- Declare an object `const` or `constexpr` unless you want to modify its value later on

[CORECPP1](#), [CORECPP2](#), [UNREAL](#)

- but **don't** `const` all the things

<sup>1</sup>, [CORECPP](#)

- Pass by-`const` value: almost useless (copy), ABI break
- `const` return: useless (copy)
- `const` data member: disable assignment and copy constructor
- `const` local variables: verbose, rarely effective

[CLANG-TIDY](#), [UNREAL](#)

---

<sup>1</sup> Don't const all the things

# Maintainability - Functions

- ※ Use `assert` to document preconditions and assumptions

[LLVM](#), [CORECPP](#)

- Ensure that all statements are reachable for at least one combination of function inputs

[HIC](#)

- Prevent using functions that don't accept `nullptr`

[CORECPP](#)

```
void f(void*);
void f(nullptr) = delete;
// f(nullptr) // compile error
```



# Maintainability - Object Semantic

- \* Prefer RAII instead of manual resource management

[CORECPP1](#), [CORECPP2](#)

```
void f(char* name) {
 FILE* input = fopen(name, "r"); // use "ifstream input {name};" instead
 if (something) return; // BAD: if something == true,
 // ... // a file handle is leaked
 fclose(input);
}
```

- \* Never transfer ownership by a raw pointer (T\*) or reference (T&). Use object semantics, `unique_ptr`, etc. [CORECPP](#)

- \* Avoid singletons. Use a `static` member function named `singleton()` to access the instance of the singleton instead of a free function [WEBKIT](#), [CORECPP42/78](#)

## ※ Avoid complicated template programming

### \* Be aware of bug-prone deductions

```
template<typename T, int N>
void f(const T&);

template<typename T>
void f(T); // same of f(T*)

int array[3];
f(array); // call the second funtion, not f(T&)
```

- \* **Do not pass an array as a single pointer.** Prefer `std::span`, `std::mdspan`  
[CORECPP](#)
- \* **Prefer core-language features** over library facilities, e.g. `uint8_t` vs. `std::byte`
- Prefer `std::array` over plain array. It can be also used to return multiple values of the same type from a function  
[CORECPP<sub>1</sub>](#), [CORECPP<sub>2</sub>](#)
- Use `std::string_view` to refer to character sequences  
[CORECPP](#)

# Portability

---

- ※ **Ensure ISO C++ compliant code. Do not use non-standard extensions**  
see `-Wpedantic` [HIC](#), [GOOGLE1](#), [GOOGLE2](#), [μOS](#), [CORECPP](#)
- ※ Do not use deprecated C++ features, or asm declarations, e.g. `register`, `__attribute__`, `throw` (function qualifier) [HIC](#)
- ※ **Do not use `reinterpret_cast` or `union` for type punning**  
Prefer `std::bit_cast` or `std::memcpy` [CORECPP1](#), [CORECPP2](#), [HIC](#)
- ※ Except `int`, use **fixed-width integer type** (e.g. `int64_t`, `int8_t`, etc.)  
[CHROMIUM](#), [UNREAL](#), [GOOGLE](#), [HIC](#), [μOS](#), [CLANG-TIDY](#)

※ Don't use `long double`

\* **Do not use UTF characters\*** for portability, prefer ASCII [GOOGLE](#), [μOS](#)

\* If UTF is needed, **prefer UTF-8 encoding for portability** [GOOGLE](#), [CHROMIUM](#)

\* **Use the same line ending** (e.g. `'\n'`) for all files [MOZILLA](#), [CHROMIUM](#)

---

\* Trojan Source attack for introducing invisible vulnerabilities

# Naming

---

*“Beyond basic mathematical aptitude, the difference between good programmers and great programmers is verbal ability”*

***Marissa Mayer***



- \* **Naming is hard.** *Most of the time, code is shared with other developers. It is worth spending a few seconds to find the right name*
- \* **Think about the purpose to choose names**
- \* **Adopt names commonly used in real contexts** (outside the code)
- \* **Don't use the same name for different things.** Use a specific name everywhere
  - Prefer single **English** word to implementation-focused, e.g.  
`UpdateConfigFile()` → `save()`
  - Use natural word pair, e.g. `create()/destroy()`, `open()/close()`,  
`begin()/end()`, `source()/destination()`

- Don't overdecorate, e.g. `Base/Impl` , `Factory/Singleton`
- Don't list the content, e.g. `NameAndAddress` → `ContactInfo`
- Don't repeat class/enum names, e.g. `Employee::EmployeeName`
- Avoid temporal attributes, e.g. `PreLoad()` , `PostLoad()`
- Use adjectives to enrich a name, e.g. `Name` → `FullName` , `Salary` → `AnnualSalary`

\* **Abbreviations are generally bad**, longer names are better in most cases (don't be lazy)

μOS

\* **Use whole words**, except in the rare case where an abbreviation would be more canonical and easier to understand, e.g. `tmp`

WEBKIT

\* **Avoid short and very long names**. Remember that the average word length in English is 4.8

CLANG-TIDY

- Avoid names that are easily misread: similar or hard to pronounce [CORECPP](#)

✘ Avoid ambiguous characters, `o/0/0`, `I/1/1`, `s/S/5`, `Z/2`, `N/n/h`, `B/8`  
e.g. `hello` [HiC](#), [μOS](#), [CORECPP](#)

- Do not abbreviate by deleting letters within a word [GOOGLE](#)

- If you are naming something that is analogous to an existing C or C++ entity then you can follow the existing naming convention scheme [GOOGLE](#)

- \* The length of a variable should be **proportional to the size of the scope** that contains it. For example, `i` is fine within a loop

GOOGLE, CORECPP<sub>1</sub>, CORECPP<sub>2</sub>

- Names can be made singular or plural depending on whether they hold a single value or multiple values, thus arrays and collections should be plural

μOS

```
int value;
int values[N];
```

- Use common loop variable names

- `i, j, k, l` used in order
- `it` for iterators

- Make literals readable

CORECPP

```
auto c = 299'792'458; // digit separation
auto interval = 100ms; // using <chrono>
```

- \* **Should be descriptive verb** (as they represent actions)

WEBKIT

- \* **Should describe their action or effect instead of how they are implemented**, e.g. `partial_sort()` → `top_n()`

- \* **Functions that return boolean values should start with boolean verbs**, like

`is`, `has`, `should`, ~~`does`~~

`empty()` → `is_empty()`

μOS

# Naming Style Conventions

**Capital** Uppercase first word letter (sometimes called *Pascal style* or uppercase Camel style) (less readable, shorter names)

```
CapitalStyle
```

**Camel-Back** Uppercase first word letter except the first one (less readable, shorter names)

```
camelBack
```

**Snake** Lower case words separated by single underscore (good readability, longer names)

```
snake_style
```

**Macro** Upper case words separated by single underscore (sometimes called *All Capitalized* or *Screaming style*) (best readability, longer names)

```
MACRO_STYLE
```



# Naming Style Conventions - Variables/Constant

## Variable Variable names should be nouns

- Capital style e.g. `MyVar`
- Snake style e.g. `my_var`
- Global variable with `g` prefix, e.g. `gVar`
- Arguments with `a` prefix, e.g. `aVar`

LLVM, UNREAL

GOOGLE, WEBKIT, STD, μOS

MOZILLA

MOZILLA

## Constant

- Capital style + `k` prefix, e.g. `kConstantVar`
- Snake style e.g. `my_var`
- Macro style e.g. `CONSTANT_VAR`

GOOGLE, MOZILLA

μOS

OPENSTACK

## Naming Style Conventions - Function

- Camel-back style, e.g. `myFunc()` LLVM
- Capital style, e.g. `MyFunc()` GOOGLE, CHROMIUM, MOZILLA, UNREAL
- Snake style, e.g. `my_func()` WEBKIT, STD, μOS
- Snake style for accessor and mutator methods GOOGLE, CHROMIUM

# Naming Style Conventions - Enum/Namespace

## Enum

- Capital style + `k`

GOOGLE

e.g. `enum MyEnum { kEnumVar1, kEnumVar2 }`

- `e` prefix

MOZILLA

e.g. `enum MyEnum { eVar1, eVar2 }`

- Capital style

LLVM, WEBKIT, UNREAL

e.g. `enum MyEnum { EnumVar1, EnumVar2 }`

- Snake style

μOS

e.g. `enum MyEnum { enum_var1, enum_var2 }`

## Type Should be nouns

- Capital style (including classes, structs, enums, typedefs, template, etc.)

e.g. `HelloWorldClass`

LLVM, GOOGLE, WEBKIT, UNREAL

- Snake style

μOS (class), STD<sub>58/78</sub>

# Naming Style Conventions - Type/Macro/File

- Namespace**
- Snake style, e.g. `my_namespace` GOOGLE, LLVM, STD
  - Capital style, e.g. `MyNamespace` WEBKIT, UNREAL

- Macro** Macro style, e.g. `MY_MACRO`
- GOOGLE, STD, UNREAL, WEBKIT, MOZILLA, CORECPP

Macro style should be used only for macros

CORECPP<sub>1</sub>, CORECPP<sub>2</sub>, CORECPP<sub>3</sub>, CORECPP<sub>4</sub>

- File**
- Snake style ( `my_file` ) GOOGLE
  - Capital style ( `MyFile` ), could lead Windows/Linux conflicts LLVM

## Personal Comment

PERSONAL COMMENT: **Macro style** needs to be used only for macros to avoid subtle bugs. I prefer **snake style** for almost everything because it has the best readability. On the other hand, I don't want to confuse `typename`s and variables, so I use **camel style** for the former ones. Finally, I also use **camel style** for compile-time constants because they are very relevant in my work and I need to quickly identify them

# Enforcing Naming Styles

Naming style conventions can be also enforced by using tools like

`clang-tidy: readability-identifier-naming` [↗](#)

.clang-tidy configuration file

```
Checks: readability-identifier-naming
HeaderFileExtensions: ['', 'h', 'hh', 'hpp', 'hxx']
ImplementationFileExtensions: ['c', 'cc', 'cpp', 'cxx']
CheckOptions:
 readability-identifier-naming.ClassCase: lower_case
 readability-identifier-naming.MacroDefinitionCase: UPPER_CASE
```

```
class MyClass {}; // before
#define my_macro
class my_class {}; // after
#define MY_MACRO
```

# Readability and Formatting

---

- ※ **Limit line length (width)** to be at most **80 characters** long (or 100, or 120) → help code view on a terminal `LLVM` (80), `GOOGLE` (80), `μOS`(120)

PERSONAL COMMENT: I was tempted several times to use a line length > 80 to reduce the number of lines, and therefore improve the readability. Many of my colleagues use split-screens or even the notebook during travels. A line length of **80 columns** is a good compromise for everyone

- 
- Is the 80 character limit still relevant in times of widescreen monitors?
  - Linus Torvalds on 80 column limit



## ※ Use always the same indentation style

- tab → 2 spaces
- tab → 4 spaces
- (actual) tab = 4 spaces

GOOGLE, μOS  
LLVM, WEBKIT, HIC, PYTHON  
UNREAL

PERSONAL COMMENT: I worked on projects with both two and four-space tabs. I observed less bugs due to indentation and better readability with **four-space tabs**. 'Actual tabs' breaks the line length convention and can introduce tabs in the middle of the code, producing a very different formatting from the original one

- ※ Separate commands, operators, etc., by a space

LLVM, GOOGLE<sub>1</sub>, GOOGLE<sub>2</sub>, WEBKIT, CORECPP

```
if(a*b<10&&c) // BAD
if (a * c < 10 && c) // good
```

- \* Prefer consecutive alignment

```
int var1 = ...
long long int longvar2 = ...
```

- Do not place spaces around unary operators `i ++`
- Never put trailing white space or tabs at the end of a line

WEBKIT

GOOGLE  
64/78

## Pointers/References

- Declaration of pointer/reference variables or arguments may be placed with the asterisk/ampersand *adjacent* to either the *type* or to the *variable name* for all symbols in the same way

- `char* c;`
- `char *c;`
- `char * c;`

[GOOGLE](#)  
[WEBKIT](#), [CHROMIUM](#), [UNREAL](#), [CORECPP](#)

- Pointer and reference types and variables have no space after the `*` or `&`

```
char * v; // BAD
auto & v = w; // BAD
* p = 3; // BAD
v. x + 2; // BAD
x = r-> y; // BAD
```

[GOOGLE](#)

- \* Do not write excessive long file

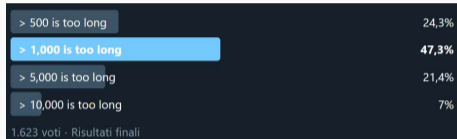

- \* Each statement should get its own line

WEBKIT, μOS, CORECPP1, CORECPP2, HIC, GOOGLE

```
x++;
y++;
if (condition)
 doIt();
```

- \* Minimize the number of empty rows. **The more code that fits on one screen, the easier it is to follow and understand the control flow of the program**

GOOGLE

- Close files with a blank line

UNREAL

- \* Multi-lines statements and complex conditions require curly braces. Use an additional boolean variable if possible

[GOOGLE<sub>1</sub>](#), [GOOGLE<sub>2</sub>](#), [WEBKIT](#)

```
if (c1 && ... &&
 c2 && ...) { // correct
 <statement>
}
```

- Curly braces are not required for single-line statements (for, while, if)

[LLVM](#), [GOOGLE](#), [WEBKIT](#)

```
if (c1) { // not mandatory
 <statement>
}
```

- Always use brace for all control statements

[MOZILLA](#), [CHROMIUM](#), [μOS](#)

### \* Use always the same style for braces

- Same line, aka Kernigham & Ritchie

GOOGLE<sub>1</sub>, GOOGLE<sub>2</sub>  
WEBKIT (function only), CORECPP (expect for function)

- Its own line, aka Allman

UNREAL, WEBKIT (class, namespace, control flow)

```
//Kernigham & Ritchie
int main() {
 code
}
```

```
// Allman
int main()
{
 code
}
```

PERSONAL COMMENT: C++ is a very verbose language. **Same line** convention helps to keep the code more compact, improving the readability

# Type Decorators

- The same concept applies to `const`
  - `const int*` *West notation*
  - `int const*` *East notation*

GOOGLE, CORECPP  
AUTOSAR (RULE A7-1-3)

PERSONAL COMMENT: I prefer **West notation** to prevent unintentional cv-qualify (const/volatile) of a reference or pointer types `char &const p`, see DCL52-CPP. Never qualify a reference type with `const` or `volatile`

- Prefer the common order of declaration `static constexpr int var`

μOS



# Reduce Code Verbosity

WEBKIT

- Use the **short name version** of built-in types, e.g.  
`unsigned` instead of `unsigned int`  
`long long` instead of `long long int`
- **Don't** `const` **all the things**. Avoid Pass by-`const` , `const` return, `const` data member, `const` local variables

## Other Issues

※ **Write all code in English**, comments included

\* Use `true`, `false` for boolean variables instead numeric values `0`, `1`

[WEBKIT](#), [CLANG-TIDY](#)

- Boolean expressions at the same nesting level that span multiple lines should have their operators on the left side of the line instead of the right side [WEBKIT](#)

```
return attribute.name() == srcAttr
 || attribute.name() == lowsrcAttr;
```

**Final note:** Most of the formatting guidelines can be forced by using `clang-tidy` [↗](#) and `clang-format` [↗](#)

**Code**

**Documentation and**

**Comments**

---

# Programmers vs. Documentation

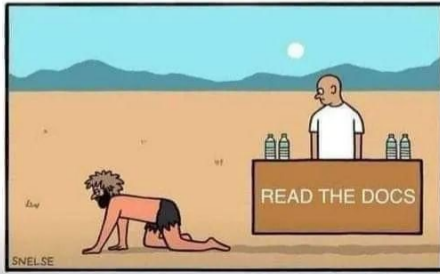
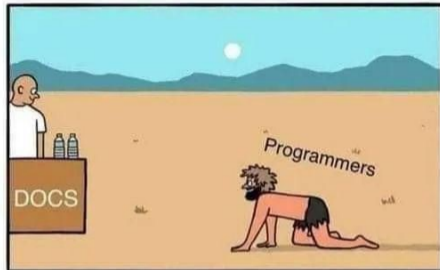

※ **Comment *what* the code does and *why***

[LLVM](#), [CORECPP](#)

- Avoid *how* it is implemented at low level
- All files should report a brief description of their purpose
- Describe classes and methods

\* **Don't say in comments what can be clearly stated in code**

[CORECPP](#)

- \* **Document each entity** (functions, classes, namespaces, definitions, etc.) **and only in the declarations**, e.g. header files

# Function Documentation

- \* **The first sentence** (beginning with `@brief`) is used as an abstract
- \* **Document the inputs:** `@param[in]`, `@param[in,out]`, , and template parameters `@tparam`

- \* **Document outputs:** return value `@return` and output parameters `@param[out]`

[GOOGLE](#), [UNREAL](#)

- \* **Document preconditions:** input ranges, impossible values (e.g. `nullptr`), status/return values meaning

[UNREAL](#)

- \* **Document program state changes** (e.g. `static`), **arguments with lifetime** beyond the duration of the method call (e.g. constructors), **performance implications**

[GOOGLE](#), [UNREAL](#)

# Comment Syntax

- \* Prefer `//` comment instead of `/* */` → prevent bugs and allow string-search tools like `grep` to identify valid code lines

[HIC](#), [μOS](#)

- Use the same style of comment `//`, `///`, `/**`, `/*!`, etc.
- Multiple lines and single line comments can have different styles

```
/**
 * comment1
 * comment2
 */
/// single line
```

- 
- [μOS++ Doxygen style guide link](#)
  - [Teaching the art of great documentation, by Google](#)

## Other Comment Issues

- Use anchors for indicating special issues: `TODO` , `FIXME` , `BUG` , etc.  
`WEBKIT` , `CHROMIUM`
- Only one space between statement and comment  
`WEBKIT`



\* Any file start with a license (even scripts)

▪ Each file should include

- `@author` name, surname, affiliation, email
- `@date` e.g. year and month
- \* `@file` the purpose of the file

in both header and source files

# Modern C++ Programming

## 15. DEBUGGING AND TESTING

---

*Federico Busato*

2024-11-05

## 1 Debugging Overview

## 2 Assertions

## 3 Execution Debugging

- Breakpoints
- Watchpoints / Catchpoints
- Control Flow
- Stack and Info
- Print
- Disassemble
- `std::breakpoint`

## **4** Memory Debugging

- valgrind

## **5** Hardening Techniques

- Stack Usage
- Standard Library Checks
- Undefined Behavior Protections
- Control Flow Protections

## **6** Sanitizers

- Address Sanitizer
- Leak Sanitizer
- Memory Sanitizers
- Undefined Behavior Sanitizer
- Sampling-Based Sanitizer

## **7** Debugging Summary

## **8** Compiler Warnings

## **9** Static Analysis

## **10** Code Testing

- Unit Testing
- Test-Driven Development (TDD)
- Code Coverage
- Fuzz Testing

## **11** Code Quality

- clang-tidy

# Feature Complete



# Debugging Overview

---



## Is this a bug?

```
for (int i = 0; i <= (2^32) - 1; i++) {
```

*“Software developers spend 35-50 percent of their time validating and debugging software. The cost of debugging, testing, and verification is estimated to account for 50-75 percent of the total budget of software development projects”*

- An **error** is a human mistake. *Errors* lead to *software defects*
- A **defects** is an unexpected behavior of the software (correctness, performance, etc.). *Defects* potentially lead to *software failures*
- A **failure** is an observable incorrect behavior

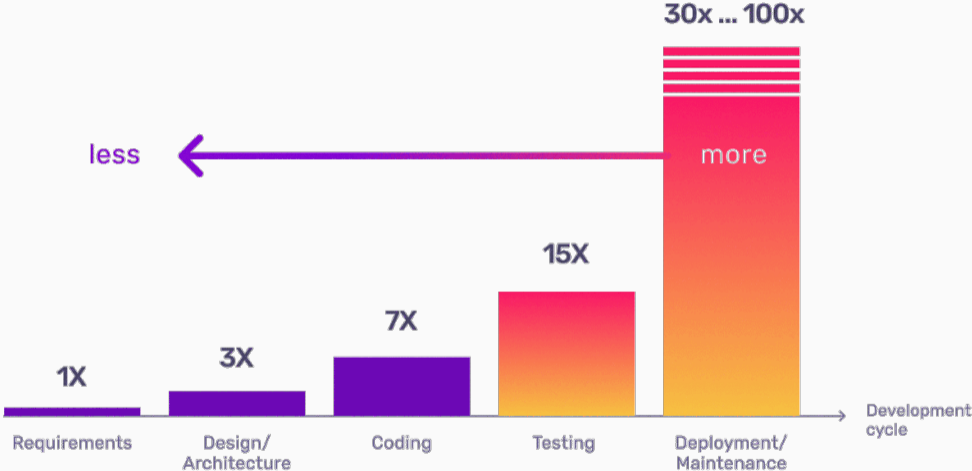

Some examples:

- **The Millennium Bug** (2000): \$100 billion
- **The Morris Worm** (1988): \$10 million (single student)
- **Ariane 5** (1996): \$370 million
- **Knight's unintended trades** (2012): \$440 million
- **Bitcoin exchange error** (2011): \$1.5 million
- **Pentium FDIV Bug** (1994): \$475 million
- **Boeing 737 MAX** (2019): \$3.9 million

see also:

11 of the most costly software errors in history

Historical Software Accidents and Errors

List of software bugs

# Types of Software Defects

Ordered by fix complexity, (time to fix):

- (1) **Typos, Syntax, Formatting** (seconds)
- (2) **Compilation Warnings/Errors** (seconds, minutes)
- (3) **Logic, Arithmetic, Runtime Errors** (minutes, hours, days)
- (4) **Resource Errors** (minutes, hours, days)
- (5) **Accuracy Errors** (hours, days)
- (6) **Performance Errors** (days)
- (7) **Design Errors** (weeks, months)

- *C++ is very error prone language*, see 60 terrible tips for a C++ developer
- *Human behavior*, e.g. copying & pasting code is very common practice and can introduce subtle bugs → check the code carefully, deep understanding of its behavior

## Program Errors

A **program error** is a set of conditions that produce an *incorrect result* or *unexpected behavior*, including performance regression, memory consumption, early termination, etc.

We can distinguish between two kind of errors:

**Recoverable** *Conditions that are not under the control of the program.* They indicates “*exceptional*” run-time conditions. e.g. file not found, bad allocation, wrong user input, etc.

**Unrecoverable** *It is a synonym of a bug.* It indicates a problem in the program logic. The program must terminate and modified. e.g. out-of-bound, division by zero, etc.

A *recoverable* should be considered *unrecoverable* if it is extremely rare and difficult to handle, e.g. bad allocation due to out-of-memory error

# Dealing with Software Defects

Software defects can be identified by:

**Dynamic Analysis** A mitigation strategy that acts on the runtime state of a program.

*Techniques:* Print, run-time debugging, sanitizers, fuzzing, unit test support, performance regression tests

*Limitations:* Infeasible to cover all program states

**Static Analysis** A proactive strategy that examines the source code for (potential) errors.

*Techniques:* Warnings, static analysis tool, compile-time checks

*Limitations:* Turing's undecidability theorem, exponential code paths



# Assertions

---

## Unrecoverable Errors and Assertions

Unrecoverable errors cannot be handled. They should be prevented by using *assertion* for ensuring *pre-conditions* and *post-conditions*

An **assertion** is a statement to detect a violated assumption. An assertion represents an *invariant* in the code

It can happen both at *run-time* ( `assert` ) and *compile-time* ( `static_assert` ).  
Run-time assertion failures should never be exposed in the normal program execution (e.g. release/public)

# Assertion

```
#include <cassert> // <-- needed for "assert"
#include <cmath> // std::is_finite
#include <type_traits> // std::is_arithmetic_v

template<typename T>
T sqrt(T value) {
 static_assert(std::is_arithmetic_v<T>, // precondition
 "T must be an arithmetic type");
 assert(std::is_finite(value) && value >= 0); // precondition
 int ret = ... // sqrt computation
 assert(std::is_finite(value) && ret >= 0 && // postcondition
 (ret == 0 || ret == 1 || ret < value));
 return ret;
}
```

**Assertions** may slow down the execution. They can be disabled by defining the `NDEBUG` macro

```
#define NDEBUG // or with the flag "-DNDEBUG"
```

Additionally, MSVC defines the `_DEBUG` macro when the `/MTd` or `/MDd` flags are provided to select the debug version of the C run-time library

[boost.org/libs/assert](http://boost.org/libs/assert) [↗](#) provides an enhanced version of `assert` to help the debugging process

The library provides the `BOOST_ASSERT(expr)` macro which is mapped to the following function (to implement and customize)

```
void boost::assertion_failed(
 const char* expr, // failed expression
 const char* function, // function name of the failed assertion
 const char* file, // file name of the failed assertion
 long line); // line number of the failed assertion
```

[boost.org/libs/stacktrace](http://boost.org/libs/stacktrace) [↗](#) allows to print the stacktrace for a given function call

`boost::stacktrace::stacktrace()` returns a string with the stacktrace

This function can be combined with `boost::assertion_failed`, exception handling, or signal handling to enhance debugging information

```
0# bar(int) at /path/to/source/file.cpp:70
1# bar(int) at /path/to/source/file.cpp:70
2# bar(int) at /path/to/source/file.cpp:70
3# bar(int) at /path/to/source/file.cpp:70
4# main at /path/to/main.cpp:93
5# __libc_start_main in /lib/x86_64-linux-gnu/libc.so.6
6# _start
```

# Execution

# Debugging

---

## How to compile and run for debugging:

```
g++ -O0 -g [-g3] <program.cpp> -o program
gdb [--args] ./program <args...>
```

- O0 Disable any code optimization for helping the debugger. It is implicit for most compilers
- g Enable debugging
  - stores the *symbol table information* in the executable (mapping between assembly and source code lines)
  - for some compilers, it may disable certain optimizations
  - slow down the compilation phase and the execution
- g3 Produces enhanced debugging information, e.g. macro definitions. Available for most compilers. Suggested instead of -g



Additional flags:

`-ggdb3` Generate specific debugging information for gdb.  
Equivalent to `-g3` with `gcc`

`-fno-omit-frame-pointer` Do not remove information that can be used to  
reconstruct the call stack

`-fasynchronous-unwind-tables` Allow precise stack unwinding

| Command                                                  | Abbr.          | Description                                      |
|----------------------------------------------------------|----------------|--------------------------------------------------|
| <code>breakpoint &lt;file&gt;:&lt;line&gt;</code>        | <code>b</code> | insert a breakpoint in a specific line           |
| <code>breakpoint &lt;function_name&gt;</code>            | <code>b</code> | insert a breakpoint in a specific function       |
| <code>breakpoint &lt;ref&gt; if &lt;condition&gt;</code> | <code>b</code> | insert a breakpoint with a conditional statement |
| <code>delete</code>                                      | <code>d</code> | delete all breakpoints or watchpoints            |
| <code>delete &lt;breakpoint_number&gt;</code>            | <code>d</code> | delete a specific breakpoint                     |
| <code>clear [function_name/line_number]</code>           |                | delete a specific breakpoint                     |
| <code>enable/disable &lt;breakpoint_number&gt;</code>    |                | enable/disable a specific breakpoint             |
| <code>info breakpoints</code>                            | <b>info b</b>  | list all active breakpoints                      |

| Command                                       | Abbr.          | Description                                                                             |
|-----------------------------------------------|----------------|-----------------------------------------------------------------------------------------|
| <code>watch &lt;expression&gt;</code>         |                | stop execution when the value of expression <u>changes</u> (variable, comparison, etc.) |
| <code>rwatch &lt;variable/location&gt;</code> |                | stop execution when variable/location <u>is read</u>                                    |
| <code>delete &lt;watchpoint_number&gt;</code> | <code>d</code> | delete a specific watchpoint                                                            |
| <code>info watchpoints</code>                 |                | list all active watchpoints                                                             |
| <code>catch throw</code>                      |                | stop execution when an <i>exception</i> is thrown                                       |

| Command                                  | Abbr.          | Description                                                    |
|------------------------------------------|----------------|----------------------------------------------------------------|
| <code>run [args]</code>                  | <code>r</code> | run the program                                                |
| <code>continue</code>                    | <code>c</code> | continue the execution                                         |
| <code>finish</code>                      | <code>f</code> | continue until the end of the current function                 |
| <code>step</code>                        | <code>s</code> | execute next line of code (follow function calls)              |
| <code>next</code>                        | <code>n</code> | execute next line of code                                      |
| <code>until &lt;program_point&gt;</code> |                | continue until reach line number, function name, address, etc. |
| <code>CTRL+C</code>                      |                | stop the execution (not quit)                                  |
| <code>quit</code>                        | <code>q</code> | exit                                                           |
| <code>help [&lt;command&gt;]</code>      | <code>h</code> | show help about command                                        |

| Command                                                            | Abbr.           | Description                                                         |
|--------------------------------------------------------------------|-----------------|---------------------------------------------------------------------|
| <code>list</code>                                                  | <code>l</code>  | print code                                                          |
| <code>list</code> <i>&lt;function or #start,#end&gt;</i>           | <code>l</code>  | print function/range code                                           |
| <code>up</code>                                                    | <code>u</code>  | move up in the call stack                                           |
| <code>down</code>                                                  | <code>d</code>  | move down in the call stack                                         |
| <code>backtrace</code> [full]                                      | <code>bt</code> | prints stack backtrace (call stack) [local vars]                    |
| <code>info args</code>                                             |                 | print current function arguments                                    |
| <code>info locals</code>                                           |                 | print local variables                                               |
| <code>info variables</code>                                        |                 | print all variables                                                 |
| <code>info</code> <i>&lt;breakpoints/watchpoints/registers&gt;</i> |                 | show information about program<br>breakpoints/watchpoints/registers |

| Command                                      | Abbr.             | Description                                      |
|----------------------------------------------|-------------------|--------------------------------------------------|
| <code>print &lt;variable&gt;</code>          | <code>p</code>    | print variable                                   |
| <code>print/h &lt;variable&gt;</code>        | <code>p/h</code>  | print variable in hex                            |
| <code>print/nb &lt;variable&gt;</code>       | <code>p/nb</code> | print variable in binary ( <code>n</code> bytes) |
| <code>print/w &lt;address&gt;</code>         | <code>p/w</code>  | print address in binary                          |
| <code>p /s &lt;char array/address&gt;</code> |                   | print char array                                 |
| <code>p *array_var@n</code>                  |                   | print <code>n</code> array elements              |
| <code>p (int[4])&lt;address&gt;</code>       |                   | print four elements of type <code>int</code>     |
| <code>p *(char**)&lt;std::string&gt;</code>  |                   | print <code>std::string</code>                   |

| Command                                             | Description                                                                                                                                                                   |
|-----------------------------------------------------|-------------------------------------------------------------------------------------------------------------------------------------------------------------------------------|
| <code>disassemble &lt;function_name&gt;</code>      | disassemble a specified function                                                                                                                                              |
| <code>disassemble &lt;0xStart,0xEnd addr&gt;</code> | disassemble function range                                                                                                                                                    |
| <code>nexti &lt;variable&gt;</code>                 | execute next line of code (follow function calls)                                                                                                                             |
| <code>stepi &lt;variable&gt;</code>                 | execute next line of code                                                                                                                                                     |
| <code>x/nfu &lt;address&gt;</code>                  | examine address<br><b>n</b> number of elements,<br><b>f</b> format ( <b>d</b> : int, <b>f</b> : float, etc.),<br><b>u</b> data size ( <b>b</b> : byte, <b>w</b> : word, etc.) |

C++26 provides the `<debugging>` library, which allows interaction with a debugger directly from the source code, without relying on platform-specific intrinsic instructions

- `breakpoint()` attempts to temporarily halt the execution of the program and transfer control to the debugger. The behavior is implementation-defined
- `breakpoint_if_debugging()` halts the execution if a debugger is detected
- `is_debugger_present()` returns `true` if the program is executed under a debugger, `false` otherwise



### The debugger automatically stops when:

- breakpoint (by using the debugger)
- assertion fail
- segmentation fault
- trigger software breakpoint (e.g. SIGTRAP on Linux)  
`github.com/scottt/debugbreak`

Full story: `www.yolinux.com/TUTORIALS/GDB-Commands.html` (it also contains a script to *de-referencing* STL Containers)

`gdb reference card V5 link`

# Memory Debugging

---

*“70% of all the vulnerabilities in Microsoft products are memory safety issues”*

**Matt Miller**, Microsoft Security Engineer

*“Chrome: 70% of all security bugs are memory safety issues”*

**Chromium Security Report**

*“you can expect at least 65% of your security vulnerabilities to be caused by memory unsafety”*

**What science can tell us about C and C++’s security**

---

Microsoft: 70% of all security bugs are memory safety issues

Chrome: 70% of all security bugs are memory safety issues

What science can tell us about C and C++’s security

*“Memory Unsafety in Apple’s OS represents 66.3%- 88.2% of all the vulnerabilities”*

*“Out of bounds (OOB) reads/writes comprise ~70% of all the vulnerabilities in Android”*

**Jeff Vander**, Google, Android Media Team

*“Memory corruption issues are the root-cause of 68% of listed CVEs”*

**Ben Hawkes**, Google, Project Zero

---

Memory Unsafety in Apple’s Operating Systems

Google Security Blog: Queue the Hardening Enhancements

Google Project Zero

Terms like *buffer overflow*, *race condition*, *page fault*, *null pointer*, *stack exhaustion*, *heap exhaustion/corruption*, *use-after-free*, or *double free* – all describe **memory safety vulnerabilities**

*Mitigation:*

- Run-time check
- Static analysis
- Avoid unsafe language constructs



valgrind [↗](#) is a tool suite to automatically detect many memory management and threading bugs

How to install the last version:

```
$ wget ftp://sourceware.org/pub/valgrind/valgrind-3.21.tar.bz2
$ tar xf valgrind-3.21.tar.bz2
$ cd valgrind-3.21
$./configure --enable-lto
$ make -j 12
$ sudo make install
$ sudo apt install libc6-dbg #if needed
```

some linux distributions provide the package through `apt install valgrid`, but it could be an old version

Basic usage:

- compile with `-g`
- `$ valgrind ./program <args...>`

Output example 1:

```
==60127== Invalid read of size 4 !!out-of-bound access
==60127== at 0x100000D9E: f(int) (main.cpp:86)
==60127== by 0x100000C22: main (main.cpp:40)
==60127== Address 0x10042c148 is 0 bytes after a block of size 40 alloc'd
==60127== at 0x1000161EF: malloc (vg_replace_malloc.c:236)
==60127== by 0x100000C88: f(int) (main.cpp:75)
==60127== by 0x100000C22: main (main.cpp:40)
```

## Output example 2:

```
!!memory leak
==19182== 40 bytes in 1 blocks are definitely lost in loss record 1 of 1
==19182== at 0x1B8FF5CD: malloc (vg_replace_malloc.c:130)
==19182== by 0x8048385: f (main.cpp:5)
==19182== by 0x80483AB: main (main.cpp:11)

==60127== HEAP SUMMARY:
==60127== in use at exit: 4,184 bytes in 2 blocks
==60127== total heap usage: 3 allocs, 1 frees, 4,224 bytes allocated
==60127==
==60127== LEAK SUMMARY:
==60127== definitely lost: 128 bytes in 1 blocks !!memory leak
==60127== indirectly lost: 0 bytes in 0 blocks
==60127== possibly lost: 0 bytes in 0 blocks
==60127== still reachable: 4,184 bytes in 2 blocks !!not deallocated
==60127== suppressed: 0 bytes in 0 blocks
```



Memory leaks are divided into four categories:

- *Definitely lost*
- *Indirectly lost*
- *Still reachable*
- *Possibly lost*

When a program terminates, it releases all heap memory allocations. Despite this, leaving memory leaks is considered a *bad practice* and *makes the program unsafe* with respect to multiple internal iterations of a functionality. If a program has memory leaks for a single iteration, is it safe for multiple iterations?

A **robust program** prevents any memory leak even when abnormal conditions occur

**Definitely lost** indicates blocks that are *not deleted at the end of the program* (return from the `main()` function). The common case is local variables pointing to newly allocated heap memory

```
void f() {
 int* y = new int[3]; // 12 bytes definitely lost
}

int main() {
 int* x = new int[10]; // 40 bytes definitely lost
 f();
}
```

**Indirectly lost** indicates blocks pointed by other heap variables that are not deleted. The common case is global variables pointing to newly allocated heap memory

```
struct A {
 int* array;
};

int main() {
 A* x = new A; // 8 bytes definitely lost
 x->array = new int[4]; // 16 bytes indirectly lost
}
```

**Still reachable** indicates blocks that are *not deleted but they are still reachable at the end of the program*

```
int* array;

int main() {
 array = new int[3];
}
// 12 bytes still reachable (global static class could delete it)
```

```
#include <cstdlib>
int main() {
 int* array = new int[3];
 std::abort(); // early abnormal termination
 // 12 bytes still reachable
 ... // maybe it is delete here
}
```

**Possibly lost** indicates blocks that are still reachable but pointer arithmetic makes the deletion more complex, or even not possible

```
#include <cstdlib>
int main() {
 int* array = new int[3];
 array++; // pointer arithmetic
 std::abort(); // early abnormal termination
 // 12 bytes still reachable
 ... // maybe it is delete here but you should be able
 // to revert pointer arithmetic
}
```

## Advanced flags:

- `--leak-check=full` print details for each “definitely lost” or “possibly lost” block, including where it was allocated
- `--show-leak-kinds=all` to combine with `--leak-check=full`. Print all leak kinds
- `--track-fds=yes` list open file descriptors on exit (not closed)
- `--track-origins=yes` tracks the origin of uninitialized values (very slow execution)

```
valgrind --leak-check=full --show-leak-kinds=all
 --track-fds=yes --track-origins=yes ./program <args...>
```

## Track stack usage:

```
valgrind --tool=drd --show-stack-usage=yes ./program <args...>
```

# Hardening Techniques

---

- `Compiler Options Hardening Guide for C and C++ [March, 2024]`
- `Hardened mode of standard library implementations`



## Compile-time Stack Usage

- `-Wstack-usage=<byte-size>` Warn if the stack usage of a function might exceed `byte-size`. The computation done to determine the stack usage is conservative (no VLA)
- `-fstack-usage` Makes the compiler output stack usage information for the program, on a per-function basis
- `-Wvla` Warn if a variable-length array is used in the code
- `-Wvla-larger-than=<byte-size>` Warn for declarations of variable-length arrays whose size is either unbounded, or bounded by an argument that allows the array size to exceed `byte-size` bytes

## Compile-time Stack Protection

- `-Wtrampolines` Check whether the compiler generates trampolines for pointers to nested functions which may interfere with stack virtual memory protection
- `-Wl,-z,noexecstack` Enable data execution prevention by marking stack memory as non-executable

## Run-time Stack Usage

- `-fstack-clash-protection` Enables run-time checks for variable-size stack allocation validity
- `-fstack-protector-strong` Enables run-time checks for stack-based buffer overflows using strong heuristic
- `-fstack-protector-all` Enables run-time checks for stack-based buffer overflows for all functions

`_FORTIFY_SOURCE` **define**: the compiler provides buffer overflow checks for the following functions:

`memcpy`, `mempcpy`, `memmove`, `memset`, `strcpy`, `stpcpy`, `strncpy`, `strcat`,  
`strncat`, `sprintf`, `vsprintf`, `snprintf`, `vsnprintf`, `gets`.

Recent compilers (e.g. GCC 12+, Clang 9+) allow detects buffer overflows with enhanced coverage, e.g. dynamic pointers, with `_FORTIFY_SOURCE=3` \*

---

\*GCC's new fortification level: The gains and costs

```
#include <cstring> // std::memset
#include <string> // std::stoi
int main(int argc, char** argv) {
 int size = std::stoi(argv[1]);
 char buffer[24];
 std::memset(buffer, 0xFF, size);
}
```

```
$ gcc -O1 -D_FORTIFY_SOURCE program.cpp -o program
$./program 12 # OK
$./program 32 # Wrong
$ *** buffer overflow detected ***: ./program terminated
```

## Standard Library Preconditions

The standard library provides run-time precondition checks for library calls, such as bounds-checks for strings and containers, and null-pointer checks, etc.

`-D_GLIBCXX_ASSERTIONS` for `libstdc++` (GCC)

`-D_LIBCPP_ASSERT` , `_LIBCPP_HARDENING_MODE_EXTENSIVE` for `libc++` (LLVM):

- `-fno-strict-overflow` Prevent code optimization (code elimination) due to signed integer undefined behavior
- `-fwrapv` Signed integer has the same semantic of unsigned integer, with a well-defined wrap-around behavior
- `-fno-strict-aliasing` Strict aliasing means that two objects with the same memory address are not same if they have a different type, undefined behavior otherwise. The flag disables this constraint

- `-fno-delete-null-pointer-checks` NULL pointer dereferencing is undefined behavior and the compiler can assume that it never happens. The flag disable this optimization
- `-ftrivial-auto-var-init[=<hex pattern>]` Ensures that default initialization initializes variables with a fixed 1-byte pattern. Explicit uninitialized variables requires the `[[uninitialized]]` attribute



# Control Flow Protections

- `-fcf-protection=full` Enable control flow protection to counter Return Oriented Programming (ROP) and Jump Oriented Programming (JOP) attacks on many x86 architectures
- `-mbranch-protection=standard` Enable branch protection to counter Return Oriented Programming (ROP) and Jump Oriented Programming (JOP) attacks on AArch64

## Other Run-time Checks

- `-fPIE -pie` Position-Independent Executable enables the support for address space layout randomization, which makes exploits more difficult.
- `-Wl,-z,relro,-z,now` Prevents modification of the Global Offset Table (locations of functions from dynamically linked libraries) after the program startup
- `-Wl,-z,nodlopen` Restrict `dlopen(3)` calls to shared objects

# Sanitizers

---

**Sanitizers** are compiler-based instrumentation components to perform *dynamic* analysis

Sanitizer are used during development and testing to discover and diagnose memory misuse bugs and potentially dangerous undefined behavior

Sanitizer are implemented in `Clang` (from 3.1), `gcc` (from 4.8) and `Xcode`

Project using Sanitizers:

- Chromium
- Firefox
- Linux kernel
- Android

# Address Sanitizer

Address Sanitizer [↗](#) is a memory error detector

- heap/*stack/global* out-of-bounds
- memory leaks
- use-after-free, use-after-return, use-after-scope
- double-free, invalid free
- initialization order bugs
- \* Similar to valgrind but faster (50X slowdown)

```
clang++ -O1 -g -fsanitize=address -fno-omit-frame-pointer <program>
```

-O1 disable inlining

-g generate symbol table

- 
- [github.com/google/sanitizers/wiki/AddressSanitizer](https://github.com/google/sanitizers/wiki/AddressSanitizer)
  - [gcc.gnu.org/onlinedocs/gcc/Instrumentation-Options.html](https://gcc.gnu.org/onlinedocs/gcc/Instrumentation-Options.html)

LeakSanitizer [↗](#) is a run-time *memory leak* detector

- integrated into AddressSanitizer, can be used as standalone tool
- \* almost no performance overhead until the very end of the process

```
g++ -O1 -g -fsanitize=address -fno-omit-frame-pointer <program>
clang++ -O1 -g -fsanitize=leak -fno-omit-frame-pointer <program>
```

- 
- [github.com/google/sanitizers/wiki/AddressSanitizerLeakSanitizer](https://github.com/google/sanitizers/wiki/AddressSanitizerLeakSanitizer)
  - [gcc.gnu.org/onlinedocs/gcc/Instrumentation-Options.html](https://gcc.gnu.org/onlinedocs/gcc/Instrumentation-Options.html)

# Memory Sanitizers

Memory Sanitizer [↗](#) is a detector of *uninitialized* reads

- stack/heap-allocated memory read before it is written
- \* Similar to valgrind but faster (3X slowdown)

```
clang++ -O1 -g -fsanitize=memory -fno-omit-frame-pointer <program>
```

```
-fsanitize-memory-track-origins=2
```

track origins of uninitialized values

Note: not compatible with Address Sanitizer

- 
- [github.com/google/sanitizers/wiki/MemorySanitizer](https://github.com/google/sanitizers/wiki/MemorySanitizer)
  - [gcc.gnu.org/onlinedocs/gcc/Instrumentation-Options.html](https://gcc.gnu.org/onlinedocs/gcc/Instrumentation-Options.html)

# Undefined Behavior Sanitizer

UndefinedBehaviorSanitizer [↗](#) is an *undefined behavior* detector

- signed integer overflow, floating-point types overflow, enumerated not in range
  - out-of-bounds array indexing, misaligned address
  - divide by zero
  - etc.
- \* Not included in valgrind

```
clang++ -O1 -g -fsanitize=undefined -fno-omit-frame-pointer <program>
```



# Undefined Behavior Sanitizer

`-fsanitize=<options>` :

`undefined` All of the checks other than `float-divide-by-zero`, `unsigned-integer-overflow`, `implicit-conversion`, `local-bounds` and the `nullability-*` group of checks

`float-divide-by-zero` Undefined behavior in C++, but defined by Clang and IEEE-754

`integer` Checks for undefined or suspicious integer behavior (e.g. unsigned integer overflow)

`implicit-conversion` Checks for suspicious behavior of implicit conversions

`local-bounds` Out of bounds array indexing, in cases where the array bound can be statically determined

`nullability` Checks passing `null` as a function parameter, assigning `null` to an lvalue, and returning `null` from a function

# Sampling-Based Sanitizer

[GWPSan](#) [↗](#) is a framework to implement low-overhead sampling-based dynamic binary instrumentation, designed for detecting various bugs where more expensive dynamic analysis would otherwise not be feasible

- `tsan` (thread-sanitizer) data races
- `uar` use-after-return bugs
- `lmsan` Uninitialized variables

```
clang++ -fexperimental-sanitize-metadata=atomics,uar <program>
```

# Sanitizers vs. Valgrind

| Bug                       | Valgrind detection | ASan detection |
|---------------------------|--------------------|----------------|
| Uninitialized memory read | Yes                | No *           |
| Write overflow on heap    | Yes                | Yes            |
| Write overflow on stack   | No                 | Yes            |
| Read overflow on heap     | Yes                | Yes            |
| Read underflow on heap    | Yes                | Yes            |
| Read overflow on stack    | No                 | Yes            |
| Use-after-free            | Yes                | Yes            |
| Use-after-return          | No                 | Yes            |
| Double-free               | Yes                | Yes            |
| Memory leak               | Yes                | Yes            |
| Undefined behavior        | No                 | No **          |

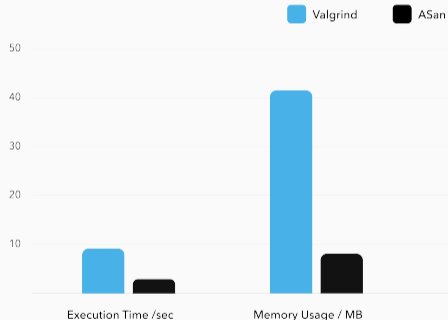

# Debugging Summary

---

# How to Debug Common Errors

## Segmentation fault

- gdb, valgrind, sanitizers
- Segmentation fault when just entered in a function → stack overflow

## Double free or corruption

- gdb, valgrind, sanitizers

## Infinite execution

- gdb + (CTRL + C)

## Incorrect results

- valgrind + assertion + gdb + sanitizers

# Compiler Warnings

---

# Compiler Warnings - GCC and Clang

**Enable** specific warnings:

```
g++ -W<warning> <args...>
```

**Disable** specific warnings:

```
g++ -Wno-<warning> <args...>
```

Common warning flags to minimize accidental mismatches:

`-Wall` Enables many standard warnings (~50 warnings)

`-Wextra` Enables some extra warning flags that are not enabled by `-Wall` (~15 warnings)

`-Wpedantic` Issue all the warnings demanded by strict ISO C/C++

Enable ALL warnings, only clang: `-Weverything`

# Compiler Warnings - MSVC

**Enable** specific warnings:

```
cl.exe /W<level><warning_id> <args...>
```

**Disable** specific warnings:

```
cl.exe /We<warning_id> <args...>
```

Common warning flags to minimize accidental mismatches:

`/W1` Severe warnings

`/W2` Significant warnings

`/W3` Production quality warnings

`/W4` Informational warnings

`/Wall` All warnings



# Static Analysis

---

**Static analysis** is the process of source code examination to find potential issues

**Benefits** of static code analysis:

- Problem identification before the execution
- Analyze the program outside the execution environment
- The analysis is independent from the run-time tests
- Enforce code quality and compliance by ensuring that the code follows specific rules and standards
- Identify security vulnerabilities

## Static Analyzers - Clang and GCC



The Clang Static Analyzer [↗](#) (LLVM suite) finds bugs by reasoning about the semantics of code (may produce false positives)

```
void test() {
 int i, a[10];
 int x = a[i]; // warning: array subscript is undefined
}
```

```
scan-build make
```



The GCC Static Analyzer [↗](#) can diagnose various kinds of problems in C/C++ code at compile-time (e.g. double-free, use-after-free, stdio related, etc) by adding the `-fanalyzer` flag

## Static Analyzers - cppcheck



The MSVC Static Analyzer [↗](#) Enables code analysis and control options (e.g. double-free, use-after-free, stdio related, etc) by adding the `/analyze` flag



cppcheck [↗](#) provides code analysis to detect bugs, undefined behavior and dangerous coding construct. The goal is to detect only real errors in the code (i.e. have very few false positives)

```
cppcheck --enable=warning,performance,style,portability,information,error
 <src_file/directory>
```

```
cmake -DCMAKE_EXPORT_COMPILE_COMMANDS=ON .
cppcheck --enable=<enable_flags> --project=compile_commands.json
```

## Popular Static Analyzers - PVS-Studio, SonarLint



PVS-Studio [↗](#) is a high-quality *proprietary* (free for open source projects) static code analyzer supporting C, C++

*Customers:* IBM, Intel, Adobe, Microsoft, Nvidia, Bosh, IdGames, EpicGames, etc.



SonarSource [↗](#) is a static analyzer which inspects source code for bugs, code smells, and security vulnerabilities for multiple languages (C++, Java, etc.)

SonarLint plugin is available for Visual Code, Visual Studio Code, Eclipse, and IntelliJ IDEA

## Other Static Analyzers - FBInfer, DeepCode

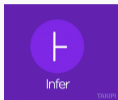

[FBInfer](#) [↗](#) is a static analysis tool (also available online) to check for null pointer dereferencing, memory leak, coding conventions, unavailable APIs, etc.

*Customers:* Amazon AWS, Facebook/Oculus, Instagram, WhatsApp, Mozilla, Spotify, Uber, Sky, etc.



[deepCode](#) [↗](#) is an AI-powered code review system, with machine learning systems trained on billions of lines of code from open-source projects

Available for Visual Studio Code, Sublime, IntelliJ IDEA, and Atom

# Code Testing

---

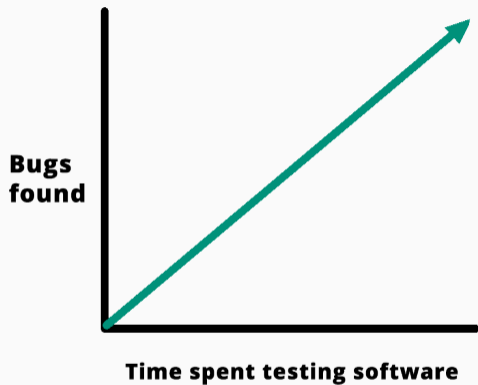

see Case Study 4: The \$440 Million Software Error at Knight Capital



**Unit Test** A *unit* is the smallest piece of code that can be logically isolated in a system. *Unit test* refers to the verification of a *unit*. It supposes the full knowledge of the code under testing (*white-box* testing)  
Goals: meet specifications/requirements, fast development/debugging

**Functional Test** Output validation instead of the internal structure (*black-box* testing)  
Goals: performance, regression (same functionalities of previous version), stability, security (e.g. sanitizers), composability (e.g. integration test)

**Unit testing** involves breaking your program into pieces, and subjecting each piece to a series of tests

*Unit testing* should observe the following key features:

- **Isolation:** Each unit test should be *independent* and avoid external interference from other parts of the code
- **Automation:** Non-user interaction, easy to run, and manage
- **Small Scope:** Unit tests focus on small portions of code or specific functionalities, making it easier to identify bugs

**Popular C++ Unit testing frameworks:**

catch, doctest, Google Test, CppUnit, Boost.Test

Meeting C++ Community Survey  
Which unit test libraries do you use? (n=865)

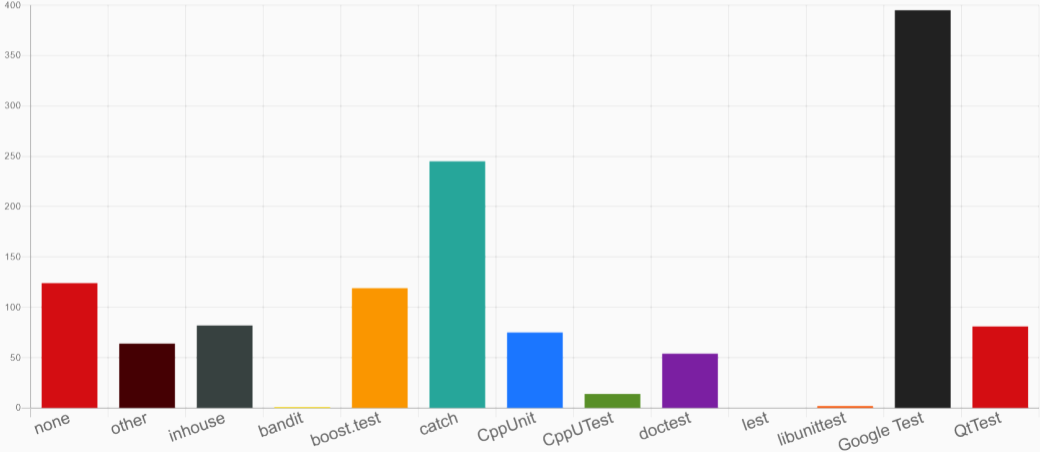

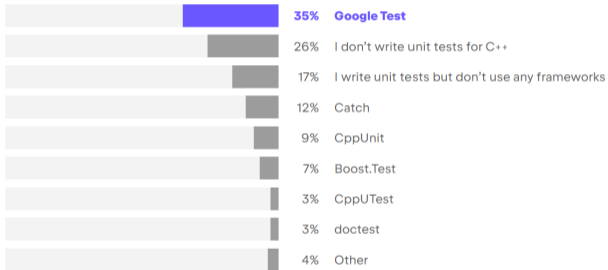

The statistic that a quarter of developers aren't writing unit tests freaks me out. I don't feel strongly about how you express those or what framework you use, but we all do need to be writing tests.

**Titus Winters**

Principal Engineer at Google

# Test-Driven Development (TDD)

*Unit testing* is often associated with the **Test-Driven Development (TDD)** methodology. The practice involves the definition of *automated functional tests* before implementing the functionality

The process consists of the following steps:

1. Write a test for a new functionality
2. Write the minimal code to pass the test
3. Improve/Refactor the code iterating with the test verification
4. Go to 1.

## Test-Driven Development (TDD) - Main advantages

- **Software design.** Strong focus on interface definition, expected behavior, specifications, and requirements before working at lower level
- **Maintainability/Debugging Cost** Small, incremental changes allow you to catch bugs as they are introduced. Later refactoring or the introduction of new features still rely on well-defined tests
- **Understandable behavior.** New user can learn how the system works and its properties from the tests
- **Increase confidence.** Developers are more confident that their code will work as intended because it has been extensively tested
- **Faster development.** Incremental changes, high confidence, and automation make it easy to move through different functionalities or enhance existing ones

Catch2 [↗](#) is a multi-paradigm test framework for C++

### Catch2 features

- Header only and no external dependencies
- Assertion macro
- Floating point tolerance comparisons

### Basic usage:

- Create the test program
- Run the test

```
$./test_program [<TestName>]
```

- 
- [github.com/catchorg/Catch2](https://github.com/catchorg/Catch2)
  - The Little Things: Testing with Catch2

```
#define CATCH_CONFIG_MAIN // This tells Catch to provide a main()
#include "catch.hpp" // only do this in one cpp file

unsigned Factorial(unsigned number) {
 return number <= 1 ? number : Factorial(number - 1) * number;
}

"Test description and tag name"
TEST_CASE("Factorials are computed", "[Factorial]") {
 REQUIRE(Factorial(1) == 1);
 REQUIRE(Factorial(2) == 2);
 REQUIRE(Factorial(3) == 6);
 REQUIRE(Factorial(10) == 3628800);
}

float floatComputation() { ... }

TEST_CASE("floatCmp computed", "[floatComputation]") {
 REQUIRE(floatComputation() == Approx(2.1));
}
```



**Code coverage** is a measure used to describe the degree to which the source code of a program is executed when a particular execution/test suite runs

gcov and llvm-profdata/llvm-cov are tools used in conjunction with compiler instrumentation (gcc, clang) to interpret and visualize the raw code coverage generated during the execution

gcovr and lcov are utilities for managing gcov/llvm-cov at higher level and generating code coverage results

## Step for code coverage:

- Compile with `--coverage` flag (objects + linking)
- Run the program / test
- Visualize the results with `gcovr`, `llvm-cov`, `lcov`

program.cpp:

```
#include <iostream>
#include <string>

int main(int argc, char* argv[]) {
 int value = std::stoi(argv[1]);
 if (value % 3 == 0)
 std::cout << "first\n";
 if (value % 2 == 0)
 std::cout << "second\n";
}
```

```
$ gcc -g --coverage program.cpp -o program
$./program 9
first
$ gcovr -r --html --html-details <path> # generate html
or
$ lcov --coverage --directory . --output-file coverage.info
$ genhtml coverage.info --output-directory <path> # generate html
```

```

1: 4:int main(int argc, char* argv[]) {
1: 5: int value = std::stoi(argv[1]);
1: 6: if (value % 3 == 0)
1: 7: std::cout << "first\n";
1: 8: if (value % 2 == 0)
#####: 9: std::cout << "second\n";
4: 10:}

```

Current view: [top level](#) - /home/ubuntu/workspace/prove

Test: coverage.info

Date: 2018-02-09

|            | Hit | Total | Coverage |
|------------|-----|-------|----------|
| Lines:     | 6   | 7     | 85.7 %   |
| Functions: | 3   | 3     | 100.0 %  |

| Filename    | Line Coverage                                                                                  | Functions     |
|-------------|------------------------------------------------------------------------------------------------|---------------|
| program.cpp |  85.7 % 6 / 7 | 100.0 % 3 / 3 |

Current view: [top level](#) - [home/ubuntu/workspace/prove](#) - program.cpp (source / functions)

Test: coverage.info

Date: 2018-02-09

|            | Hit | Total | Coverage |
|------------|-----|-------|----------|
| Lines:     | 6   | 7     | 85.7 %   |
| Functions: | 3   | 3     | 100.0 %  |

| Line data | Source code                                              |
|-----------|----------------------------------------------------------|
| 1         | : #include <iostream>                                    |
| 2         | : #include <string>                                      |
| 3         | :                                                        |
| 4         | 1: int main(int argc, char* argv[]) {                    |
| 5         | 1:     int value = std::stoi(argv[1]); // convert to int |
| 6         | 1:     if (value % 3 == 0)                               |
| 7         | 1:         std::cout << "first";                         |
| 8         | 1:     if (value % 2 == 0)                               |
| 9         | 0:         std::cout << "second";                        |
| 10        | 4: }                                                     |

# Coverage-Guided Fuzz Testing

A **fuzzer** is a specialized tool that tracks which areas of the code are reached, and generates *mutations* on the corpus of input data in order to *maximize* the code coverage

LibFuzzer [↗](#) is the library provided by LLVM and feeds fuzzed inputs to the library via a specific fuzzing entrypoint

The *fuzz target function* accepts an array of bytes and does something interesting with these bytes using the API under test:

```
extern "C" int LLVMFuzzerTestOneInput(const uint8_t* Data,
 size_t Size) {
 DoSomethingInterestingWithMyAPI(Data, Size);
 return 0;
}
```

# Code Quality

---

**lint:** The term was derived from the name of the undesirable bits of fiber

clang-tidy [↗](#) provides an extensible framework for diagnosing and fixing typical *programming errors*, like *style violations*, *interface misuse*, or *bugs* that can be deduced via static analysis

```
$ cmake -DCMAKE_EXPORT_COMPILE_COMMANDS=ON .
$ clang-tidy -p .
```

clang-tidy searches the configuration file .clang-tidy file located in the closest parent directory of the input file

clang-tidy is included in the LLVM suite

**Coding Guidelines:**

- CERT Secure Coding Guidelines
- C++ Core Guidelines
- High Integrity C++ Coding Standard

**Supported Code Conventions:**

- Fuchsia
- Google
- LLVM

**Bug Related:**

- Android related
- Boost library related
- Misc
- Modernize
- Performance
- Readability
- clang-analyzer checks
- bugprone code constructors

```
.clang-tidy
```

```
Checks: 'android-*,boost-*,bugprone-*,cert-*,cppcoreguidelines-*,
clang-analyzer-*,fuchsia-*,google-*,hicpp-*,llvm-*,misc-*,modernize-*,
performance-*,readability-*
```

# Modern C++ Programming

## 16. C++ ECOSYSTEM

### CMAKE AND OTHER TOOLS

---

*Federico Busato*

2024-11-05



## **1** CMake

- ctest

## **2** Code Documentation

- doxygen

## **3** Code Statistics

- Count Lines of Code
- Cyclomatic Complexity Analyzer

## 4 Other Tools

- Code Formatting - `clang-format`
- Compiler Explorer
- Code Transformation - `CppInsights`
- AI-Powered Code Completion
- Local Code Search - `ugrep`, `ripgrep`, `hypergrep`
- Code Search Engine - `searchcode`, `grep.app`
- Code Benchmarking - `Quick-Bench`
- Font for Coding

# CMake

---



CMake [↗](#) is an *open-source*, cross-platform family of tools designed to build, test and package software

CMake is used to control the software compilation process using simple platform and compiler independent configuration files, and *generate* native Makefile/Ninja and workspaces that can be used in the compiler environment of your choice

CMake features:

- Turing complete language (if/else, loops, functions, etc.)
- Multi-platform (Windows, Linux, etc.)
- Open-Source
- Generate: makefile, ninja, etc.
- Supported by many IDEs: Visual Studio, Clion, Eclipse, etc.

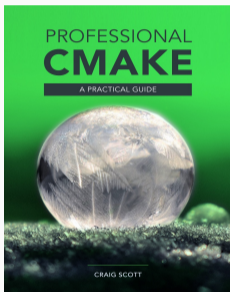

**Professional CMake: A Practical Guide**  
(14th)  
*C. Scott, 2023*

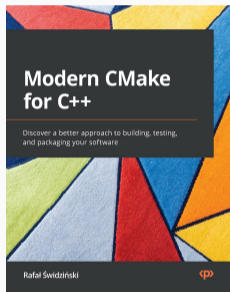

**Modern CMake for C++ (2nd)**  
*R. Świdziński, 2024*

- 19 reasons why CMake is actually awesome
- An Introduction to Modern CMake
- Effective Modern CMake
- Awesome CMake
- Useful Variables

# Install CMake

## Using PPA repository

```
$ wget -O - https://apt.kitware.com/keys/kitware-archive-latest.asc 2>/dev/null |
 gpg --dearmor - | sudo tee /etc/apt/trusted.gpg.d/kitware.gpg >/dev/null
$ sudo apt-add-repository 'deb https://apt.kitware.com/ubuntu/ focal main' # bionic, xenial
$ sudo apt update
$ sudo apt install cmake cmake-curses-gui
```

## Using the installer or the pre-compiled binaries: [cmake.org/download/](https://cmake.org/download/)

```
download the last cmake package, e.g. cmake-x.y.z-linux-x86_64.sh
$ sudo sh cmake-x.y.z-linux-x86_64.sh
```

## A Minimal Example

CMakeLists.txt:

```
project(my_project) # project name

add_executable(program program.cpp) # compile command
```

```
we are in the project root dir
$ mkdir build # 'build' dir is needed for isolating temporary files
$ cd build
$ cmake .. # search for CMakeLists.txt directory
$ make # makefile automatically generated
```

Scanning dependencies of target program

[100%] Building CXX object CMakeFiles/out\_program.dir/program.cpp.o

Linking CXX executable program

[100%] Built target program



# Parameters and Message

CMakeLists.txt:

```
project(my_project)
add_executable(program program.cpp)

if (VAR)
 message("VAR is set, NUM is ${NUM}")
else()
 message(FATAL_ERROR "VAR is not set")
endif()
```

```
$ cmake ..
VAR is not set
$ cmake -DVAR=ON -DNUM=4 ..
VAR is set, NUM is 4
...
[100%] Built target program
```

# Language Properties

```
project(my_project
 DESCRIPTION "Hello World"
 HOMEPAGE_URL "github.com/"
 LANGUAGES CXX)

cmake_minimum_required(VERSION 3.15)

set(CMAKE_CXX_STANDARD 14) # force C++14
set(CMAKE_CXX_STANDARD_REQUIRED ON)
set(CMAKE_CXX_EXTENSIONS OFF) # no compiler extensions

add_executable(program ${PROJECT_SOURCE_DIR}/program.cpp) # $
PROJECT_SOURCE_DIR is the root directory of the project
```

# Target Commands

```
add_executable(program) # also add_library(program)

target_include_directories(program
 PUBLIC include/
 PRIVATE src/)
target_include_directories(program SYSTEM ...) for system headers

target_sources(program # best way for specifying
 PRIVATE src/program1.cpp # program sources and headers
 PRIVATE src/program2.cpp
 PUBLIC include/header.hpp)

target_compile_definitions(program PRIVATE MY_MACRO=ABCEF)

target_compile_options(program PRIVATE -g)

target_link_libraries(program PRIVATE boost_lib)

target_link_options(program PRIVATE -s)
```

# Build Types

```
project(my_project) # project name
cmake_minimum_required(VERSION 3.15) # minimum version

add_executable(program program.cpp)

if (CMAKE_BUILD_TYPE STREQUAL "Debug") # "Debug" mode
 # cmake already adds "-g -O0"

 message("DEBUG mode")
 if (CMAKE_COMPILER_IS_GNUCXX) # if compiler is gcc
 target_compile_options(program "-g3")
 endif()
elseif (CMAKE_BUILD_TYPE STREQUAL "Release") # "Release" mode
 message("RELEASE mode") # cmake already adds "-O3 -DNDEBUG"
endif()
```

```
$ cmake -DCMAKE_BUILD_TYPE=Debug ..
```

# Custom Targets and File Managing

```
project(my_project)
add_executable(program)

add_custom_target(echo_target # makefile target name
 COMMAND echo "Hello" # real command
 COMMENT "Echo target")

find all .cpp file in src/ directory
file(GLOB_RECURSE SRCS ${PROJECT_SOURCE_DIR}/src/*.cpp)
compile all *.cpp file
target_sources(program PRIVATE ${SRCS}) # prefer the explicit file list instead
```

```
$ cmake ..
$ make echo_target
```

## Local and Cached Variables

*Cached variables* can be reused across multiple runs, while *local variables* are only visible in a single run. Cached `FORCE` variables can be modified only after the initialization

```
project(my_project)

set(VAR1 "var1") # local variable
set(VAR2 "var2" CACHE STRING "Description1") # cached variable
set(VAR3 "var3" CACHE STRING "Description2" FORCE) # cached variable
option(OPT "This is an option" ON) # boolean cached variable
 # same of var2

message(STATUS "${VAR1}, ${VAR2}, ${VAR3}, ${OPT}")
```

```
$ cmake .. # var1, var2, var3, ON
$ cmake -DVAR1=a -DVAR2=b -DVAR3=c -DOPT=d .. # var1, b, var3, d
```

# Manage Cached Variables

```
$ cmake . # or 'cmake-gui'
```

```
Page 1 of 1
CMAKE_BUILD_TYPE Release
CMAKE_INSTALL_PREFIX /usr/local
OPT ON
VAR2 var2
VAR3 var3

CMAKE_BUILD_TYPE: Choose the type of build, options are: None(CMAK
Press [enter] to edit option Press [d] to delete an entry
Press [c] to configure
Press [h] for help Press [q] to quit without generating
Press [t] to toggle advanced mode (Currently Off)
```

# Find Packages

```
project(my_project) # project name
cmake_minimum_required(VERSION 3.15) # minimum version

add_executable(program program.cpp)
find_package(Boost 1.36.0 REQUIRED) # compile only if Boost library
 # is found

if (Boost_FOUND)
 target_include_directories("${PROJECT_SOURCE_DIR}/include" PUBLIC ${Boost_INCLUDE_DIRS})
else()
 message(FATAL_ERROR "Boost Lib not found")
endif()
```



## Compile Commands

Generate JSON compilation database (`compile_commands.json`)

It contains the exact compiler calls for each file that are used by other tools

```
project(my_project)
cmake_minimum_required(VERSION 3.15)

set(CMAKE_EXPORT_COMPILE_COMMANDS ON) # <--

add_executable(program program.cpp)
```

Change the C/C++ compiler:

```
CC=clang CXX=clang++ cmake ..
```

CTest is a testing tool (integrated in CMake) that can be used to automate updating, configuring, building, testing, performing memory checking, performing coverage

```
project(my_project)
cmake_minimum_required(VERSION 3.5)
add_executable(program program.cpp)

enable_testing()

add_test(NAME Test1 # check if "program" returns 0
 WORKING_DIRECTORY ${PROJECT_SOURCE_DIR}/build
 COMMAND ./program <args>) # command can be anything

add_test(NAME Test2 # check if "program" print "Correct"
 WORKING_DIRECTORY ${PROJECT_SOURCE_DIR}/build
 COMMAND ./program <args>)

set_tests_properties(Test2
 PROPERTIES PASS_REGULAR_EXPRESSION "Correct")
```

Basic usage (call ctest):

```
$ make test # run all tests
```

ctest usage:

```
$ ctest -R Python # run all tests that contains 'Python' string
$ ctest -E Iron # run all tests that not contain 'Iron' string
$ ctest -I 3,5 # run tests from 3 to 5
```

Each ctest command can be combined with other tools (e.g. valgrind)

## ctest with Different Compile Options

It is possible to combine a custom target with ctest to compile the same code with different compile options

```
add_custom_target(program-compile
 COMMAND mkdir -p test-release test-ubsan test-asan # create dirs
 COMMAND cmake .. -B test-release # -B change working dir
 COMMAND cmake .. -B test-ubsan -DUBSAN=ON
 COMMAND cmake .. -B test-asan -DASAN=ON
 COMMAND make -C test-release -j20 program # -C run make in a
 COMMAND make -C test-ubsan -j20 program # different dir
 COMMAND make -C test-asan -j20 program)

enable_testing()

add_test(NAME Program-Compile
 COMMAND make program-compile)
```



[xmake](#) [↗](#) is a cross-platform build utility based on Lua.

Compared with `makefile/CMakeLists.txt`, the configuration syntax is more concise and intuitive. It is very friendly to novices and can quickly get started in a short time. Let users focus more on actual project development

Comparison: `xmake` vs `cmake`

**Code**

**Documentation**

---

Doxygen [↗](#) is the de facto standard tool for generating documentation from annotated C++ sources

## Doxygen usage

- comment the code with `///` or `/** comment */`
- generate doxygen base configuration file

```
$ doxygen -g
```

- modify the configuration file `Doxyfile`
- generate the documentation

```
$ doxygen <config_file>
```

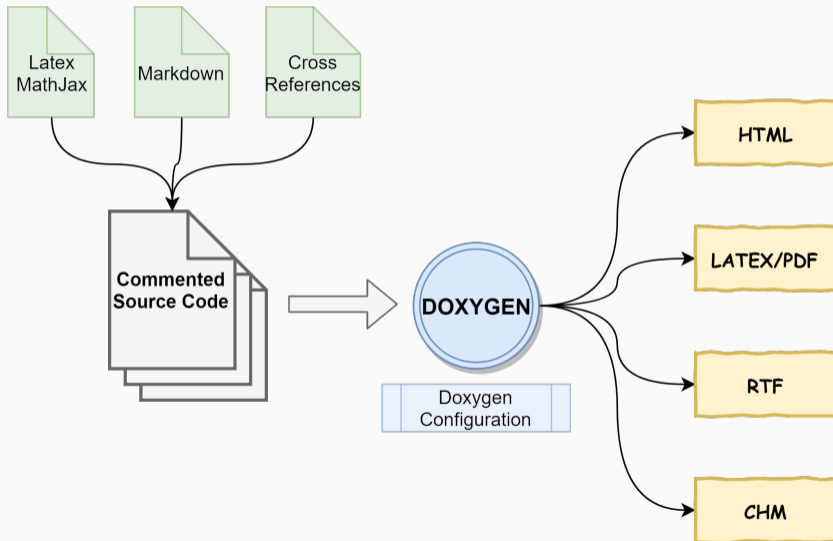



Doxygen requires the following tags for generating the documentation:

- `@file` Document a file
- `@brief` Brief description for an entity
- `@param` Run-time parameter description
- `@tparam` Template parameter description
- `@return` Return value description

- *Automatic cross references* between functions, variables, etc.
- *Specific highlight*. Code `<code>`, input/output parameters `@param[in] <param>`
- *Latex/MathJax* `$<code>$`
- *Markdown* ([Markdown Cheatsheet link](#)), Italic text `*<code>*`, bold text `**<code>**`, table, list, etc.
- Call/Hierarchy graph can be useful in large projects (requires graphviz)  
`HAVE_DOT = YES`  
`GRAPHICAL_HIERARCHY = YES`  
`CALL_GRAPH = YES`  
`CALLER_GRAPH = YES`

```
/**
 * @file
 * @copyright MyProject
 * license BSD3, Apache, MIT, etc.
 * @author MySelf
 * @version v3.14159265359
 * @date March, 2018
 */

/// @brief Namespace brief description
namespace my_namespace {

/// @brief "Class brief description"
/// @tparam R "Class template for"
template<typename R>
class A {
```

```
/**
 * @brief "What the function does?"
 * @details "Some additional details",
 * Latex/MathJax: \sqrt{a}
 * @tparam T Type of input and output
 * @param[in] input Input array
 * @param[out] output Output array
 * @return `true` if correct,
 * `false` otherwise
 * @remark it is useful if ...
 * @warning the behavior is undefined if
 * @p input is `nullptr`
 * @see related_function
 */
template<typename T>
bool my_function(const T* input, T* output);

/// @brief
void related_function();
```

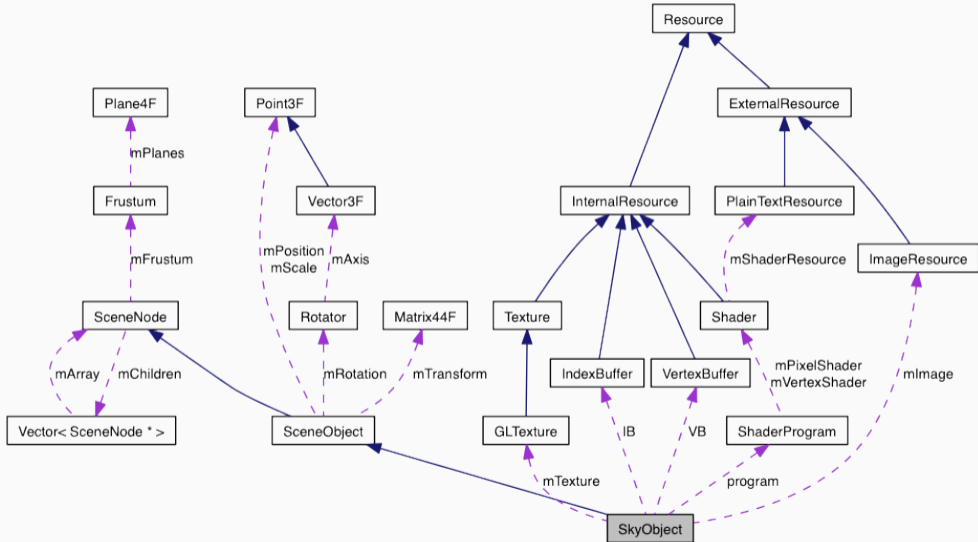

# Doxygen Alternatives

`M.CSS Doxygen C++ theme`

`Doxypress Doxygen fork`

`clang-doc LLVM tool`

`Sphinx Clear, Functional C++ Documentation with Sphinx + Breathe  
+ Doxygen + CMake`

`standardese The nextgen Doxygen for C++ (experimental)`

`HDoc The modern documentation tool for C++ (alpha)`

`Adobe Hyde Utility to facilitate documenting C++`

# Code Statistics

---

## Count Lines of Code - cloc

`cloc` [↗](#) counts blank lines, comment lines, and physical lines of source code in many programming languages

```
$cloc my_project/
```

```
4076 text files.
```

```
3883 unique files.
```

```
1521 files ignored.
```

```
http://cloc.sourceforge.net v 1.50 T=12.0 s (209.2 files/s, 70472.1 lines/s)
```

```

```

| Language     | files | blank | comment | code   |
|--------------|-------|-------|---------|--------|
| C            | 135   | 18718 | 22862   | 140483 |
| C/C++ Header | 147   | 7650  | 12093   | 44042  |
| Bourne Shell | 116   | 3402  | 5789    | 36882  |

```

```

**Features:** filter by-file/language, SQL database, archive support, line count diff, etc.

Lizard [↗](#) is an extensible Cyclomatic Complexity Analyzer for many programming languages including C/C++

**Cyclomatic Complexity:** is a software metric used to indicate the complexity of a program. It is a quantitative measure of the number of linearly independent paths through a program source code

```
$lizard my_project/
=====
NLOC CCN token param function@line@file

10 2 29 2 start_new_player@26@./html_game.c
6 1 3 0 set_shutdown_flag@449@./httpd.c
24 3 61 1 server_main@454@./httpd.c

```

- CCN: cyclomatic complexity (should not exceed a threshold)
- NLOC: lines of code without comments
- token: Number of conditional statements



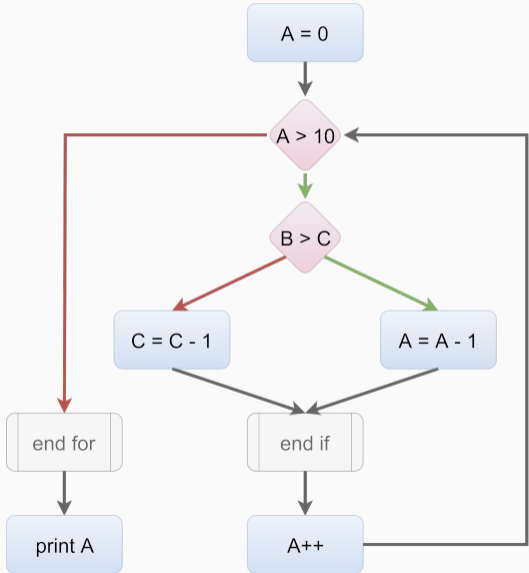

CCN = 3

---

| CC    | Risk Evaluation                            |
|-------|--------------------------------------------|
| 1-10  | a simple program, <i>without much risk</i> |
| 11-20 | more complex, <i>moderate risk</i>         |
| 21-50 | complex, <i>high risk</i>                  |
| > 50  | untestable program, <i>very high risk</i>  |

---

---

| CC   | Guidelines                                        |
|------|---------------------------------------------------|
| 1-5  | The routine is probably fine                      |
| 6-10 | Start to think about ways to simplify the routine |
| > 10 | Break part of the routine                         |

---

Risk: Lizard: 15, OCLint: 10

- 
- [www.microsoftpressstore.com/store/code-complete-9780735619678](http://www.microsoftpressstore.com/store/code-complete-9780735619678)
  - [blog.feabhas.com/2018/07/code-quality-cyclomatic-complexity](http://blog.feabhas.com/2018/07/code-quality-cyclomatic-complexity)

# Other Tools

---

## Code Formatting - clang-format

clang-format [↗](#) is a tool to automatically format C/C++ code (and other languages)

```
$ clang-format <file/directory>
```

clang-format searches the configuration file .clang-format file located in the closest parent directory of the input file

clang-format example:

```
IndentWidth: 4
UseTab: Never
BreakBeforeBraces: Linux
ColumnLimit: 80
SortIncludes: true
```

# Compiler Explorer (assembly and execution)

Compiler Explorer [↗](#) is an interactive tool that lets you type source code and see assembly output, control flow graph, optimization hint, etc.



The screenshot displays the Compiler Explorer interface. On the left, a window titled 'C++ source #1' shows the following C++ code:

```
1 #include <algorithm>
2
3 int method(int a, int b) {
4 return a + b;
5 }
6
```

On the right, the assembly output for 'x86-64 clang 5.0.0' is shown. The assembly code is as follows:

```
11010 .LX0: .text // \s+ Intel Demangle
1 method(int, int): # @method(int, int)
2 push rbp
3 mov rbp, rsp
4 mov dword ptr [rbp - 4], edi
5 mov dword ptr [rbp - 8], esi
6 mov esi, dword ptr [rbp - 4]
7 add esi, dword ptr [rbp - 8]
8 mov eax, esi
9 pop rbp
10 ret
```

**Key features:** support multiple architectures and compilers

CppInsights [↗](#) See what your compiler does behind the scenes



About

Source:

```
1 #include <cstdio>
2 #include <vector>
3
4 int main()
5 {
6 const char arr[10]{2,4,6,8};
7
8 for(const char& c : arr)
9 {
10 printf("c=%c\n", c);
11 }
12 }
```

Insight:

```
1 #include <cstdio>
2 #include <vector>
3
4 int main()
5 {
6 const char arr[10]{2,4,6,8};
7
8 {
9 auto&& __range1 = arr;
10 const char * __begin1 = __range1;
11 const char * __end1 = __range1 + 10L;
12
13 for(; __begin1 != __end1; ++__begin1)
14 {
15 const char & c = *__begin1;
16 printf("c=%c\n", static_cast<int>(c));
17 }
18 }
19 }
```

**AI-Powered Code Completion** tools help writing code faster by drawing context from comments and code to suggest individual lines and whole functions

*Common features:*

- Semantic completion
- Recognize common language patterns
- Use the documentation to infer this function name, return type, and arguments
- Suggest bug fixes
- Generate comments, documentation, and even Pull Request text

They are commonly provided as plug-in for the most popular editors and IDE

- [CoPilot](#) ↗
- [TabNine](#) ↗
- [Codeium](#) ↗
- [Replit Ghostwriter](#) ↗
- [CodeWhisperer](#) ↗



# Local Code Search - ugrep, ripgrep, hypergrep

ugrep [↗](#), Ripgrep [↗](#), Hypergrep [↗](#) are code-searching-oriented tools for regex pattern

## Features:

- Default recursively searches
- Skip .gitignore patterns, binary and hidden files/directories
- Windows, Linux, Mac OS support
- Up to 100x faster than GNU grep

```
[andrew@Cheetah rust] rg -i rustacean
src/doc/book/nightly-rust.md
92:[Mibbit][mibbit]. Click that link, and you'll be chatting with other Rustaceans

src/doc/book/glossary.md
3:Not every Rustacean has a background in systems programming, nor in computer

src/doc/book/getting-started.md
176:Rustaceans (a silly nickname we call ourselves) who can help us out. Other great
376:Cargo is Rust's build system and package manager, and Rustaceans use Cargo to

src/doc/book/guessing-game.md
444:it really easy to re-use libraries, and so Rustaceans tend to write smaller

CONTRIBUTING.md
322:* [rustaceans.org][ro] is helpful, but mostly dedicated to IRC
333:[ro]: http://www.rustaceans.org/
[andrew@Cheetah rust] □
```

# Code Search Engine - searchcode

Searchcode [↗](#) is a free source code search engine

## Features:

- Search over 20 billion lines of code from 7,000,000 projects
- Search sources: github, bitbucket, gitlab, google code, sourceforge, etc.

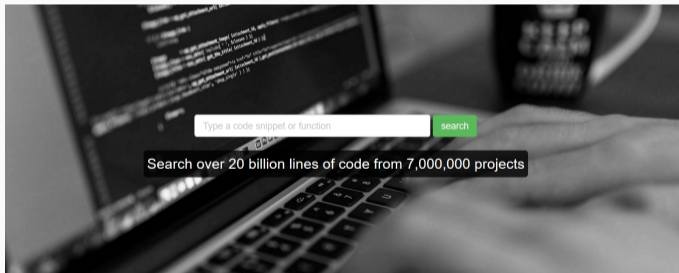

[grep.app](#)  searches across a half million GitHub repos

## // `grep.app`

Search across a half million git repos

Case sensitive     Regular expression     Whole words

# Code Benchmarking - Quick-Bench

[Quick-benchmark](#) [↗](#) is a micro benchmarking tool intended to quickly and simply compare the performances of two or more code snippets. The benchmark runs on a pool of AWS machines

compiler = clang-3.8 ▾    std = c++17 ▾    optim = O3 ▾    STL = libstdc++(GNU) ▾

[🕒 Run Benchmark](#)     Record disassembly     Clear cached results

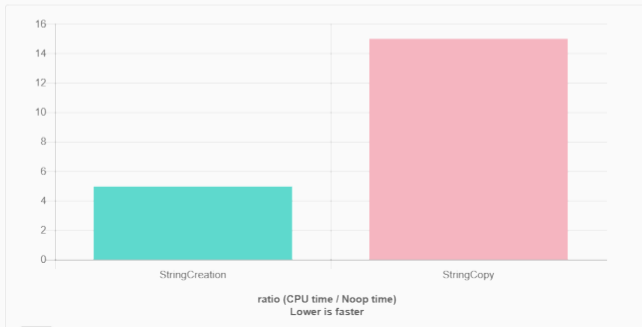

# Font for Coding

Many editors allow adding optimized fonts for programming which improve legibility and provide extra symbols (ligatures)

|             |                                   |                                                |
|-------------|-----------------------------------|------------------------------------------------|
| Scope       | <code>→ ⇒ :: __</code>            | <code>-&gt; =&gt; :: __</code>                 |
| Equality    | <code>= ≡ ≠ ≠≠ == === ≠ ≠≠</code> | <code>== === != !=/= == === != !===</code>     |
| Comparisons | <code>≤ ≥ ≤ ≥ ↔</code>            | <code>&lt;= &gt;= &lt;= &gt;= &lt;=&gt;</code> |

Some examples:

- JetBrains Mono
- Fira Code
- Microsoft Cascadia
- Consolas Ligaturized

# Modern C++ Programming

## 17. UTILITIES

---

*Federico Busato*

2024-11-05

## 1 I/O Stream

- Manipulator
- `ofstream/ifstream`

## 2 Strings and `std::print`

- `std::string`
- Conversion from/to Numeric Values
- `std::string_view`
- `std::format`
- `std::print`

## 3 View

- `std::span`

## 4 Math Libraries



## 5 Random Number

- Basic Concepts
- C++ `<random>`
- Seed
- PRNG Period and Quality
- Distribution
- Recent Algorithms and Performance
- Quasi-random

## **6** Time Measuring

- Wall-Clock Time
- User Time
- System Time

## 7 Std Classes

- `std::pair`
- `std::tuple`
- `std::variant`
- `std::optional`
- `std::any`
- `std::stacktrace`

## 8 Filesystem Library

- Query Methods
- Modify Methods

# I/O Stream

---

`<iostream>` input/output library refers to a family of classes and supporting functions in the C++ Standard Library that implement stream-based input/output capabilities

There are four predefined iostreams:

- `cin` standard input (`stdin`)
- `cout` standard output (`stdout`) [buffered]
- `cerr` standard error (`stderr`) [unbuffered]
- `clog` standard error (`stderr`) [unbuffered]

buffered: the content of the buffer is not write to disk until some events occur

Basic I/O Stream manipulator:

- `flush` flushes the output stream `cout << flush;`
- `endl` shortcut for `cout << "\n" << flush;`  
`cout << endl`
- `flush` and `endl` force the program to synchronize with the terminal → very slow operation!

- **Set integral representation:** default: dec

```
cout << dec << 0xF; prints 16
```

```
cout << hex << 16; prints 0xF
```

```
cout << oct << 8; prints 10
```

- Print the underlying **bit representation** of a value:

```
#include <bitset>
std::cout << std::bitset<32>(3.45f); // (32: num. of bits)
// print 01000000010111001100110011001101
```

- **Print true/false text:**

```
cout << boolalpha << 1; prints true
```

```
cout << boolalpha << 0; prints false
```

```
<iomanip>
```

- **Set decimal precision:** default: 6

```
cout << setprecision(2) << 3.538; → 3.54
```

- **Set float representation:** default: `std::defaultfloat`

```
cout << setprecision(2) << fixed << 32.5; → 32.50
```

```
cout << setprecision(2) << scientific << 32.5; → 3.25e+01
```

- **Set alignment:** default: right

```
cout << right << setw(7) << "abc" << "##"; → ____abc##
```

```
cout << left << setw(7) << "abc" << "##"; → abc____##
```

(better than using `tab \t`)



# I/O Stream - `std::cin`

`std::cin` is an example of *input* stream. Data coming from a source is read by the program. In this example `cin` is the standard input

```
#include <iostream>

int main() {
 int a;
 std::cout << "Please enter an integer value:" << endl;
 std::cin >> a;

 int b;
 float c;
 std::cout << "Please enter an integer value "
 << "followed by a float value:" << endl;
 std::cin >> b >> c; // read an integer and store into "b",
 // then read a float value, and store
 // into "c"
}
```

`ifstream`, `ofstream` are output and input stream too

`<fstream>`

- **Open a file for reading**

Open a file in input mode: `ifstream my_file("example.txt")`

- **Open a file for writing**

Open a file in output mode: `ofstream my_file("example.txt")`

Open a file in append mode: `ofstream my_file("example.txt", ios::out | ios::app)`

- **Read a line** `getline(my_file, string)`

- **Close a file** `my_file.close()`

- **Check the stream integrity** `my_file.good()`

- **Peek the next character**

```
char current_char = my_file.peek()
```

- **Get the next character (and advance)**

```
char current_char = my_file.get()
```

- **Get the position of the current character in the input stream**

```
int byte_offset = my_file.tellg()
```

- **Set the char position in the input sequence**

```
my_file.seekg(byte_offset) (absolute position)
```

```
my_file.seekg(byte_offset, position) (relative position)
```

where position can be: `ios::beg` (the begin), `ios::end` (the end),  
`ios::cur` (current position)

- **Ignore characters until the delimiter is found**

```
my_file.ignore(max_stream_size, <delim>)
```

e.g. skip until end of line `\n`

- **Get a pointer to the stream buffer object currently associated with the stream**

```
my_file.rdbuf()
```

can be used to redirect file stream

# I/O Stream - Example 1

Open a file and print line by line:

```
#include <iostream>
#include <fstream>

int main() {
 std::ifstream fin("example.txt");
 std::string str;
 while (std::getline(fin, str))
 std::cout << str << "\n";
 fin.close();
}
```

An alternative version with redirection:

```
#include <iostream>
#include <fstream>

int main() {
 std::ifstream fin("example.txt");
 std::cout << fin.rdbuf();
 fin.close();
}
```

## I/O Stream - Example 2

example.txt:

```
23_70__44\n
\t57\t89
```

The input stream is independent from the type of space (multiple space, tab, new-line `\n`, `\r\n`, etc.)

Another example:

```
#include <iostream>
#include <fstream>

int main() {
 std::ifstream fin("example.txt");
 char c = fin.peek(); // c = '2'
 while (fin.good()) {
 int var;
 fin >> var;
 std::cout << var;
 } // print 2370445789
 fin.seekg(4);
 c = fin.peek(); // c = '0'
 fin.close();
}
```

## I/O Stream -Check the End of a File

- Check the current character

```
while (fin.peek() != std::char_traits<char>::eof()) // C: EOF
 fin >> var;
```

- Check if the read operation fails

```
while (fin >> var)
 ...
```

- Check if the stream past the end of the file

```
while (true) {
 fin >> var
 if (fin.eof())
 break;
}
```

## I/O Stream (checkRegularType)

Check if a file is a **regular file** and can be read/written

```
#include <sys/types.h>
#include <sys/stat.h>
bool checkRegularFile(const char* file_path) {
 struct stat info;
 if (::stat(file_path, &info) != 0)
 return false; // unable to access
 if (info.st_mode & S_IFDIR)
 return false; // is a directory
 std::ifstream fin(file_path); // additional checking
 if (!fin.is_open() || !fin.good())
 return false;
 try { // try to read
 char c; fin >> c;
 } catch (std::ios_base::failure&) {
 return false;
 }
 return true;
}
```



## I/O Stream - File size

Get the **file size** in bytes in a **portable** way:

```
long long int fileSize(const char* file_path) {
 std::ifstream fin(file_path); // open the file
 fin.seekg(0, ios::beg); // move to the first byte
 std::istream::pos_type start_pos = fin.tellg();
 // get the start offset
 fin.seekg(0, ios::end); // move to the last byte
 std::istream::pos_type end_pos = fin.tellg();
 // get the end offset
 return end_pos - start_pos; // position difference
}
```

see [C++17](#) file system utilities

# Strings and `std::print`

---

`std::string` is a wrapper of character sequences

More flexible and safer than raw char array but can be slower

```
#include <string>

int main() {
 std::string a; // empty string
 std::string b("first");

 using namespace std::string_literals; // C++14
 std::string c = "second"s; // C++14
}
```

`std::string` supports `constexpr` in C++20

- `empty()` returns `true` if the string is empty, `false` otherwise
- `size()` returns the number of characters in the string
- `find(string)` returns the position of the first substring equal to the given character sequence or `npos` if no substring is found
- `rfind(string)` returns the position of the last substring equal to the given character sequence or `npos` if no substring is found
- `find_first_of(char_seq)` returns the position of the first character equal to one of the characters in the given character sequence or `npos` if no characters is found
- `find_last_of(char_seq)` returns the position of the last character equal to one of the characters in the given character sequence or `npos` if no characters is found

`npos` special value returned by string methods

- `new_string substr(start_pos)`  
returns a substring [start\_pos, end]
- `new_string substr(start_pos, count)`  
returns a substring [start\_pos, start\_pos + count)
- `clear()` removes all characters from the string
- `erase(pos)` removes the character at position
- `erase(start_pos, count)`  
removes the characters at positions [start\_pos, start\_pos + count)
- `replace(start_pos, count, new_string)`  
replaces the part of the string indicated by [start\_pos, start\_pos + count) with new\_string
- `c_str()`  
returns a pointer to the raw char sequence

- **access specified character** `string1[i]`
- **string copy** `string1 = string2`
- **string compare** `string1 == string2`  
works also with `!=, <, ≤, >, ≥`
- **concatenate two strings** `string_concat = string1 + string2`
- **append characters to the end** `string1 += string2`

# Conversion from/to Numeric Values

Converts a string to a numeric value **C++11**:

- `stoi(string)` string to signed integer
- `stol(string)` string to long signed integer
- `stoul(string)` string to long unsigned integer
- `stoull(string)` string to long long unsigned integer
- `stof(string)` string to floating point value (float)
- `stod(string)` string to floating point value (double)
- `stold(string)` string to floating point value (long double)
- **C++17** `std::from_chars(start, end, result, base)` fast string conversion (no allocation, no exception)

Converts a numeric value to a string:

- **C++11** `to_string(numeric_value)` numeric value to string

## Examples

```
std::string str("si vis pacem para bellum");
cout << str.size(); // print 24
cout << str.find("vis"); // print 3
cout << str.find_last_of("bla"); // print 21, 'l' found

cout << str.substr(7, 5); // print "pacem", pos=7 and count=5
cout << str[1]; // print 'i'
cout << (str == "vis"); // print false
cout << (str < "z"); // print true
const char* raw_str = str.c_str();

cout << string("a") + "b"; // print "ab"
cout << string("ab").erase(0); // print 'b'

char* str2 = "34";
int a = std::stoi(str2); // a = 34;
std::string str3 = std::to_string(a); // str3 = "34"
```



## Tips

- Conversion from integer to char letter (e.g.  $3 \rightarrow 'C'$ ):

```
static_cast<char>('A'+ value)
```

value  $\in [0, 26]$  (English alphabet)

- Conversion from char to integer (e.g.  $'C' \rightarrow 3$ ): `value - 'A'`

value  $\in [0, 26]$

- Conversion from digit to char number (e.g.  $3 \rightarrow '3'$ ):

```
static_cast<char>('0'+ value)
```

value  $\in [0, 9]$

- char to string `std::string(1, char_value)`

C++17 `std::string_view` describes a minimum common interface to interact with string data:

- `const std::string&`
- `const char*`

The purpose of `std::string_view` is to avoid copying data which is already owned by the original object

```
#include <string>
#include <string_view>

std::string str = "abc"; // new memory allocation + copy
std::string_view = "abc"; // only the reference
```

std::string\_view provides similar functionalities of std::string

```
#include <iostream>
#include <string>
#include <string_view>

void string_op1(const std::string& str) {}
void string_op2(std::string_view str) {}

string_op1("abcdef"); // allocation + copy
string_op2("abcdef"); // reference

const char* str1 = "abcdef";
std::string str2("abcdef"); // allocation + copy
std::cout << str2.substr(0, 3); // print "abc"

std::string_view str3(str1); // reference
std::cout << str3.substr(0, 3); // print "abc"
```

std::string\_view supports constexpr constructor and methods

```
constexpr std::string_view str1("abc");
constexpr std::string_view str2 = "abc";

constexpr char c = str1[0]; // 'a'
constexpr bool b = (str1 == str2); // 'true'

constexpr int size = str1.size(); // '3'
constexpr std::string_view str3 = str1.substr(0, 2); // "ab"

constexpr int pos = str1.find("bc"); // '1'
```

`printf` *functions*: no automatic type deduction, error prone, not extensible

`stream` *objects*: very verbose, hard to optimize

C++20 `std::format` provides python style formatting:

- Type-safe
- Support positional arguments
- Extensible (support user-defined types)
- Return a `std::string`

## Integer formatting

```
std::format("{} ", 3); // "3 "
std::format("{:b} ", 3); // "101 "
```

## Floating point formatting

```
std::format("{:.1f} ", 3.273); // "3.1 "
```

## Alignment

```
std::format("{:>6} ", 3.27); // " 3.27 "
std::format("{:<6} ", 3.27); // "3.27 "
```

## Argument reordering

```
std::format("{1} - {0} ", 1, 3); // "3 - 1 "
```

C++23 introduces `std::print()` `std::println()`

```
std::print("Hello, {}!\n", name);
```

```
std::println("Hello, {}!", name); // prints a newline
```

# View





C++20 introduces `std::span` which is a non-owning view of an underlying sequence or array

A `std::span` can either have a static extent, in which case the number of elements in the sequence is known at compile-time, or a dynamic extent

```
template<
 class T,
 std::size_t Extent = std::dynamic_extent
> class span;
```

```
#include
#include <array>
#include <vector>

int array1[] = {1, 2, 3};
std::span s1{array1}; // static extent

std::array<int, 3> array2 = {1, 2, 3};
std::span s2{array2}; // static extent

auto array3 = new int[3];
std::span s3{array3, 3}; // dynamic extent

std::vector<int> v{1, 2, 3};
std::span s4{v.data(), v.size()}; // dynamic extent

std::span s5{v}; // dynamic extent
```

```
void f(std::span<int> span) {
 for (auto x : span) // range-based loop (safe)
 cout << x;
 std::fill(span.begin(), span.end(), 3); // std algorithms
}

int array1[] = {1, 2, 3};
f(array1);

auto array2 = new int[3];
f({array2, 3});
```

# Math Libraries

---

## <cmath>

- `fabs(x)` computes absolute value,  $|x|$ , C++11
- `exp(x)` returns e raised to the given power,  $e^x$
- `exp2(x)` returns 2 raised to the given power,  $2^x$ , C++11
- `log(x)` computes natural (base e) logarithm,  $\log_e(x)$
- `log10(x)` computes base 10 logarithm,  $\log_{10}(x)$
- `log2(x)` computes base 2 logarithm,  $\log_2(x)$ , C++11
- `pow(x, y)` raises a number to the given power,  $x^y$
- `sqrt(x)` computes square root,  $\sqrt{x}$
- `cbrt(x)` computes cubic root,  $\sqrt[3]{x}$ , C++11

- `sin(x)` computes sine,  $\sin(x)$
- `cos(x)` computes cosine,  $\cos(x)$
- `tan(x)` computes tangent,  $\tan(x)$
- `ceil(x)` nearest integer not less than the given value,  $\lceil x \rceil$
- `floor(x)` nearest integer not greater than the given value,  $\lfloor x \rfloor$
- `round|lround|llround(x)` nearest integer,  $\lfloor x + \frac{1}{2} \rfloor$   
(return type: floating point, long, long long respectively)

Math functions in C++11 can be applied directly to integral types without implicit/explicit casting (return type: floating point).

[en.cppreference.com/w/cpp/numeric/math](http://en.cppreference.com/w/cpp/numeric/math)

## <limits> Numerical Limits

Get numeric limits of a given type:

<limits> C++11

```
T numeric_limits<T>::max() // returns the maximum finite value
 // value representable
```

```
T numeric_limits<T>::min() // returns the minimum finite value
 // value representable
```

```
T numeric_limits<T>::lowest() // returns the lowest finite
 // value representable
```

# <numeric> Mathematical Constants

<numeric> C++20

The header provides numeric constants

- `e` Euler number  $e$
- `pi`  $\pi$
- `phi` Golden ratio  $\frac{1+\sqrt{5}}{2}$
- `sqrt2`  $\sqrt{2}$



# Integer Division

Integer ceiling division and rounded division:

- **Ceiling Division:**  $\left\lceil \frac{\text{value}}{\text{div}} \right\rceil$

```
unsigned ceil_div(unsigned value, unsigned div) {
 return (value + div - 1) / div;
} // note: may overflow
```

- **Rounded Division:**  $\left\lfloor \frac{\text{value}}{\text{div}} + \frac{1}{2} \right\rfloor$

```
unsigned round_div(unsigned value, unsigned div) {
 return (value + div / 2) / div;
} // note: may overflow
```

Note: do not use floating-point conversion (see Basic Concept I)

# Random Number

---

# Random Number

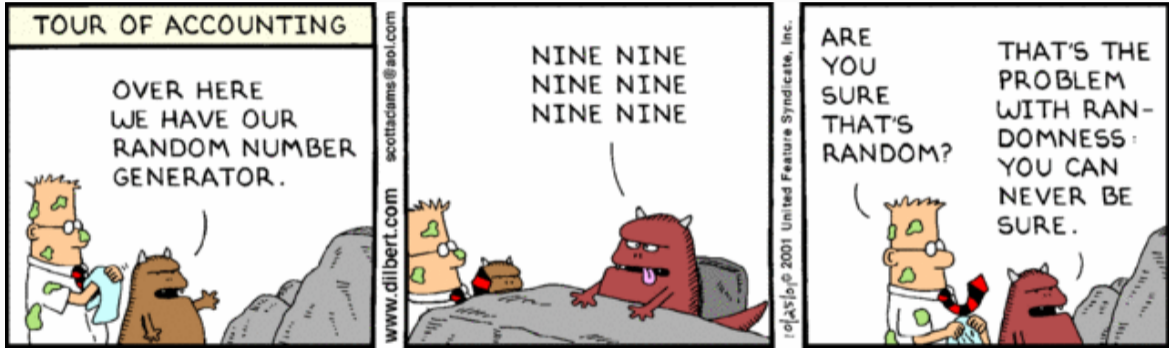

*“Random numbers should not be generated with a method chosen at random”*  
— **Donald E. Knuth**

**Applications:** cryptography, simulations (e.g. Monte Carlo), etc.

# Random Number



see Lavarand

## Basic Concepts

- A **pseudorandom (PRNG)** *sequence of numbers* satisfies most of the statistical properties of a truly random sequence but is generated by a *deterministic* algorithm (deterministic finite-state machine)
- A **quasirandom** *sequence of  $n$ -dimensional points* is generated by a *deterministic* algorithm designed to fill an  $n$ -dimensional space evenly
- The **state** of a PRNG describes the status of the generator (the values of its variables), namely where the system is after a certain amount of transitions
- The **seed** is a value that initializes the *starting state* of a PRNG. The same seed always produces the same sequence of results
- The **offset** of a sequence is used to skip ahead in the sequence
- PRNGs produce **uniformly distributed** values. PRNGs can also generate values according to a probability function (binomial, normal, etc.)

**The problem:** C `rand()` function produces poor quality random numbers

- C++14 discourage the use of `rand()` and `srand()`

C++11 introduces pseudo random number generation (PRNG) facilities to produce random numbers by using combinations of generators and distributions

A random generator requires four steps:

(1) **Select the seed**

(2) **Define the random engine** (optional)

```
<type_of_random_engine> generator(seed)
```

(3) **Define the distribution**

```
<type_of_distribution> distribution(range_start, range_end)
```

(4) **Produce the random number**

```
distribution(generator)
```

Simplest example:

```
#include <iostream>
#include <random>

int main() {
 std::random_device rd;
 std::default_random_engine generator{rd{}};
 std::uniform_int_distribution<int> distribution{0, 9};

 std::cout << distribution(generator); // first random number
 std::cout << distribution(generator); // second random number
}
```

It generates two random integer numbers in the range [0, 9] by using the default random engine

Given a **seed**, the generator produces always the **same sequence**

The seed could be selected randomly by using the current time:

```
#include <random>
#include <chrono>

unsigned seed = std::chrono::system_clock::now()
 .time_since_epoch().count();
std::default_random_engine generator{seed};
```

`chrono::system_clock::now()` returns an object representing the current point in time

`.time_since_epoch().count()` returns the count of ticks that have elapsed since January 1, 1970

(midnight UTC/GMT)

**Problem:** Consecutive calls return *very similar* seeds



**Pseudo seed:** easy to guess, e.g. single source of randomness

**Secure seed:** hard to guess, e.g. multiple sources of randomness

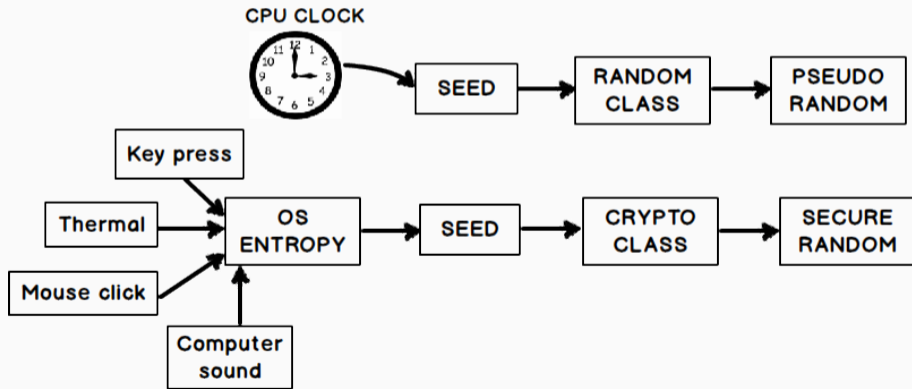

A **random device** `std::random_device` is a uniformly distributed integer generator that produces non-deterministic random numbers, e.g. from a hardware device such as `/dev/urandom`

```
#include <random>

std::random_device rnd_device;
std::default_random_engine generator{rnd_device()};
```

*Note:* Not all OSs provide a random device

`std::seed_seq` consumes a sequence of integer-valued data and produces a number of unsigned integer values in the range  $[0, 2^{32} - 1]$ . The produced values are distributed over the entire 32-bit range even if the consumed values are close

```
#include <random>
#include <chrono>

unsigned seed1 = std::chrono::system_clock::now()
 .time_since_epoch().count();
unsigned seed2 = seed1 + 1000;

std::seed_seq seq1{seed1, seed2};
std::default_random_engine generator1{seq1};
```

# PRNG Period and Quality

## PRNG Period

The **period** (or **cycle length**) of a PRNG is the length of the sequence of numbers that the PRNG generates before repeating

## PRNG Quality

(*informal*) If it is hard to distinguish a generator output from *truly* random sequences, we call it a **high quality** generator. Otherwise, we call it **low quality** generator

| Generator                     | Quality | Period                | Randomness            |
|-------------------------------|---------|-----------------------|-----------------------|
| Linear Congruential           | Poor    | $2^{31} \approx 10^9$ | Statistical tests     |
| Mersenne Twister 32/64-bit    | High    | $10^{6000}$           | Statistical tests     |
| Subtract-with-carry 24/48-bit | Highest | $10^{171}$            | Mathematically proven |

# Randomness Quality

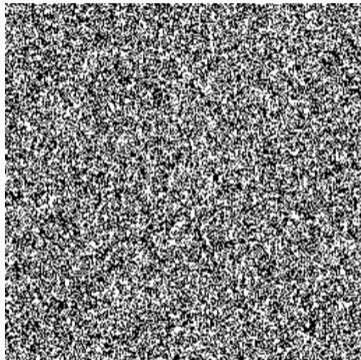

RANDOM.ORG

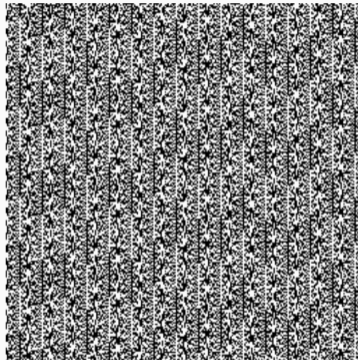

PHP rand() on Microsoft Windows

- 
- On C++ Random Number Generator Quality
  - It is high time we let go of the Mersenne Twister

# Random Engines

- **Linear congruential (LF)**

The simplest generator engine. Modulo-based algorithm:

$x_{i+1} = (\alpha x_i + c) \bmod m$  where  $\alpha, c, m$  are implementation defined

C++ Generators: `std::minstd_rand`, `std::minstd_rand0`,  
`std::knuth_b`

- **Mersenne Twister** (*M. Matsumoto and T. Nishimura, 1997*)

Fast generation of high-quality pseudorandom number. It relies on Mersenne prime number.  
(used as default random generator in linux)

C++ Generators: `std::mt19937`, `std::mt19937_64`

- **Subtract-with-carry (LF)** (*G. Marsaglia and A. Zaman, 1991*)

Pseudo-random generation based on Lagged Fibonacci algorithm (used for example by physicists at CERN)

C++ Generators: `std::ranlux24_base`, `std::ranlux48_base`, `std::ranlux24`, `std::ra`

# Statistical Tests

The table shows after how many iterations the generator fails the statistical tests

| Generator     | 256M | 512M | 1G | 2G | 4G | 8G | 16G | 32G | 64G | 128G | 256G | 512G | 1T |
|---------------|------|------|----|----|----|----|-----|-----|-----|------|------|------|----|
| ranlux24_base | X    | X    | X  | X  | X  | X  | X   | X   | X   | X    | X    | X    | X  |
| ranlux48_base | X    | X    | X  | X  | X  | X  | X   | X   | X   | X    | X    | X    | X  |
| minstd_rand   | X    | X    | X  | X  | X  | X  | X   | X   | X   | X    | X    | X    | X  |
| minstd_rand0  | X    | X    | X  | X  | X  | X  | X   | X   | X   | X    | X    | X    | X  |
| knuth_b       | ✓    | ✓    | X  | X  | X  | X  | X   | X   | X   | X    | X    | X    | X  |
| mt19937       | ✓    | ✓    | ✓  | ✓  | ✓  | ✓  | ✓   | ✓   | ✓   | ✓    | X    | X    | X  |
| mt19937_64    | ✓    | ✓    | ✓  | ✓  | ✓  | ✓  | ✓   | ✓   | ✓   | ✓    | ✓    | X    | X  |
| ranlux24      | ✓    | ✓    | ✓  | ✓  | ✓  | ✓  | ✓   | ✓   | ✓   | ✓    | ✓    | ✓    | ✓  |
| ranlux48      | ✓    | ✓    | ✓  | ✓  | ✓  | ✓  | ✓   | ✓   | ✓   | ✓    | ✓    | ✓    | ✓  |

## Space and Performance

| Generator           | Predictability | State  | Performance |
|---------------------|----------------|--------|-------------|
| Linear Congruential | Trivial        | 4-8 B  | Fast        |
| Knuth               | Trivial        | 1 KB   | Fast        |
| Mersenne Twister    | Trivial        | 2 KB   | Good        |
| randlux_base        | Trivial        | 8-16 B | Slow        |
| randlux             | Unknown?       | ~120 B | Super slow  |



# Distribution

- **Uniform distribution** `uniform_int_distribution<T>(range_start, range_end)`

where T is integral type

`uniform_real_distribution<T>(range_start, range_end)` where T is floating point type

- **Normal distribution**  $P(x) = \frac{1}{\sigma\sqrt{2\pi}} e^{-\frac{(x-\mu)^2}{2\sigma^2}}$

`normal_distribution<T>(mean, std_dev)`

where T is floating point type

- **Exponential distribution**  $P(x, \lambda) = \lambda e^{-\lambda x}$

`exponential_distribution<T>(lambda)`

where T is floating point type

# Examples

```
unsigned seed = ...

// Original linear congruential
minstd_rand0 lc1_generator(seed);
// Linear congruential (better tuning)
minstd_rand lc2_generator(seed);
// Standard mersenne twister (64-bit)
mt19937_64 mt64_generator(seed);
// Subtract-with-carry (48-bit)
ranlux48_base swc48_generator(seed);

uniform_int_distribution<int> int_distribution(0, 10);
uniform_real_distribution<float> real_distribution(-3.0f, 4.0f);
exponential_distribution<float> exp_distribution(3.5f);
normal_distribution<double> norm_distribution(5.0, 2.0);
```

# Recent Algorithms and Performance

## Recent algorithms:

- PCG, A Family of Better Random Number Generators
- Xoshiro / Xoroshiro generators and the PRNG shootout
- The Xorshift128+ random number generator fails BigCrush

## Parallel algorithms:

- Squares: A Fast Counter-Based RNG
- Parallel Random Numbers: As Easy as 1, 2, 3 (Philox)
- OpenRNG: New Random Number Generator Library for best performance when porting to Arm

If strong random number quality properties are not needed, it is possible to generate a random permutation of integer values (with period of  $2^{32}$ ) in a very efficient way by using hashing functions Hash Function Prospector [↗](#)

# Performance Comparison

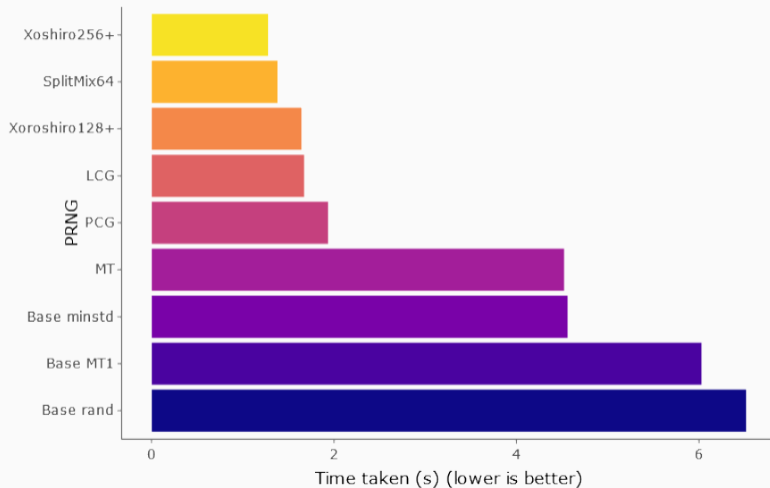

The **quasi-random** numbers have the low-discrepancy property that is a measure of *uniformity for the distribution* of the point for the multi-dimensional case

- Quasi-random sequence, in comparison to pseudo-random sequence, distributes evenly, namely this leads to spread the number over the entire region
- The concept of low-discrepancy is associated with the property that the successive numbers are added in a position as away as possible from the other numbers that is, avoiding *clustering* (grouping of numbers close to each other)

## Pseudo-random vs. Quasi random

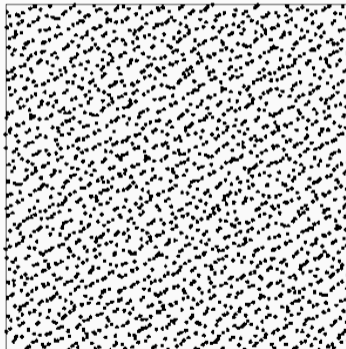
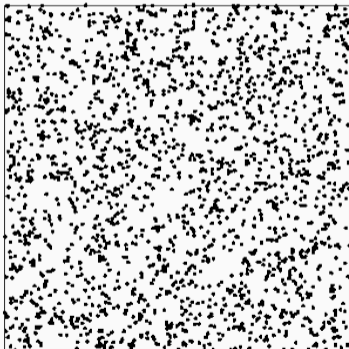

# Time Measuring

---

## Wall-Clock/Real time

It is the human perception of the passage of time from the start to the completion of a task

## User/CPU time

The amount of time spent by the CPU to compute in user code

## System time

The amount of time spent by the CPU to compute system calls (including I/O calls) executed into kernel code



The *Wall-clock time* measured on a concurrent process platform may include the time elapsed for other tasks

The *User/CPU time* of a multi-thread program is the sum of the execution time of all threads

If the system workload (except the current program) is very low and the program uses only one thread then

Wall-clock time = User time + System time

`::gettimeofday()` : time resolution  $1\mu s$

```
#include <time.h> //struct timeval
#include <sys/time.h> //gettimeofday()

struct timeval start, end; // timeval {second, microseconds}
::gettimeofday(&start, NULL);
... // code
::gettimeofday(&end, NULL);

long start_time = start.tv_sec * 1000000 + start.tv_usec;
long end_time = end.tv_sec * 1000000 + end.tv_usec;
cout << "Elapsed: " << end_time - start_time; // in microsec
```

**Problems:** Linux only (not portable), the time is not monotonic increasing (timezone), time resolution is big

## std::chrono C++11

```
#include <chrono>
auto start_time = std::chrono::system_clock::now();
... // code
auto end_time = std::chrono::system_clock::now();

std::chrono::duration<double> diff = end_time - start_time;
cout << "Elapsed: " << diff.count(); // in seconds
cout << std::chrono::duration_cast<milli>(diff).count(); // in ms
```

**Problems:** The time is not monotonic increasing (timezone)

An alternative of `system_clock` is `steady_clock` which ensures monotonic increasing time.

`steady_clock` is implemented over `clock_gettime` on POSIX system and has *1ns* time resolution

```
#include <chrono>
auto start_time = std::chrono::steady_clock::now();
... // code
auto end_time = std::chrono::steady_clock::now();
```

However, the overhead of C++ API is not always negligible, e.g.  
Linux libstdc++ → 20ns, Mac libc++ → 41ns

## Time Measuring - User Time

`std::clock`, implemented over `clock_gettime` on POSIX system and has *1ns* time resolution

```
#include <chrono>

clock_t start_time = std::clock();
... // code
clock_t end_time = std::clock();

float diff = static_cast<float>(end_time - start_time) / CLOCKS_PER_SEC;
cout << "Elapsed: " << diff; // in seconds
```

## Time Measuring - User/System Time

```
#include <sys/times.h>

struct ::tms start_time, end_time;
::times(&start_time);
... // code
::times(&end_time);

auto user_diff = end_time.tmus_utime - start_time.tms_utime;
auto sys_diff = end_time.tms_stime - start_time.tms_stime;
float user = static_cast<float>(user_diff) / ::sysconf(_SC_CLK_TCK);
float sys = static_cast<float>(sys_diff) / ::sysconf(_SC_CLK_TCK);
cout << "user time: " << user; // in seconds
cout << "system time: " << sys; // in seconds
```

# Std Classes

---

<utility>

`std::pair` class couples together a pair of values, which may be of different types

Construct a `std::pair`

- `std::pair<T1, T2> pair(value1, value2)`
- `std::pair<T1, T2> pair = {value1, value2}`
- `auto pair = std::make_pair(value1, value2)`

Data members:

- `first` access first field
- `second` access second field

Methods:

- comparison `==, <, >, ≥, ≤`
- swap `std::swap`



```
#include <utility>

std::pair<int, std::string> pair1(3, "abc");
std::pair<int, std::string> pair2 = { 4, "zzz" };
auto pair3 = std::make_pair(3, "hgt");

cout << pair1.first; // print 3
cout << pair1.second; // print "abc"

swap(pair1, pair2);
cout << pair2.first; // print "zzz"
cout << pair2.second; // print 4

cout << (pair1 > pair2); // print 1
```

<tuple>

`std::tuple` is a fixed-size collection of heterogeneous values. It is a generalization of `std::pair`. It allows any number of values

Construct a `std::tuple` (of size 3)

- `std::tuple<T1, T2, T3> tuple(value1, value2, value3)`
- `std::tuple<T1, T2, T3> tuple = {value1, value2, value3}`
- `auto tuple = std::make_tuple(value1, value2, value3)`

Data members:

`std::get<I>(tuple)` returns the *i*-th value of the tuple

Methods:

- comparison `==, <, >, ≥, ≤`
- swap `std::swap`

- `auto t3 = std::tuple_cat(t1, t2)`  
concatenate two tuples
- `const int size = std::tuple_size<TupleT>::value`  
returns the number of elements in a tuple at compile-time
- `using T = typename std::tuple_element<TupleT>::type` obtains the type of the specified element
- `std::tie(value1, value2, value3) = tuple`  
creates a tuple of references to its arguments
- `std::ignore`  
an object of unspecified type such that any value can be assigned to it with no effect

```
#include <tuple>
std::tuple<int, float, char> f() { return {7, 0.1f, 'a'}; }

std::tuple<int, char, float> tuple1(3, 'c', 2.2f);
auto tuple2 = std::make_tuple(2, 'd', 1.5f);

cout << std::get<0>(tuple1); // print 3
cout << std::get<1>(tuple1); // print 'c'
cout << std::get<2>(tuple1); // print 2.2f
cout << (tuple1 > tuple2); // print true

auto concat = std::tuple_cat(tuple1, tuple2);
cout << std::tuple_size<decltype(concat)>::value; // print 6

using T = std::tuple_element<4, decltype(concat)>::type; // T is int
int value1; float value2;
std::tie(value1, value2, std::ignore) = f();
```

<variant> C++17

`std::variant` represents a **type-safe union** as the corresponding objects know which type is currently being held

It can be indexed by:

- `std::get<index>(variant)` an integer
- `std::get<type>(variant)` a type

```
#include <variant>

std::variant<int, float, bool> v(3.3f);
int x = std::get<0>(v); // return integer value
bool y = std::get<bool>(v); // return bool value
// std::get<0>(v) = 2.0f; // run-time exception!!
```

Another useful method is `index()` which returns the position of the type currently held by the variant

```
#include <variant>

std::variant<int, float, bool> v(3.3f);

cout << v.index(); // return 1

std::get<bool>(v) = true
cout << v.index(); // return 2
```

It is also possible to query the index at run-time depending on the type currently being held by providing a **visitor**

```
#include <variant>

struct Visitor {
 void operator()(int& value) { value *= 2; }

 void operator()(float& value) { value += 3.0f; } // <--

 void operator()(bool& value) { value = true; }
};

std::variant<int, float, bool> v(3.3f);

std::visit(v, Visitor{});

cout << std::get<float>(v); // 6.3f
```

<optional> C++17

std::optional provides facilities to represent potential “no value” states

As an example, it can be used for representing the state when an element is not found in a set

```
#include <optional>

std::optional<std::string> find(const char* set, char value) {
 for (int i = 0; i < 10; i++) {
 if (set[i] == value)
 return i;
 }
 return {}; // std::nullopt;
}
```



```
#include <optional>

char set[] = "sdfslgfsdg";
auto x = find(set, 'a'); // 'a' is not present
if (!x)
 cout << "not found";
if (!x.has_value())
 cout << "not found";

auto y = find(set, 'l');
cout << *y << " " << y.value(); // print '4' '4'

x.value_or(-1); // returns '-1'
y.value_or(-1); // returns '4'
```

<any> C++17

std::any holds arbitrary values and provides **type-safety**

```
#include <any>

std::any var = 1; // int
cout << var.type().name(); // print 'i'

cout << std::any_cast<int>(var);
// cout << std::any_cast<float>(var); // exception!!

var = 3.14; // double
cout << std::any_cast<double>(var);

var.reset();
cout << var.has_value(); // print 'false'
```

C++23 introduces `std::stacktrace` library to get the current function call stack, namely the sequence of calls from the `main()` entry point

```
#include <print>
#include <stacktrace> // the program must be linked with the library
 // -lstdc++_libbacktrace
 // (-lstdc++exp with gcc-14 trunk)

void g() {
 auto call_stack = std::stacktrace::current();
 for (const auto& entry : call_stack)
 std::print("{}\n", entry);
}

void f() { g(); }

int main() { f(); }
```

the previous code prints

```
g() at /app/example.cpp:6
f() at /app/example.cpp:11
main at /app/example.cpp:13
 at :0
__libc_start_main at :0
_start at :0
```

The library also provides additional functions for `entry` to allow fine-grained control of the output `description()`, `source_file()`, `source_line()`

```
for (const auto& entry : call_stack) { // same output
 std::print("{} at {}:{}\n", entry.description(), entry.source_file(),
 entry.source_line());
}
```

# Filesystem Library

---

C++17 introduces abstractions and facilities for performing operations on file systems and their components, such as **paths**, **files**, and **directories**

- Follow the Boost filesystem library
- Based on POSIX
- Fully-supported from clang 7, gcc 8, etc.
- Work on Windows, Linux, Android, etc.

# Basic concepts

- **file**: a file system object that holds data
  - **directory** a container of directory entries
  - **hard link** associates a name with an existing file
  - **symbolic link** associates a name with a path
  - **regular file** a file that is not one of the other file types
- **file name**: a string of characters that names a file. Names `.` (dot) and `..` (dot-dot) have special meaning at library level
- **path**: sequence of elements that identifies a file
  - **absolute path**: a path that unambiguously identifies the location of a file
  - **canonical path**: an absolute path that includes no symlinks, `.` or `..` elements
  - **relative path**: a path that identifies a file relative to some location on the file system

# path Object

A `path` object stores the pathname in native form

```
#include <filesystem> // required
namespace fs = std::filesystem;

fs::path p1 = "/usr/lib/sendmail.cf"; // portable format
fs::path p2 = "C:\\users\\abcdef\\"; // native format

cout << "p1: " << p1; // /usr/lib/sendmail.cf
cout << "p2: " << p2; // C:\users\abcdef\

out << "p3: " << p2 + "xyz\\"; // C:\users\abcdef\xyz\
```



Decomposition (member) methods:

- **Return root-name of the path**

```
root_name()
```

- **Return path relative to the root path**

```
relative_path()
```

- **Return the path of the parent path**

```
parent_path()
```

- **Return the filename path component**

```
filename()
```

- **Return the file extension path component**

```
extension()
```

## Filesystem Methods - Query

- Check if a file or path exists  
`exists(path)`
- Return the file size  
`file_size(path)`
- Check if a file is a directory  
`is_directory(path)`
- Check if a file (or directory) is empty  
`is_empty(path)`
- Check if a file is a regular file  
`is_regular_file(path)`
- Returns the current path  
`current_path()`

# Directory Iterators

Iterate over files of a directory (recursively/non-recursively)

```
#include <filesystem>

namespace fs = std::filesystem;

for(auto& path : fs::directory_iterator("/usr/tmp/"))
 cout << path << '\n';

for(auto& path : fs::recursive_directory_iterator("/usr/tmp/"))
 cout << path << '\n';
```

## Filesystem Methods - Modify

- **Copy files or directories**

```
copy(path1, path2)
```

- **Copy files**

```
copy_file(src_path, src_path, [fs::copy_options::recursive])
```

- **Create new directory**

```
create_directory(path)
```

- **Remove a file or empty directory**

```
remove(path)
```

- **Remove a file or directory and all its contents, recursively**

```
remove_all(path)
```

- **Rename a file or directory**

```
rename(old_path, new_path)
```

# Examples

```
#include <filesystem> // required

namespace fs = std::filesystem;
fs::path p1 = "/usr/tmp/my_file.txt";

cout << p1.exists(); // true
cout << p1.parent_path(); // "/usr/tmp/"
cout << p1.filename(); // "my_file"
cout << p1.extension(); // ".txt"
cout << p1.is_directory(); // false
cout << p1.is_regular_file(); // true

fs::create_directory("/my_dir/");
fs::copy(p1.parent_path(), "/my_dir/", fs::copy_options::recursive);
fs::copy_file(p1, "/my_dir/my_file2.txt");
fs::remove(p1);
fs::remove_all(p1.parent_path());
```

# Modern C++ Programming

## 18. CONTAINERS, ITERATORS, RANGES, AND ALGORITHMS

---

*Federico Busato*

2024-11-05

## 1 Containers and Iterators

- Semantic

## 2 Sequence Containers

- `std::array`
- `std::vector`
- `std::deque`
- `std::list`
- `std::forward_list`

## 3 Associative Containers

- `std::set`
- `std::map`
- `std::multiset`

## 4 Container Adaptors

- `std::stack`, `std::queue`, `std::priority_queue`

## 5 Implement a Custom Iterator

- Implement a Simple Iterator



## 6 Iterator Notes

## 7 Iterator Utility Methods

- `std::advance`, `std::next`
- `std::prev`, `std::distance`
- Container Access Methods
- Iterator Traits

## 8 Algorithms Library

- `std::find_if`, `std::sort`
- `std::accumulate`, `std::generate`, `std::remove_if`

## 9 C++20 Ranges

- Key Concepts
- Range View
- Range Adaptor
- Range Factory
- Range Algorithms
- Range Actions

# Containers and Iterators

---

## Container

A **container** is a class, a data structure, or an abstract data type, whose instances are collections of other objects

- *Containers* store objects following specific access rules

## Iterator

An **iterator** is an object allowing to traverse a container

- *Iterators* are a generalization of pointers
- A pointer is the simplest *iterator*, and it supports all its operations

**C++ Standard Template Library (STL)** is strongly based on *containers* and *iterators*

## Reasons to use Standard Containers

- STL containers eliminate redundancy, and save time avoiding writing your own code (productivity)
- STL containers are implemented correctly, and they do not need to spend time to debug (reliability)
- STL containers are well-implemented and fast
- STL containers do not require external libraries
- STL containers share common interfaces, making it simple to utilize different containers without looking up member function definitions
- STL containers are well-documented and easily understood by other developers, improving the understandability and maintainability
- STL containers are thread safe. Sharing objects across threads preserve the consistency of the container

# Container Properties

**C++ Standard Template Library (STL) Containers** have the following properties:

- Default constructor
- Destructor
- Copy constructor and assignment (deep copy)
- Iterator methods `begin()`, `end()`
- Support `std::swap`
- Content-based and order equality (`==`, `!=`)
- Lexicographic order comparison (`>`, `>=`, `<`, `<=`)
- `size()`\*, `empty()`, and `max_size()` methods

\* except for `std::forward_list`

# Iterator Concept

**STL containers** provide the following methods to get iterator objects:

- `begin()` returns an iterator pointing to the first element
- `end()` returns an iterator pointing to the end of the container (i.e. the element after the last element)

There are different categories of **iterators** and each of them supports a subset of the following operations:

| Operation     | Example                    |
|---------------|----------------------------|
| Read          | <code>*it</code>           |
| Write         | <code>*it =</code>         |
| Increment     | <code>it++</code>          |
| Decrement     | <code>it--</code>          |
| Comparison    | <code>it1 &lt; it2</code>  |
| Random access | <code>it + 4, it[2]</code> |



# Iterator Categories/Tags

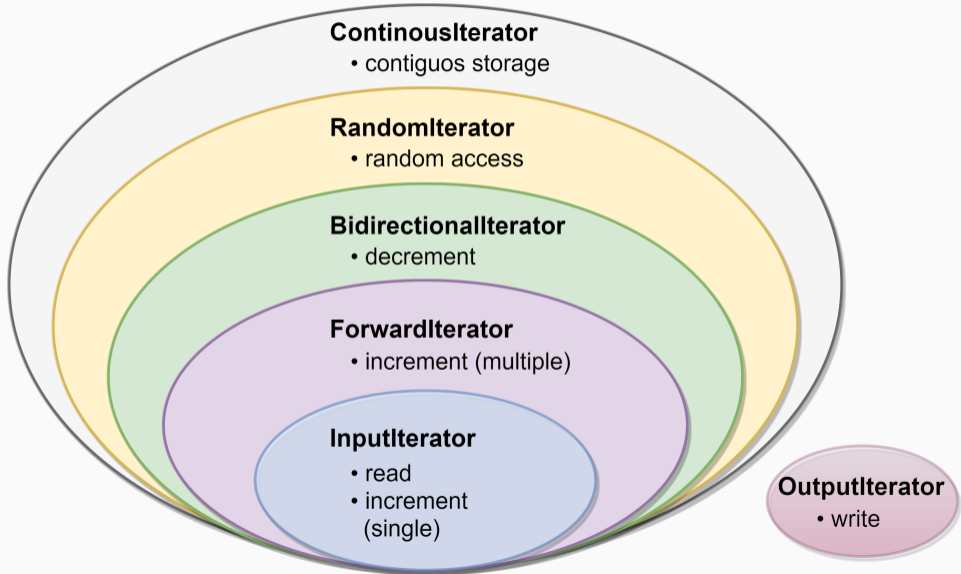

## Iterator

- Copy Constructible `It(const It&)`
- Copy Assignable `It operator=(const It&)`
- Destructible `~X()`
- Dereferenceable `It_value& operator*()`
- Pre-incrementable `It& operator++()`

## Input/Output Iterator

- Satisfy Iterator
- Equality `bool operator==(const It&)`
- Inequality `bool operator!=(const It&)`
- Post-incrementable `It operator++(int)`

## Forward Iterator

- Satisfy Input/Output Iterator
- Default constructible `It()`

## Bidirectional Iterator

- Satisfy Forward Iterator
- Pre/post-decrementable `It& operator--()`, `It operator--(int)`

## Random Access Iterator

- Satisfy Bidirectional Iterator
- Addition/Subtraction  
`void operator+(const It& it)`, `void operator+=(const It& it)`,  
`void operator-(const It& it)`, `void operator-=(const It& it)`
- Comparison  
`bool operator<(const It& it)`, `bool operator>(const It& it)`,  
`bool operator<=(const It& it)`, `bool operator>=(const It& it)`
- Subscripting `It_value& operator[](int index)`

# Sequence Containers

---

**Sequence containers** are data structures storing objects of the same data type in a linear mean manner

The *STL Sequence Container* types are:

- `std::array` provides a *fixed-size* contiguous array (on stack)
- `std::vector` provides a *dynamic* contiguous array (`constexpr` in C++20)
- `std::list` provides a *double-linked list*
- `std::deque` provides a *double-ended queue* (implemented as array-of-array)
- `std::forward_list` provides a *single-linked list*

While `std::string` is not included in most container lists, it actually meets the requirements of a Sequence Container

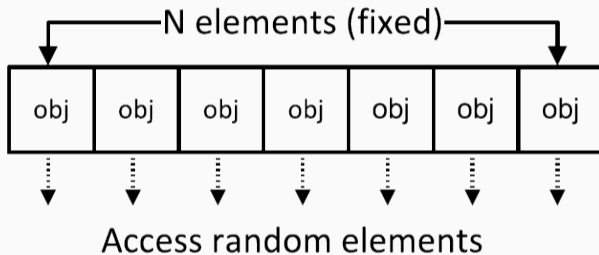

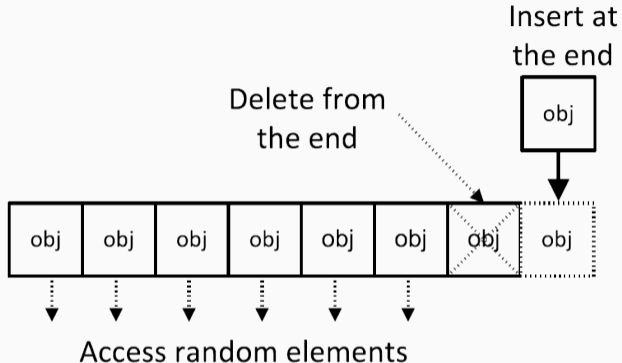

#### Other methods:

- `resize()` resizes the allocated elements of the container
- `capacity()` number of allocated elements
- `reserve()` resizes the allocated memory of the container (not size)
- `shrink_to_fit()` reallocate to remove unused capacity
- `clear()` removes all elements from the container (no reallocation)

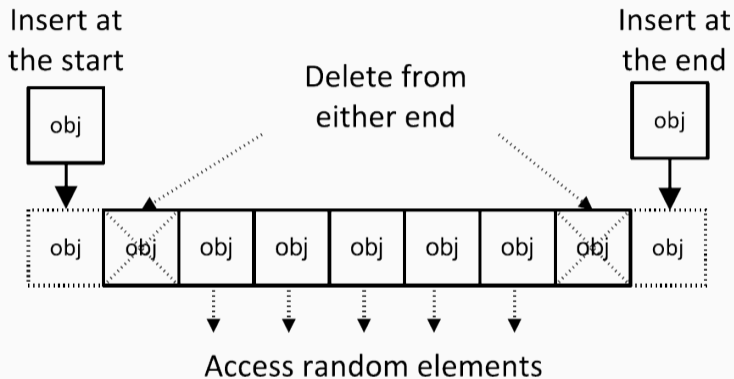

#### Other methods:

- `resize()` resizes the allocated elements of the container
- `shrink_to_fit()` reallocate to remove unused capacity
- `clear()` removes all elements from the container (no reallocation)



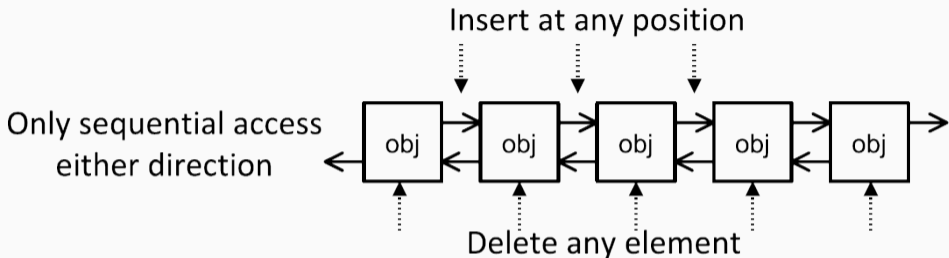

#### Other methods:

- `resize()` resizes the allocated elements of the container
- `shrink_to_fit()` reallocate to remove unused capacity
- `clear()` removes all elements from the container (no reallocation)
- `remove()` removes all elements satisfying specific criteria
- `reverse()` reverses the order of the elements
- `unique()` removes all consecutive duplicate elements
- `sort()` sorts the container elements

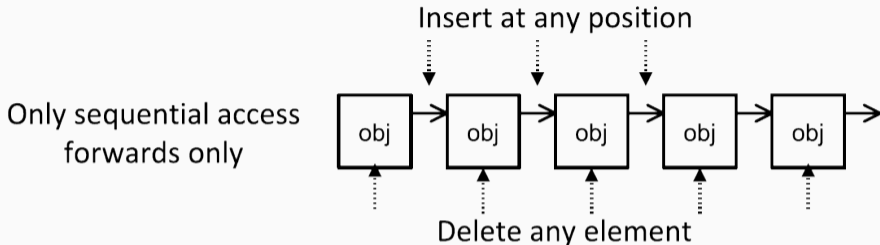

### Other methods:

- `resize()` resizes the allocated elements of the container
- `shrink_to_fit()` reallocate to remove unused capacity
- `clear()` removes all elements from the container (no reallocation)
- `remove()` removes all elements satisfying specific criteria
- `reverse()` reverses the order of the elements
- `unique()` removes all consecutive duplicate elements
- `sort()` sorts the container elements

## Supported Operations and Complexity

| CONTAINERS        | operator[]/at | front  | back   |
|-------------------|---------------|--------|--------|
| std::array        | $O(1)$        | $O(1)$ | $O(1)$ |
| std::vector       | $O(1)$        | $O(1)$ | $O(1)$ |
| std::list         |               | $O(1)$ | $O(1)$ |
| std::deque        | $O(1)$        | $O(1)$ | $O(1)$ |
| std::forward_list |               | $O(1)$ |        |

| CONTAINERS        | push_front | pop_front | push_back | pop_back | insert(it)            | erase(it) |
|-------------------|------------|-----------|-----------|----------|-----------------------|-----------|
| std::array        |            |           |           |          |                       |           |
| std::vector       |            |           | $O(1)^*$  | $O(1)^*$ | $O(n)$                | $O(n)$    |
| std::list         | $O(1)$     | $O(1)$    | $O(1)$    | $O(1)$   | $O(1)$                | $O(1)$    |
| std::deque        | $O(1)^*$   | $O(1)$    | $O(1)$    | $O(1)$   | $O(1)^*/O(n)^\dagger$ | $O(1)$    |
| std::forward_list | $O(1)$     | $O(1)$    |           |          | $O(1)$                | $O(1)$    |

\* Amortized time

† Worst case (middle insertion)

## std::array example

```
#include <algorithm> // std::sort
#include <array>
// std::array supports initialization only through initialization list
std::array<int, 3> arr1 = { 5, 2, 3 };
std::array<int, 4> arr2 = { 1, 2 }; // [3]: 0, [4]: 0
// std::array<int, 3> arr3 = { 1, 2, 3, 4 }; // compiler error
std::array<int, 3> arr4(arr1); // copy constructor
std::array<int, 3> arr5 = arr1; // assign operator

arr5.fill(3); // equal to { 3, 3, 3 }
std::sort(arr1.begin(), arr1.end()); // arr1: 2, 3, 5
cout << (arr1 >= arr5); // true

cout << sizeof(arr1); // 12
cout << arr1.size(); // 3
for (const auto& it : arr1)
 cout << it << ", "; // 2, 3, 5
cout << arr1[0]; // 2
cout << arr1.at(0); // 2, throw if the index is not within the range
cout << arr1.data()[0]; // 2 (raw array)
```

## std::vector example

```
#include <vector>

std::vector<int> vec1 { 2, 3, 4 };
std::vector<std::string> vec2 = { "abc", "efg" };
std::vector<int> vec3(2); // [0, 0]
std::vector<int> vec4{2}; // [2]
std::vector<int> vec5(5, -1); // [-1, -1, -1, -1, -1]

fill(vec5.begin(), vec5.end(), 3); // equal to { 3, 3, 3, 3, 3 }
cout << sizeof(vec1); // 24
cout << vec1.size(); // 3
for (const auto& it : vec1)
 std::cout << it << ", "; // 2, 3, 4

cout << vec1[0]; // 2
cout << vec1.at(0); // 2 (bound check)
cout << vec1.data()[0]; // 2 (raw array)
vec1.push_back(5); // [2, 3, 4, 5]
```

## std::list example

```
#include <list>

std::list<int> list1 { 2, 3, 2 };
std::list<std::string> list2 = { "abc", "efg" };
std::list<int> list3(2); // [0, 0]
std::list<int> list4{2}; // [2]
std::list<int> list5(2, -1); // [-1, -1]
std::fill(list5.begin(), list5.end(), 3); // [3, 3]

list1.push_back(5); // [2, 3, 2, 5]
list1.sort(); // [2, 2, 3, 5]
list1.merge(list5); // [-1, -1, 2, 2, 3, 5] merge two sorted lists
list1.remove(2); // [-1, -1, 3, 5]
list1.unique(); // [-1, 3, 5]
list1.reverse(); // [5, 3, -1]
```

## std::deque example

```
#include <deque>

std::deque<int> queue1 { 2, 3, 2 };
std::deque<std::string> queue2 = { "abc", "efg" };
std::deque<int> queue3(2); // [0, 0]
std::deque<int> queue4{2}; // [2]
std::deque<int> queue5(2, -1); // [-1, -1]
std::fill(queue5.begin(), queue5.end(), 3); // [3, 3]

queue1.push_front(5); // [5, 2, 3, 2]
queue1[0]; // returns 5
```

## std::forward\_list example

```
#include <forward_list>

std::forward_list<int> flist1 { 2, 3, 2 };
std::forward_list<std::string> flist2 = { "abc", "efg" };
std::forward_list<int> flist3(2); // [0, 0]
std::forward_list<int> flist4{2}; // [2]
std::forward_list<int> flist5(2, -1); // [-1, -1]
std::fill(flist5.begin(), flist5.end(), 4); // [4, 4]

flist1.push_front(5); // [5, 2, 3, 2]
flist1.insert_after(flist1.begin(), 0); // [5, 0, 2, 3, 2]
flist1.erase_after(flist1.begin()); // [5, 2, 3, 2]
flist1.remove(2); // [5, 3, 3]
flist1.unique(); // [5, 3]
flist1.reverse(); // [3, 5]
flist1.sort(); // [3, 5]
flist1.merge(flist5); // [3, 4, 4, 5] merge two sorted lists
```



# Associative Containers

---

# Overview

An **associative container** is a collection of elements not necessarily indexed with sequential integers and that supports efficient retrieval of the stored elements through keys

## Keys are unique

- `std::set` is a collection of sorted unique elements (`operator<`)
- `std::unordered_set` is a collection of unsorted unique keys
- `std::map` is a collection of unique `<key, value>` pairs, sorted by keys
- `std::unordered_map` is a collection of unique `<key, value>` pairs, unsorted

## Multiple entries for the same key are permitted

- `std::multiset` is a collection of sorted elements (`operator<`)
- `std::unordered_multiset` is a collection of unsorted elements
- `std::multimap` is a collection of `<key, value>` pairs, sorted by keys

# Internal Representation

Sorted associative containers are typically implemented using *red-black trees*, while unordered associative containers (C++11) are implemented using *hash tables*

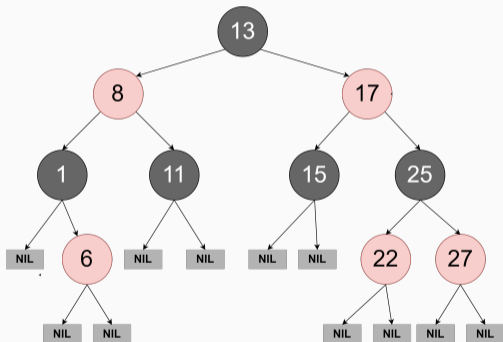

Red-Black Tree

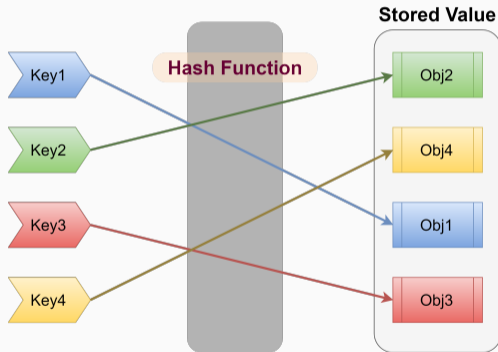

Hash Table

Hash Table

## Supported Operations and Complexity

| CONTAINERS           | <i>insert</i>          | <i>erase</i>           | <i>count</i>           | <i>find</i>            | <i>lower_bound</i><br><i>upper_bound</i> |
|----------------------|------------------------|------------------------|------------------------|------------------------|------------------------------------------|
| Ordered Containers   | $\mathcal{O}(\log(n))$ | $\mathcal{O}(\log(n))$ | $\mathcal{O}(\log(n))$ | $\mathcal{O}(\log(n))$ | $\mathcal{O}(\log(n))$                   |
| Unordered Containers | $\mathcal{O}(1)^*$     | $\mathcal{O}(1)^*$     | $\mathcal{O}(1)^*$     | $\mathcal{O}(1)^*$     |                                          |

\*  $\mathcal{O}(n)$  worst case

- `count()` returns the number of elements with `key` equal to a specified argument
- `find()` returns the element with `key` equal to a specified argument
- `lower_bound()` returns an iterator pointing to the first element that is *not less* than `key`
- `upper_bound()` returns an iterator pointing to the first element that is *greater* than `key`

## Other Methods

### Ordered/Unordered containers:

- `equal_range()` returns a range containing all elements with the given `key`

### `std::map`, `std::unordered_map`

- `operator[]/at()` returns a reference to the element having the specified key in the container. A new element is generated in the set unless the key is found

### Unordered containers:

- `bucket_count()` returns the number of buckets in the container
- `reserve()` sets the number of buckets to the number needed to accommodate at least `count` elements without exceeding maximum load factor and rehashes the container

## std::set example

```
#include <set>

std::set<int> set1 { 5, 2, 3, 2, 7 };
std::set<int> set2 = { 2, 3, 2 };
std::set<std::string> set3 = { "abc", "efg" };
std::set<int> set4; // empty set

set2.erase(2); // [3]
set3.insert("hij"); // ["abc", "efg", "hij"]
for (const auto& it : set1)
 cout << it << " "; // 2, 3, 5, 7 (sorted)

auto search = set1.find(2); // iterator
cout << search != set1.end(); // true
auto it = set1.lower_bound(4);
cout << *it; // 5
set1.count(2); // 1, note: it can only be 0 or 1
auto it_pair = set1.equal_range(2); // iterator between [2, 3)
```

## std::map example

```
#include <map>

std::map<std::string, int> map1 { {"bb", 5}, {"aa", 3} };
std::map<double, int> map2; // empty map

cout << map1["aa"]; // prints 3
map1["dd"] = 3; // insert <"dd", 3>
map1["dd"] = 7; // change <"dd", 7>
cout << map1["cc"]; // insert <"cc", 0>
for (const auto& it : map1)
 cout << it.second << " "; // 3, 5, 0, 7

map1.insert({"jj", 1}); // insert pair
auto search = map1.find("jj"); // iterator
cout << (search != map1.end()); // true
auto it = map1.lower_bound("bb");
cout << (*it).second; // 5
```

## std::multiset example

```
#include <set> // std::multiset

std::multiset<int> mset1 {1, 2, 5, 2, 2}; // 1, 2, 2, 2, 5
std::multiset<double> mset2; // empty set

mset1.insert(5);
for (const auto& it : mset1)
 cout << it << " "; // 1, 2, 2, 2, 5, 5
cout << mset1.count(2); // 3

auto it = mset1.find(5); // iterator
cout << *it; // 5

it = mset1.lower_bound(4);
cout << *it; // 5
```



# Container Adaptors

---

**Container adaptors** are interfaces for reducing the number of functionalities normally available in a container

The underlying container of a container adaptors can be optionally specified in the declaration

The *STL Container Adaptors* are:

- `std::stack` LIFO data structure  
default underlying container: `std::deque`
- `std::queue` FIFO data structure  
default underlying container: `std::deque`
- `std::priority_queue` (max) priority queue  
default underlying container: `std::vector`

## Container Adaptors Methods

`std::stack` interface for a FILO (first-in, last-out) data structure

- `top()` accesses the top element
- `push()` inserts element at the top
- `pop()` removes the top element

`std::queue` interface for a FIFO (first-in, first-out) data structure

- `front()` access the first element
- `back()` access the last element
- `push()` inserts element at the end
- `pop()` removes the first element

`std::priority_queue` interface for a priority queue data structure (lookup to the largest element by default)

- `top()` accesses the top element
- `push()` inserts element at the end
- `pop()` removes the first element

# Container Adaptor Examples

```
#include <stack> // <--
#include <queue> // <-- also include priority_queue

std::stack<int> stack1;
stack1.push(1); stack1.push(4); // [1, 4]
stack1.top(); // 4
stack1.pop(); // [1]

std::queue<int> queue1;
queue1.push(1); queue1.push(4); // [1, 4]
queue1.front(); // 1
queue1.pop(); // [4]

std::priority_queue<int> pqueue1;
pqueue1.push(1); pqueue1.push(5); pqueue1.push(4); // [5, 4, 1]
pqueue1.top(); // 5
pqueue1.pop(); // [4, 1]
```

# Implement a Custom Iterator

---

**Goal:** implement a simple iterator to iterate over a `List` of elements:

```
#include <iostream>
#include <algorithm>
// !! List implementation here

int main() {
 List list;
 list.push_back(2);
 list.push_back(4);
 list.push_back(7);
 std::cout << *std::find(list.begin(), list.end(), 4); // print 4

 for (const auto& it : list) // range-based loop
 std::cout << it << " "; // 2, 4, 7
}
```

Range-based loops require: `begin()`, `end()`, pre-increment `++it`, not equal comparison `it != end()`, dereferencing `*it`

```
using value_t = int;

struct List {
 struct Node { // Internal Node Structure
 value_t _value; // Node value
 Node* _next; // Pointer to next node
 };
 Node* _head { nullptr }; // head of the list
 Node* _tail { nullptr }; // tail of the list

 void push_back(const value_t& value); // insert a value at the end

 // !! here we have to define the List iterator "It"

 It begin() { return It{_head}; } // begin of the list
 It end() { return It{nullptr}; } // end of the list
};
```

```
void List::push_back(const value_t& value) {
 auto new_node = new Node{value, nullptr};
 if (_head == nullptr) { // empty list
 _head = new_node; // head is updated
 _tail = _head;
 return;
 }
 assert(_tail != nullptr);
 _tail->_next = new_node; // add new node at the end
 _tail = new_node; // tail is updated
}
```



```
struct It {
 Node* _ptr; // internal pointer

 It(Node* ptr); // Constructor

 value_t& operator*(); // Deferencing

 // Not equal -> stop traversing
 friend bool operator!=(const It& itA, const It& itB);

 It& operator++(); // Pre-increment

 It operator++(int); // Post-increment

 // !! Type traits here
};
```

```
List::It::It(Node* ptr) :_ptr(ptr) {}

value_t& Lis::It::operator*() { return _ptr->_value; }

bool operator!=(const It& itA, const It& itB) {
 return itA._ptr != itB._ptr;
}

List::It& List::It::operator++() {
 _ptr = _ptr->_next;
 return *this;
}

List::It List::It::operator++(int) {
 auto tmp = *this;
 ++(*this);
 return tmp;
}
```

The *type traits* of an iterator describe its properties, e.g. the type of the value held, and they are widely used in the `std` algorithms

`std::iterator` class template defines the type traits for an iterator. It has been deprecated in C++17, so users need to provide the type traits explicitly

```
#include <iterator>

// !! Type traits
using iterator_category = std::forward_iterator_tag;
using difference_type = std::ptrdiff_t;
using value_type = value_t;
using pointer = value_t*;
using reference = value_t&;
```

# Iterator Notes

---

Modify a container with a “active” iterators

```
#include <vector>

std::vector<int> vec{1, 2, 3, 4, 5};
for (auto x : vec)
 vec.push_back(x); // iterator invalidation!!
```

# Iterator Utility Methods

---

- `std::advance`(InputIt& it, Distance n)

Increments a given iterator it by n elements

- InputIt must support input iterator requirements
- Modifies the iterator
- Returns void
- More general than adding a value `it + 4`
- No performance loss if it satisfies random access iterator requirements

- `std::next`(ForwardIt it, Distance n) C++11

Returns the n-th successor of the iterator

- ForwardIt must support forward iterator requirements
- Does not modify the iterator
- More general than adding a value `it + 4`
- The compiler should optimize the computation if it satisfies random access iterator requirements
- Supports negative values if it satisfies bidirectional iterator requirements

- `std::prev`(BidirectionalIt it, Distance n) C++11

Returns the n-th predecessor of the iterator

- `InputIt` must support bidirectional iterator requirements
- Does not modify the iterator
- More general than adding a value `it + 4`
- The compiler should optimize the computation if `it` satisfies random access iterator requirements

- `std::distance`(InputIt start, InputIt end)

Returns the number of elements from start to last

- `InputIt` must support input iterator requirements
- Does not modify the iterator
- More general than adding iterator difference `it2 - it1`
- The compiler should optimize the computation if `it` satisfies random access iterator requirements
- C++11 Supports negative values if `it` satisfies random iterator requirements



# Examples

```
#include <iterator>
#include <iostream>
#include <vector>
#include <forward_list>
int main() {
 std::vector<int> vector { 1, 2, 3 }; // random access iterator

 auto it1 = std::next(vector.begin(), 2);
 auto it2 = std::prev(vector.end(), 2);
 std::cout << *it1; // 3
 std::cout << *it2; // 2
 std::cout << std::distance(it2, it1); // 1

 std::advance(it2, 1);
 std::cout << *it2; // 3

 //-----
 std::forward_list<int> list { 1, 2, 3 }; // forward iterator
 // std::prev(list.end(), 1); // compile error
}
```

# Container Access Methods

C++11 provides a generic interface for containers, plain arrays, and std::initializer\_list to access to the corresponding iterator.

Standard method `.begin()` , `.end()` etc., are not supported by plain array and initializer list

- `std::begin` begin iterator
- `std::cbegin` begin const iterator
- `std::rbegin` begin reverse iterator
- `std::crbegin` begin const reverse iterator
- `std::end` end iterator
- `std::cend` end const iterator
- `std::rend` end reverse iterator
- `std::crend` end const reverse iterator

```
#include <iterator>
#include <iostream>

int main() {
 int array[] = { 1, 2, 3 };

 for (auto it = std::crbegin(array); it != std::crend(array); it++)
 std::cout << *it << ", "; // 3, 2, 1
}
```

`std::iterator_traits` allows retrieving iterator properties

- `difference_type` a type that can be used to identify distance between iterators
- `value_type` the type of the values that can be obtained by dereferencing the iterator. This type is void for output iterators
- `pointer` defines a pointer to the type iterated over `value_type`
- `reference` defines a reference to the type iterated over `value_type`
- `iterator_category` the category of the iterator. Must be one of iterator category tags

```
#include <iterator>

template<typename T>
void f(const T& list) {
 using D = std::iterator_traits<T>::difference_type; // D is std::ptrdiff_t
 // (pointer difference)
 // (signed size_t)

 using V = std::iterator_traits<T>::value_type; // V is double
 using P = std::iterator_traits<T>::pointer; // P is double*
 using R = std::iterator_traits<T>::reference; // R is double&

 // C is BidirectionalIterator
 using C = std::iterator_traits<T>::iterator_category;
}

int main() {
 std::list<double> list;
 f(list);
}
```

# Algorithms Library

---

## C++ STL Algorithms library

The algorithm library provides functions for a variety of purposes (e.g. searching, sorting, counting, manipulating) that operate on ranges of elements

- STL Algorithm library allow great flexibility which makes included functions suitable for solving real-world problem
- The user can adapt and customize the STL through the use of function objects
- Library functions work independently on containers and plain array
- Many of them support `constexpr` in C++20

```
#include <algorithm>
#include <vector>
struct Unary {
 bool operator()(int value) {
 return value <= 6 && value >= 3;
 }
};
struct Descending {
 bool operator()(int a, int b) {
 return a > b;
 }
};

int main() {
 std::vector<int> vector { 7, 2, 9, 4 };
 // returns an iterator pointing to the first element in the range[3, 6]
 std::find_if(vector.begin(), vector.end(), Unary());
 // sort in descending order : { 9, 7, 4, 2 };
 std::sort(vector.begin(), vector.end(), Descending());
}
```

```
#include <algorithm> // it includes also std::multiplies
#include <vector>
#include <cstdlib> // std::rand
#include <numeric> // std::accumulate
struct Unary {
 bool operator()(int value) { return value > 100; }
};
int main() {
 std::vector<int> vector { 7, 2, 9, 4 };
 int product = std::accumulate(vector.begin(), vector.end(), // product = 504
 1, std::multiplies<int>());
 std::generate(vector.begin(), vector.end(), std::rand);
 // now vector has 4 random values

 // remove all values > 100 using Erase-remove idiom
 auto new_end = std::remove_if(vector.begin(), vector.end(), Unary());
 // elements are removed, but vector size is still unchanged
 vector.erase(new_end, vector.end()); // shrink vector to finish removal
}
```



# STL Algorithms Library (Possible Implementations)

## std::find

```
template<class InputIt, class T>
InputIt find(InputIt first, InputIt last, const T& value) {
 for (; first != last; ++first) {
 if (*first == value)
 return first;
 }
 return last;
}
```

## std::generate

```
template<class ForwardIt, class Generator>
void generate(ForwardIt first, ForwardIt last, Generator g) {
 while (first != last)
 *first++ = g();
}
```

- `swap(v1, v2)` Swaps the values of two objects
- `min(x, y)` Finds the minimum value between x and y
- `max(x, y)` Finds the maximum value between x and y
- `min_element(begin, end)` (returns a pointer)  
Finds the minimum element in the range [begin, end)
- `max_element(begin, end)` (returns a pointer)  
Finds the maximum element in the range [begin, end)
- `minmax_element(begin, end)` C++11 (returns pointers <min,max>)  
Finds the minimum and the maximum element in the range [begin, end)

- `equal(begin1, end1, begin2)`  
Determines if two sets of elements are the same in  $[begin1, end1)$ ,  $[begin2, begin2 + end1 - begin1)$
- `mismatch(begin1, end1, begin2)` (returns pointers  $\langle pos1, pos2 \rangle$ )  
Finds the first position where two ranges differ in  $[begin1, end1)$ ,  $[begin2, begin2 + end1 - begin1)$
- `find(begin, end, value)` (returns a pointer)  
Finds the first element in the range  $[begin, end)$  equal to value
- `count(begin, end, value)`  
Counts the number of elements in the range  $[begin, end)$  equal to value

- `sort(begin, end)` (in-place)  
Sorts the elements in the range `[begin, end)` in ascending order
- `merge(begin1, end1, begin2, end2, output)`  
Merges two sorted ranges `[begin1, end1)`, `[begin2, end2)`, and store the results in `[output, output + end1 - start1)`
- `unique(begin, end)` (in-place)  
Removes consecutive duplicate elements in the range `[begin, end)`
- `binary_search(begin, end, value)`  
Determines if an element value exists in the (sorted) range `[begin, end)`
- `accumulate(begin, end, value)`  
Sums up the range `[begin, end)` of elements with initial value (common case equal to zero)
- `partial_sum(begin, end)` (in-place)  
Computes the inclusive prefix-sum of the range `[begin, end)`

- `fill(begin, end, value)`  
Fills a range of elements `[begin, end)` with `value`
- `iota(begin, end, value)` C++11  
Fills the range `[begin, end)` with successive increments of the starting value
- `copy(begin1, end1, begin2)`  
Copies the range of elements `[begin1, end1)` to the new location `[begin2, begin2 + end1 - begin1)`
- `swap_ranges(begin1, end1, begin2)`  
Swaps two ranges of elements `[begin1, end1)`, `[begin2, begin2 + end1 - begin1)`
- `remove(begin, end, value)` (in-place)  
Removes elements equal to `value` in the range `[begin, end)`
- `includes(begin1, end1, begin2, end2)`  
Checks if the (sorted) set `[begin1, end1)` is a subset of `[begin2, end2)`

- `set_difference(begin1, end1, begin2, end2, output)`  
Computes the difference between two (sorted) sets
- `set_intersection(begin1, end1, begin2, end2, output)`  
Computes the intersection of two (sorted) sets
- `set_symmetric_difference(begin1, end1, begin2, end2, output)`  
Computes the symmetric difference between two (sorted) sets
- `set_union(begin1, end1, begin2, end2, output)`  
Computes the union of two (sorted) sets
- `make_heap(begin, end)` Creates a max heap out of the range of elements
- `push_heap(begin, end)` Adds an element to a max heap
- `pop_heap(begin, end)` Remove an element (top) to a max heap

## Algorithm Library - Other Examples

```
#include <algorithm>

int a = std::max(2, 5); // a = 5
int array1[] = {7, 6, -1, 6, 3};
int array2[] = {8, 2, 0, 3, 7};

int b = *std::max_element(array1, array1 + 5); // b = 7
auto c = std::minmax_element(array1, array1 + 5);
// *c.first = -1, *c.second = 7
bool d = std::equal(array1, array1 + 5, array2); // d = false

std::sort(array1, array1 + 5); // [-1, 3, 6, 6, 7]
std::unique(array1, array1 + 5); // [-1, 3, 6, 7]
int e = std::accumulate(array1, array1 + 4, 0); // 15
std::partial_sum(array1, array1 + 4, array1); // [-1, 2, 8, 15]
std::iota(array1, array1 + 5, 2); // [2, 3, 4, 5, 6]
std::make_heap(array2, array2 + 5); // [8, 7, 0, 3, 2]
```

# C++20 Ranges

---



# C++20 Ranges

*Ranges* are an abstraction that allows to operate on elements of data structures uniformly. They are an extension of the standard *iterators*

A **range** is an object that provides `begin()` and `end()` methods (an *iterator* + a *sentinel*)

`begin()` returns an *iterator*, which can be incremented until it reaches `end()`

```
template<typename T>
concept range = requires(T& t) {
 ranges::begin(t);
 ranges::end(t);
};
```

- 
- [An Overview of Standard Ranges](#)
  - [Range, Algorithms, Views, and Actions - A Comprehensive Guide](#)
  - [Eric Niebler - Range v3](#)
  - [Range by Example](#)

## Key Concepts

**Range View** is a *range* defined on top of another *range*

**Range Adaptors** are utilities to transform a *range* into a *view*

**Range Factory** is a *view* that contains no elements

**Range Algorithms** are library-provided functions that directly operate on ranges  
(corresponding to std iterator algorithm)

**Range Action** is an object that modifies the underlying data of a range

A **range view** is a *range* defined on top of another *range* that transforms the underlying way to access internal data

- *Views* do not own any data
- *copy, move, assignment* operations perform in constant time
- *Views* are *composable*
- *Views* are *lazy evaluated*

Syntax:

```
range/view | view
```

```
#include <iostream>
#include <ranges>
#include <vector>

std::vector<int> v{1, 2, 3, 4};

for (int x : v | std::views::reverse)
 std::cout << x << " "; // print: "4, 3, 2, 1"

auto rv2 = v | std::views::reverse; // cheap, it does not copy "v"

auto rv3 = v | std::views::drop(2) | // drop the first two elements
 std::views::reverse;
for (int x : rv3) // lazy evaluated
 std::cout << x << " "; // print: "4, 3"
```

**Range Adaptors** are utilities to transform a *range* into a *view* with custom behaviors

- *Range adaptors* produce lazily evaluated *views*
- *Range adaptors* can be chained or composed (pipeline)

Syntax:

```
adaptor(range/view, args...)
adaptor(args...)(range/view)
range/view | adaptor(args...) // preferred syntax
```

```
#include <iostream>
#include <ranges>
#include <vector>

std::vector<int> v{1, 2, 3, 4};

for (int x : v | std::ranges::reverse_view(v)) // @\textbf{adaptor}@
 std::cout << x << " "; // print: "4, 3, 2, 1"

auto rv2 = std::ranges::reverse_view(v); // cheap, it does not copy "v"

auto rv3 = std::ranges::reverse_view(
 std::ranges::drop_view(2, v)); // drop the first two elements
for (int x : rv3) // lazy evaluated
 std::cout << x << " "; // print: "4, 3"
```

# Range Factory

**Range Factory** produces a *view* that contains no elements

```
#include <iostream>
#include <ranges>

for (int x : std::ranges::iota_view{1, 4}) // factory (adaptor)
 std::cout << x << " "; // print: "1, 2, 3, 4"

for (int x : std::view::repeat('a', 4)) // factory (view)
 std::cout << x << " "; // print: "a, a, a, a"
```

# Range Algorithms

The **range algorithms** are almost identical to the corresponding *iterator-pair* algorithms in the `std` namespace, except that they have *concept*-enforced constraints and accept *range* arguments

- *Range algorithms* are immediately evaluated
- *Range algorithms* can work directly on containers (`begin()`, `end()` are no more explicitly needed) and *view*

```
#include <algorithm>
#include <vector>

std::vector<int> vec{3, 2, 1};
std::ranges::sort(vec); // 1, 2, 3
```



# Algorithm Operators and Projections

```
#include <algorithm>
#include <vector>

struct Data {
 char value1;
 int value2;
};

std::vector<int> vec{4, 2, 5};
auto cmp = [](auto a, auto b) { return a > b; }; // Unary boolean predicate
std::ranges::sort(vec, cmp); // 5, 4, 2

std::vector<Data> vec2{{'a', 4}, {'b', 2}, {'c', 5}};
std::ranges::sort(vec2, {}, &Data::value2); // Projection: 2, 4, 5
 // {'b', 2}, {'a', 4}, {'c', 5}
```

# Algorithms and Views

```
// sum of the squares of the first 'count' numbers
auto sum_of_squares(int count) {
 auto squares = std::views::iota(1, count) |
 std::views::transform([](int x) { return x * x; });
 return std::accumulate(squares, 0);
}
```

The **range actions** mimic *std algorithms* and *range algorithms* adding the **composability** property

- *Range actions* are *eager* evaluated
- *Range algorithms* work directly on *ranges*
- Not included in the `std` library

```
#include <algorithm>
#include <vector>

std::vector<int> vec{3, 5, 6, 3, 5}
// in-place
vec = vec | actions::sort // 3, 3, 5, 5, 6
 | actions::unique; // 3, 5, 6

vec |= actions::sort // 3, 3, 5, 5, 6
 | actions::unique; // 3, 5, 6
// out-of-place
auto vec2 = std::move(vec) | actions::sort // 3, 3, 5, 5, 6
 | actions::unique; // 3, 5, 6
```

# Modern C++ Programming

## 19. ADVANCED TOPICS I

---

*Federico Busato*

2024-11-05

## 1 Move Semantic

- lvalues and rvalues references
- Move Semantic
- `std::move`
- Class Declaration Semantic

## 2 Universal Reference and Perfect Forwarding

- Universal Reference
- Reference Collapsing Rules
- Perfect Forwarding

## 3 Value Categories

## 4 `&`, `&&` Ref-qualifiers and `volatile` Overloading

- `&`, `&&` Ref-qualifiers Overloading
- `volatile` Overloading

## 5 Copy Elision and RVO/NVRO

## 6 Type Deduction

- Pass-by-Reference
- Pass-by-Pointer
- Pass-by-Value
- auto Deduction
- auto(x): Decay-copy

## 7 const Correctness



# Move Semantic

---

***Move semantics refers in transferring ownership of resources from one object to another***

Differently from *copy semantic*, *move semantic* does not duplicate the original resource

In C++ every expression is either an **rvalue** or an **lvalue**

- a **lvalue** (left) represents an expression that occupies some identifiable location in memory
- a **rvalue** (right) is an expression that does not represent an object occupying some identifiable location in memory

```
int x = 5; // "x" is an lvalue, "5" is an rvalue
int y = 10; // "y" is an lvalue

int z = (x * y); // "z" is an lvalue, (x * y) is an rvalue
```

C++11 introduces a new kind of *reference* called **rvalue reference** `X&&`

- An **rvalue reference** only binds to an **rvalue**, that is a temporary
- An **lvalue reference** only binds to an **lvalue**
- A **const lvalue reference** binds to both **lvalue** and **rvalue**

```
int x = 5; // "x" is an lvalue
int& r1 = x; // "r1" is an lvalue reference
// int& r2 = 5; // compile error, "5" is an rvalue
const int& cr = (x * y); // "cr" is an const lvalue reference

int&& rv = (x * y); // "rv" is an rvalue reference, "(x * y)" is an rvalue
// int&& rv1 = x; // compile error, "x" is NOT an rvalue
```

```
struct A {};

void f(A& a) {} // lvalue reference

void g(const A& a) {} // const lvalue reference

void h(A&& a) {} // rvalue reference

A a;
f(a); // ok, f() can modify "a"
g(a); // ok, f() cannot modify "a"
// h(a); // compile error f() does not accept lvalues

// f(A{}); // compile error f() does not accept rvalues
g(A{}); // ok, f() cannot modify the object A{}
h(A{}); // ok, f() can modify the object A{}
```

```
#include <algorithm>
class Array { // Array Wrapper
public:
 Array() = default;

 Array(int size) : _size{size}, _array{new int[size]} {}

 Array(const Array& obj) : _size{obj._size}, _array{new int[obj._size]} {
 // EXPENSIVE COPY (deep copy)
 std::copy(obj._array, obj._array + _size, _array);
 }

 ~Array() { delete[] _array; }
private:
 int _size;
 int* _array;
};
```

```
#include <vector>

int main() {
 std::vector<Array> vector;
 vector.push_back(Array{1000}); // call push_back(const Array&)
} // expensive copy
```

**Before C++11:** `Array{1000}` is created, passed by const-reference, copied, and then destroyed

Note: `Array{1000}` is no more used outside `push_back`

**After C++11:** `Array{1000}` is created, and moved to `vector` (fast!)

**Class prototype** with support for *move semantic*:

```
class X {
public:
 X(); // default constructor

 X(const X& obj); // copy constructor

 X(X&& obj); // move constructor

 X& operator=(const X& obj); // copy assign operator

 X& operator=(X&& obj); // move assign operator

 ~X(); // destructor
};
```



## Move constructor semantic

```
X(X&& obj);
```

- (1) *Shallow copy* of `obj` data members (in contrast to deep copy)
- (2) *Release* any `obj` resources and reset all data members (pointer to `nullptr`, size to 0, etc.)

## Move assignment semantic

```
X& operator=(X&& obj);
```

- (1) *Release* any resources of `this`
- (2) *Shallow copy* of `obj` data members (in contrast to deep copy)
- (3) *Release* any `obj` resources and reset all data members (pointer to `nullptr`, size to 0, etc.)
- (4) Return `*this`

## Move constructor

```
Array(Array&& obj) {
 _size = obj._size; // (1) shallow copy
 _array = obj._array; // (1) shallow copy
 obj._size = 0; // (2) release obj (no more valid)
 obj._array = nullptr; // (2) release obj
}
```

## Move assignment

```
Array& operator=(Array&& obj) {
 delete[] _array; // (1) release this
 _size = obj._size; // (2) shallow copy
 _array = obj._array; // (2) shallow copy
 obj._array = nullptr; // (3) release obj
 obj._size = 0; // (3) release obj
 return *this; // (4) return *this
}
```

**C++11** provides the method `std::move` ( `<utility>` ) to indicate that an object may be “moved from”

It allows to efficient transfer resources from an object to another one

```
#include <vector>

int main() {
 std::vector<Array> vector;
 vector.push_back(Array{1000}); // call "push_back(Array&&)"

 Array arr{1000};
 vector.push_back(arr); // call "push_back(const Array&)"

 vector.push_back(std::move(arr)); // call "push_back(Array&&)"
 // efficient!!

 // "arr" is not more valid here
}
```

## Move Semantic Notes

If an object requires the *copy constructor/assignment*, then it should also define the *move constructor/assignment*. The opposite could not be true

The *defaulted move constructor/assignment* `=default` recursively applies the move semantic to its *base class* and *data members*.

Important: *it does not release the resources*. It is very dangerous for classes with manual resource management

```
// Suppose: Array(Array&&) = default;
Array x{10};
Array y = std::move(x); // call the move constructor
// "x" calls ~Array() when it is out of scope, but now the internal pointer
// "_array" is NOT nullptr -> double free or corruption!!
```

# Move Semantic and Code Reuse

Some operations can be expressed as a function of the move semantic

```
A& operator=(const A& other) {
 *this = std::move(A{other}); // copy constructor + move assignment
 return *this;
}
```

```
void init(... /* any paramters */) {
 *this = std::move(A{...}); // user-declared constructor + move assignment
}
```

## Special Members

compiler implicitly declares

|                     | default constructor | destructor    | copy constructor | copy assignment | move constructor | move assignment |
|---------------------|---------------------|---------------|------------------|-----------------|------------------|-----------------|
| Nothing             | defaulted           | defaulted     | defaulted        | defaulted       | defaulted        | defaulted       |
| Any constructor     | not declared        | defaulted     | defaulted        | defaulted       | defaulted        | defaulted       |
| default constructor | user declared       | defaulted     | defaulted        | defaulted       | defaulted        | defaulted       |
| destructor          | defaulted           | user declared | defaulted        | defaulted       | not declared     | not declared    |
| copy constructor    | not declared        | defaulted     | user declared    | defaulted       | not declared     | not declared    |
| copy assignment     | defaulted           | defaulted     | defaulted        | user declared   | not declared     | not declared    |
| move constructor    | not declared        | defaulted     | deleted          | deleted         | user declared    | not declared    |
| move assignment     | defaulted           | defaulted     | deleted          | deleted         | not declared     | user declared   |

Everything You Ever Wanted To Know About Move Semantics

A Quick Note of Copy and Move Control in C++

# Class Declaration Semantic

| User-declared Entity                  | Meaning / Implications                                                                                                                                                |
|---------------------------------------|-----------------------------------------------------------------------------------------------------------------------------------------------------------------------|
| <code>non-static const</code> members | <i>Copy/Move constructors</i> are not trivial (not provided by the compiler). <i>Copy/move assignment</i> is not supported                                            |
| reference members                     | <i>Copy/Move constructors/assignment</i> are not trivial (not provided by the compiler)                                                                               |
| destructor                            | The resource management is not trivial. <i>Copy constructor/assignment</i> is very likely to be implemented                                                           |
| copy constructor/assignment           | Resource management is not trivial. <i>Move constructors/assignment</i> need to be implemented by the user                                                            |
| move constructor/assignment           | There is an efficient way to move the object. <i>Copy constructor/assignment</i> cannot fall back safely to <i>copy constructors/assignment</i> , so they are deleted |

# Universal Reference and Perfect Forwarding

---



The `&&` syntax has two different meanings depending on the context it is used

- **rvalue reference**
- **Universal reference**: Either **rvalue reference** or **lvalue reference**

**Universal references** (also called *forwarding references*) are **rvalues** that appear in a type-deducing context. `T&&`, `auto&&` accept any expression regardless it is an **lvalue** or **rvalue** and preserve the `const` property

```
void f1(int&& t) {} // rvalue reference

template<typename T>
void f2(T&& t) {} // universal reference

int&& v1 = ...; // rvalue reference
auto&& v2 = ...; // universal reference
```

```
int f_copy() { return x; }
int& f_ref(int& x) { return x; }
const int& f_const_ref(const int& x) { return x; }

auto v1 = ...; // f_copy(), f_const_ref(), only lvalues
auto& v2 = ...; // f_ref(), only lvalue ref
const auto& v3 = ...; // f_copy(), f_ref(), f_const_ref()
 // only const lvalue ref (decay), cannot be modified
const auto&& v4 = ...; // f_copy(), only rvalues, cannot be modified

auto&& v5 = ...; // everything
```

```
struct A {};
void f1(A&& a) {} // rvalue only

template<typename T>
void f2(T&& t) {} // universal reference

A a;
f1(A{}); // ok
// f1(a); // compile error (only rvalue)
f2(A{}); // universal reference
f2(a); // universal reference

A&& a2 = A{}; // ok
// A&& a3 = a; // compile error (only rvalue)
auto&& a4 = A{}; // universal reference
auto&& a5 = a; // universal reference
```

## Universal Reference - Misleading Cases

```
template<typename T>
void f(std::vector<T>&&) {} // rvalue reference

template<typename T>
void f(const T&&) {} // rvalue reference (const)

const auto&& v = ...; // const rvalue reference
```

# Reference Collapsing Rules

Before C++11 (C++98, C++03), it was not allowed to take a reference to a reference ( `A& &` causes a compile error)

C++11, by contrast, introduces the following **reference collapsing rules**:

```
template<typename T>
void f(T&) {} // compile error in C++98/03 (with gcc),
 // no errors in C++11 (and clang with C++98/03)
int a = 3; //
f<int&>(a); //
```

| Type | Reference |   | Result |
|------|-----------|---|--------|
| A&   | &         | → | A&     |
| A&   | &&        | → | A&     |
| A&&  | &         | → | A&     |
| A&&  | &&        | → | A&&    |

# Perfect Forwarding

*Perfect forwarding* allows preserving argument *value category* and *const/volatile* modifiers

`std::forward` ( `<utility>` ) forwards the argument to another function with the *value category* it had when passed to the calling function (*perfect forwarding*)

```
#include <utility> // std::forward
template<typename T> void f(T& t) { cout << "lvalue"; }
template<typename T> void f(T&& t) { cout << "rvalue"; } // overloading

template<typename T> void g1(T&& obj) { f(obj); } // call only f(T&)
template<typename T> void g2(T&& obj) { f(std::forward<T>(obj)); }

struct A{};
f (A{10}); // print "rvalue"
g1(A{10}); // print "lvalue"!!
g2(A{10}); // print "rvalue"
```

# Value Categories

---

## Taxonomy (simplified)

Every expression is either an **rvalue** or an **lvalue**

- An **lvalue** (*left* value of an assignment for historical reason or *locator* value) represents an expression that occupies an *identity*, namely a memory location (it has an address)
- An **rvalue** is movable; an **lvalue** is not



**glvalue** (*generalized lvalue*) is an expression that has an identity

**lvalue** is a **glvalue** but it is not movable (it is not an **xvalue**). An *named rvalue reference* is a **lvalue**

**xvalue** (*eXpiring*) has an identity and it is movable. It is a **glvalue** that denotes an object whose resources can be reused. An *unnamed rvalue reference* is a **xvalue**

**prvalue** (*pure rvalue*) doesn't have identity, but is movable. It is an expression whose evaluation initializes an object or computes the value of an operand of an operator

**rvalue** is movable. It is a **prvalue** or an **xvalue**

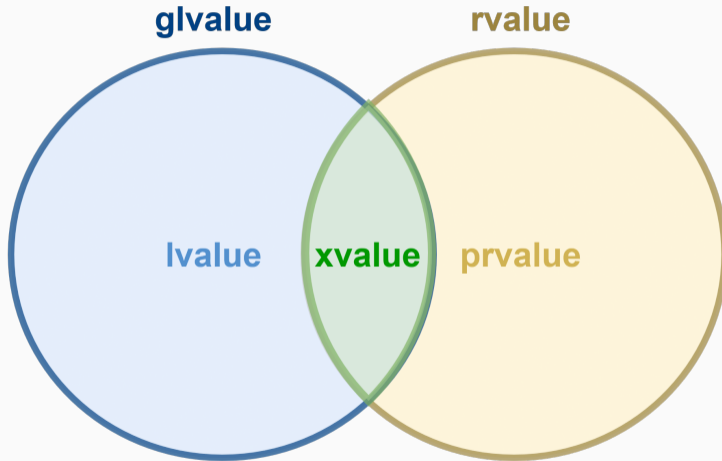

# Examples

```
struct A {
 int x;
};

void f(A&&) {}
A&& g();
//-----
int a = 4; // "a" is an lvalue, "4" is a prvalue
f(A{4}); // "A{4}" is a prvalue

A&& b = A{3}; // "A&& b" is a named rvalue reference → lvalue

A c{4};
f(std::move(c)); // "std::move(c)" is a xvalue
f(A{}.x); // "A{}.x" is a xvalue
g(); // "A&&" is a xvalue
```

# **&, && Ref-qualifiers and volatile Overloading**

---

C++11 allows overloading member functions depending on the **lvalue/rvalue** property of their object. This is also known as **ref-qualifiers overloading** and can be useful for optimization purposes, namely, moving a variable instead of copying it

```
struct A {
 // void f() {} // already covered by "f() &"
 void f() & {}
 void f() && {}
};

A a1;
a1.f(); // call "f() &"

A{}.f(); // call "f() &&"
std::move(a1).f(); // call "f() &&"
```

*Ref-qualifiers overloading* can be also combined with `const` methods

```
struct A {
 // void f() const {} // already covered by "f() const &"
 void f() const & {}
 void f() const && {}
};

const A a1;
a1.f(); // call "f() const &"

std::move(a1).f(); // call "f() const &&"
```

A simple example where *ref-qualifiers overloading* is useful

```
struct ArrayWrapper {
 ArrayWrapper(/*params*/) { /* something expensive */ }

 ArrayWrapper copy() const & { /* expensive copy with std::copy() */ }
 ArrayWrapper copy() const && { /* just move the pointer as the original
 object is no more used */ }
};
```

## volatile Overloading

```
struct A {
 void f() {}
 void f() volatile {} // e.g. propagate volatile to data members
 void f() const volatile {}
// void f() volatile & {} // combining ref-qualifier and volatile
// void f() const volatile & {} // overloading is also fine
// void f() volatile && {}
// void f() const volatile && {}
};

volatile A a1;
a1.f(); // call "f() volatile"

const volatile A a2;
a2.f(); // call "f() const volatile"
```



# Copy Elision and RVO/NVRO

---

## Copy Elision and RVO/NVRO

**Copy elision** is a compiler optimization technique that eliminates unnecessary copying/moving of objects (it is defined in the C++ standard)

A compiler avoids omitting copy/move operations with the following optimizations:

- **RVO (Return Value Optimization)** means the compiler is allowed to avoid creating *temporary* objects for return values
- **NRVO (Named Return Value Optimization)** means the compiler is allowed to return an object (with automatic storage duration) without invokes copy/move constructors

## RVO Example

Returning an object from a function is *very expensive* without RVO/NVRO:

```
struct Obj {
 Obj() = default;

 Obj(const Obj&) { // non-trivial
 cout << "copy constructor\n";
 }
};

Obj f() { return Obj{}; } // first copy

auto x1 = f(); // second copy (create "x")
```

If provided, the compiler uses the *move constructor* instead of *copy constructor*

## RVO - Where it works

*RVO Copy elision* is always guaranteed if the operand is a `prvalue` of the same class type and the *copy constructor* is trivial and non-deleted

```
struct Trivial {
 Trivial() = default;
 Trivial(const Trivial&) = default;
};

// single instance
Trivial f1() {
 return Trivial{}; // Guarantee RVO
}

// distinct instances and run-time selection
Trivial f2(bool b) {
 return b ? Trivial{} : Trivial{}; // Guarantee RVO
}
```

## Guaranteed Copy Elision (C++17)

In C++17, *RVO Copy elision* is always guaranteed if the operand is a `prvalue` of the same class type, even if the *copy constructor* is not trivial or deleted

```
struct S1 {
 S1() = default;
 S1(const S1&) = delete; // deleted
};

struct S2 {
 S2() = default;
 S2(const S2&) {} // non-trivial
};

S1 f() { return S1{}; }
S2 g() { return S2{}; }

auto x1 = f(); // compile error in C++14
auto x2 = g(); // RVO only in C++17
```

NRVO is not always guarantee even in C++17

```
Obj f1() {
 Obj a;
 return a; // most compilers apply NRVO
}

Obj f2(bool v) {
 Obj a;
 if (v)
 return a; // copy/move constructor
 return Obj{}; // RVO
}
```

GCC 14 adds the flag `-Wnvro` to diagnose when NRVO is not possible

```
Obj f3(bool v) {
 Obj a, b;
 return v ? a : b; // copy/move constructor
}

Obj f4() {
 Obj a;
 return std::move(a); // force move constructor
}

Obj f5() {
 static Obj a;
 return a; // only copy constructor is possible
}
```

```
Obj f6(Obj& a) {
 return a; // copy constructor (a reference cannot be elided)
}

Obj f7(const Obj& a) {
 return a; // copy constructor (a reference cannot be elided)
}

Obj f8(const Obj a) {
 return a; // copy constructor (a const object cannot be elided)
}

Obj f9(Obj&& a) {
 return a; // copy constructor (the object is instantiated in the function)
}
```



# Type Deduction

---

**When you call a template function, you may omit any template argument that the compiler can determine or deduce (inferred) by the usage and context of that template function call [IBM]**

- The compiler tries to deduce a template argument by comparing the type of the corresponding template parameter with the type of the argument used in the function call
- Similar to function default parameters, (any) template parameters can be deduced only if they are at end of the parameter list

Full Story: [IBM Knowledge Center](#)

## Example

```
template<typename T>
int add1(T a, T b) { return a + b; }

template<typename T, typename R>
int add2(T a, R b) { return a + b; }

template<typename T, int B>
int add3(T a) { return a + B; }

template<int B, typename T>
int add4(T a) { return a + B; }

add1(1, 2); // ok
// add1(1, 2u); // the compiler expects the same type
add2(1, 2u); // ok (add2 is more generic)
add3<int, 2>(1); // "int" cannot be deduced
add4<2>(1); // ok
```

# Type Deduction - Pass by-Reference

## Type deduction with references

```
template<typename T>
void f(T& a) {}

template<typename T>
void g(const T& a) {}

int x = 3;
int& y = x;
const int& z = x;
f(x); // T: int
f(y); // T: int
f(z); // T: const int // <-- !! it works...but it does not
g(x); // T: int // for "f(int& a)"!!
g(y); // T: int // (only non-const references)
g(z); // T: int // <-- note the difference
```

## Type deduction with pointers

```
template<typename T>
void f(T* a) {}

template<typename T>
void g(const T* a) {}

int* x = nullptr;
const int* y = nullptr;
auto z = nullptr;
f(x); // T: int
f(y); // T: const int
// f(z); // compile error!! z: "nullptr_t != T*"
g(x); // T: int
g(y); // T: int <-- note the difference
```

```
template<typename T>
void f(const T* a) {} // pointer to const-values
```

```
template<typename T>
void g(T* const a) {} // const pointer
```

```
int* x = nullptr;
```

```
const int* y = nullptr;
```

```
int* const z = nullptr;
```

```
const int* const w = nullptr;
```

```
f(x); // T: int
```

```
f(y); // T: int
```

```
f(z); // T: int
```

```
g(x); // T: int
```

```
g(y); // T: const int
```

```
g(z); // T: int
```

```
g(w); // T: const int
```

## Type deduction with values

```
template<typename T>
void f(T a) {}

template<typename T>
void g(const T a) {}

int x = 2;
const int y = 3;
const int& z = y;
f(x); // T: int
f(y); // T: int!! (drop const)
f(z); // T: int!! (drop const&)
g(x); // T: int
g(y); // T: int
g(z); // T: int!! (drop reference)
```

```
template<typename T>
void f(T a) {}

int* x = nullptr;
const int* y = nullptr;
int* const z = x;
f(x); // T = int*
f(y); // T = const int*
f(z); // T = int* !! (const drop)
```



# Type Deduction - Array

## Type deduction with arrays

```
template<typename T, int N>
void f(T (&array)[N]) {} // type and size deduced

template<typename T>
void g(T array) {}

int x[3] = {};
const int y[3] = {};
f(x); // T: int, N: 3
f(y); // T: const int, N: 3
g(x); // T: int*
g(y); // T: const int*
```

```
template<typename T>
void add(T a, T b) {}
```

```
template<typename T, typename R>
void add(T a, R b) {}
```

```
template<typename T>
void add(T a, char b) {}
```

```
add(2, 3.0f); // call add(T, R)
// add(2, 3); // error!! ambiguous match
add<int>(2, 3); // call add(T, T)
add<int, int>(2, 3); // call add(T, R)
add(2, 'b'); // call add(T, char) -> nearest match
```

```
template<typename T, int N>
void f(T& array) {}

template<typename T>
void f(T* array) {}

int x[3];
f(x); // call f(T*) not f(T&) !!
```

```
template<typename T, int N>
void g(T& array) {}

template<typename T>
void g(T array) {}

int x[3];
g(x); // call g(T) not g(T&) !!
```

# auto Deduction

- `auto x =` copy by-value/by-const value
- `auto& x =` copy by-reference/by-const-reference
- `auto* x =` copy by-pointer/by-const-pointer
- `auto&& x =` copy by-universal reference
- `decltype(auto) x =` automatic type deduction

```
int f1(int& x) { return x; }
int& f2(int& x) { return x; }
auto f3(int& x) { return x; }
decltype(auto) f4(int& x) { return x; }
```

```
int v = 3;
int x1 = f1(v);
int& x2 = f2(v);
// int& x3 = f3(v); // compile error 'x' is copied by-value
int& x4 = f4(v);
```

**The problem:** implement a function to remove the first element of a container

```
template<typename T>
void pop_v1(T& x) {
 std::remove(x.begin(), x.end(), x.front()); // undefined behavior!!
}
```

This is *undefined behavior* because

- `x.front()` returns a reference
- `std::remove` takes the element to remove by-const-reference
- `std::remove` modifies the container, invalidating iterators and references. The reference must not be an element of the range `[first, last)`

Sub-optimal solutions:

```
template<typename T>
void pop_v2(T& x) {
 auto tmp = x.front(); // lvalue copy
 std::remove(x.begin(), x.end(), tmp); // ok
}
```

```
template<typename T>
void pop_v3(T& x) {
 using R = std::decay_t<decltype(x.front())>; // verbose/non-trivial solution
 std::remove(x.begin(), x.end(), R(x)); // ok, create a temporary (rvalue)
} // copy

// decltype(x.front()) -> retrieve the type of x.front()
// std::decay_t -> get the 'decay' type as pass by-value,
// e.g. 'const int' to 'int'
```

C++23 introduces `auto(x)` *decay-copy* utility to express the rvalue copy in a clear way

```
template<typename T>
void pop_v4(T& x) {
 std::remove(x.begin(), x.end(), auto(x.front())); // ok, rvalue copy
} // equivalent to R(x)
```

# const **C**orrectness

---



**const correctness** refers to guarantee object/variable const consistency throughout its lifetime and ensuring safety from unintentional modifications

References:

- Isocpp: `const-correctness`
- GotW: `Const-Correctness`
- Abseil: `Meaningful 'const' in Function Declarations`
- `const` is a contract
- `Why const Doesn't Make C Code Faster`
- `Constant Optimization?`

- `const` entities do not change their values at run-time. This does not imply that they are evaluated at compile-time
- `const T*` is different from `T* const`. The first case means “*the content does not change*”, while the later “*the value of the pointer does not change*”
- Pass *by-const-value* and *by-value* parameters imply the *same* function signature
- Return *by-const-value* and *by-value* have different meaning
- `const_cast` can *break* const-correctness

**const** and member functions:

- `const` member functions do not change the internal status of an object
- `mutable` fields can be modified by a `const` member function (they should not change the external view)

**const** and code optimization:

- `const` keyword purpose is for correctness (*type safety*), not for performance
- `const` may provide performance advantages in a few cases, e.g. non-trivial copy semantic

## Function Declarations Example

```
void f(int);
void f(const int); // the declaration is exactly the same of
 // "void f(int)"!!

void f(int*);
void f(const int*); // different declaration

void f(int&);
void f(const int&); // different declaration
```

```
int f();
// const int f(); // compile error conflicting declaration
```

## const Return Example

```
const int const_value = 3;

const int& f2() { return const_value; }
// int& f1() { return const_value; } // WRONG
int f3() { return const_value; } // ok
```

```
struct A {
 void f() { cout << "non-const"; }
 void f() const { cout << "const"; }
};
```

```
const A getA() { return A{}; }
```

```
auto a = getA(); // "a" is a copy
a.f(); // print "non-const"
```

```
getA().f(); // print "const"
```

## struct Example

```
struct A { // struct A_const { // equal to "const A"
 int* ptr; // int* const ptr;
 int value; // const int value;
}; // };

void f(A a) {
 a.value = 3;
 a.ptr[0] = 3;
}

void g(const A a) { // the same with g(const A&)
// a.value = 3; // compile error
 a.ptr[0] = 3; // "const" does not apply to "ptr" content!!
}

A a{new int[10]};
f(a);
g(a);
```

## Member Functions Example

```
struct A {
 int value = 0;

 int& f1() { return value; }
 const int& f2() { return value; }

 // int& f3() const { return value; } // WRONG
 const int& f4() const { return value; }

 int f5() const { return value; } // ok
 const int f6() const { return value; }
};
```

# Modern C++ Programming

## 20. ADVANCED TOPICS II

---

*Federico Busato*

2024-11-05



## **1** Undefined Behavior

- Illegal Behavior
- Platform Specific Behavior
- Unspecified Behavior
- Detecting Undefined Behavior

## 2 Error Handling

- Recoverable Error Handling
- Return Code
- C++ Exceptions
- Defining Custom Exceptions
- `noexcept` Keyword
- Memory Allocation Issues
- Return Code and Exception Summary
- `std::expected`
- Alternative Error Handling Approaches

## 3 Smart pointers

- `std::unique_ptr`
- `std::shared_ptr`
- `std::weak_ptr`

## 4 Concurrency

- Thread Methods
- Mutex
- Atomic
- Task-based parallelism

# Undefined Behavior

---

# Undefined Behavior Overview

**Undefined behavior** means that the semantic of certain operations is

- *Unspecified behavior*: outside the language/library specification, two or more choices
- *Illegal*: the compiler presumes that such operations never happen, e.g. integer overflow
- *Implementation-defined behavior*: depends on the compiler and/or platform (not portable)

Motivations behind undefined behavior:

- *Compiler optimizations*, e.g. signed overflow or NULL pointer dereferencing
- *Simplify compile checks*
- *Unfeasible/expensive* to check

- 
- What Every C Programmer Should Know About Undefined Behavior, *Chris Lattner*
  - What are all the common undefined behaviors that a C++ programmer should know about?
  - Enumerating Core Undefined Behavior

- `const_cast` applied to a `const` variables

```
const int var = 3;
const_cast<int&>(var) = 4;
... // use var
```

- Memory alignment

```
char* ptr = new char[512];
auto ptr2 = reinterpret_cast<uint64_t*>(ptr + 1);
ptr2[3]; // ptr2 is not aligned to 8 bytes (sizeof(uint64_t))
```

- Memory initialization

```
int var; // undefined value
auto var2 = new int; // undefined value
```

- **Memory access-related:** *Out-of-bound access:* the code could crash or not depending on the platform/compiler

- **Strict aliasing**

```
float x = 3;
auto y = reinterpret_cast<unsigned&>(x);
// x, y break the strict aliasing rule
```

- **Lifetime issues**

```
int* f() {
 int tmp[10];
 return tmp;
}
int* ptr = f();
ptr[0];
```

- **One Definition Rule violation**

- Different definitions of `inline` functions in distinct translation units

- **Missing `return` statement**

```
int f(float x) {
 int y = x * 2;
}
```

- **Dangling reference**

```
iint n = 1;
const int& r = std::max(n-1, n+1); // dangling
// GCC 13 experimental -Wdangling-reference (enabled by -Wall)
```

- **Illegal arithmetic and conversion operations**

- Division by zero `0 / 0`, `fp_value / 0.0`
- Floating-point to integer conversion



# Platform Specific Behavior

- **Memory access-related:** `NULL` *pointer dereferencing*: the `0x0` address is valid in some platforms

- **Endianness**

```
union U {
 unsigned x;
 char y;
};
```

- **Type definition**

```
long x = 1ul << 32u; // different behavior depending on the OS
```

- **Intrinsic functions**

Legal operations but the C++ standard does not document the result → different compilers/platforms can show different behavior

- Signed shift of negative values `-2 << x` (before C++20), large-than-type shift `3u << 32`, etc.
- Floating-point narrowing conversion between floating-point types with unrepresentable values `double → float`
- Arithmetic operation ordering `f(i++, i++)`
- Function evaluation ordering

```
auto x = f() + g(); // C++ doesn't ensure that f() is evaluated before g()
```

- Signed overflow

```
for (int i = 0; i <= N; i++)
```

if `N` is `INT_MAX`, the last iteration is undefined behavior. The compiler can assume that the loop is finite and enable important optimizations, as opposite to `unsigned` (wrap around)

- Trivial infinite loops, until C++26

```
int main() {
 while (true) // -> std::this_thread::yield(); in C++26
 ;
}
void unreachable() { cout << "Hello world!" << endl; }
```

the code print Hello world! with some clang versions

# Detecting Undefined Behavior

There are several ways to detect or prevent undefined behavior at compile-time and at run-time:

- Modify the compiler behavior, see [Debugging and Testing: Hardening Techniques](#)
- Using undefined behavior sanitizer, see [Debugging and Testing: Sanitizer](#)
- Static analysis tools
- `constexpr` expressions doesn't allow undefined behavior

```
constexpr int x1 = 2147483647 + 1; // compile error
constexpr int x2 = (1 << 32); // compile error
constexpr int x3 = (1 << -1); // compile error
constexpr int x4 = 3 / 0; // compile error
constexpr int x5 = *((int*) nullptr) // compile error
constexpr int x6 = 6
constexpr float x7 = reinterpret_cast<float&>(x6); // compile error
```

# Error Handling

---

# Recoverable Error Handling

**Recoverable** *Conditions that are not under the control of the program.* They indicate “*exceptional*” run-time conditions. e.g. file not found, bad allocation, wrong user input, etc.

A *recoverable* should be considered *unrecoverable* if it is extremely rare and difficult to handle, e.g. bad allocation due to out-of-memory error

The common ways for handling recoverable errors are:

**Exceptions** Robust but slower and requires more resources

**Return code** Fast but difficult to handle in complex programs

## Error Handling References

- Modern C++ best practices for exceptions and error handling
- Back to Basics: Exceptions - CppCon2020
- ISO C++ FAQ: Exceptions and Error Handling
- Zero-overhead deterministic exceptions: Throwing values, P0709
- C++ exceptions are becoming more and more problematic, P2544
- `std::expected`
- C++ Error Handling Strategies { Benchmarks and Performance

## Return Code

Historically, C programs handled errors with return codes, even for unrecoverable errors

```
enum Status { IllegalValue, Success };

Status f(int* ptr) { return (ptr == nullptr) ? IllegalValue : Success; }
```

Why such behavior? Debugging → need to understand what / where / why the program failed

A better approach in C++ involves `std::source_location()` C++20 and `std::stacktrace()` C++23

ABI related issues:

- Removing an enumerator value is an API breaking change
- Adding a new enumerator value associated to a return type is also problematic as it causes ABI breaking change



## C++ Exceptions - Advantages

C++ Exceptions provide a well-defined mechanism to detect errors passing the information up the call stack

- **Exceptions cannot be ignored.** Unhandled exceptions stop program execution (call `std::terminate()`)
- **Intermediate functions are not forced to handle them.** They don't have to coordinate with other layers and, for this reason, they provide good composability
- Throwing an exception **acts like a return statement** destroying all objects in the current scope
- An exception enables a **clean separation** between the code that detects the error and the code that handles the error
- Exceptions work well with object-oriented semantic (constructor)

- **Code readability:** Using exception can involve more code than the functionality itself
- **Code comprehension:** Exception control flow is invisible and it is not explicit in the function signature
- **Performance:** Extreme performance overhead in the failure case (violate the zero-overhead principle)
- **Dynamic behavior:** `throw` requires dynamic allocation and `catch` requires RTTI. It is not suited for real-time, safety-critical, or embedded systems
- **Code bloat:** Exceptions could increase executable size by 5-15% (or more\*)

---

\*Binary size and exceptions

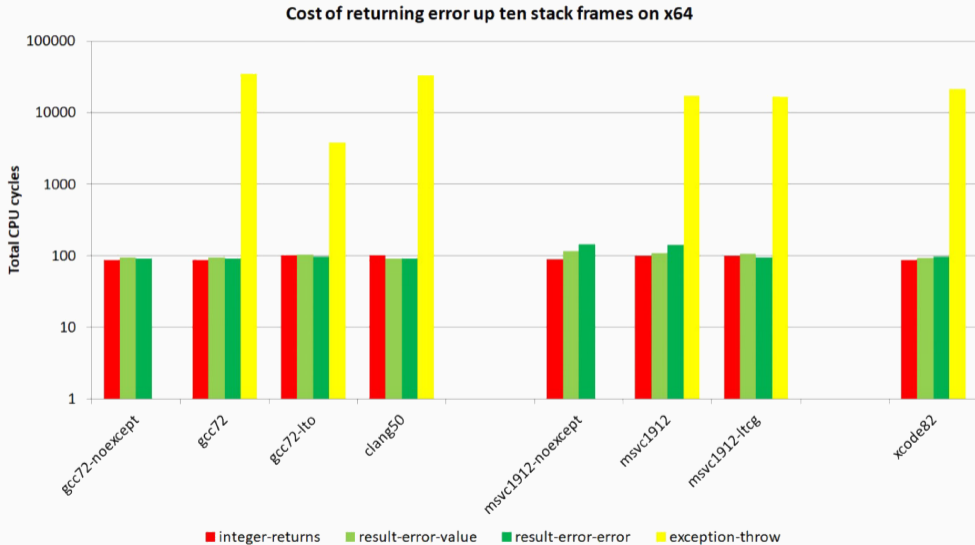

# C++ Exception Basics

C++ provides three keywords for exception handling:

`throw` Throws an exception

`try` Code block containing potential throwing expressions

`catch` Code block for handling the exception

```
void f() { throw 3; }

int main() {
 try {
 f();
 } catch (int x) {
 cout << x; // print "3"
 }
}
```

## std Exceptions

`throw` can throw everything such as integers, pointers, objects, etc. The standard way consists in using the std library exceptions `<stdexcept>`

```
#include <stdexcept>

void f(bool b) {
 if (b)
 throw std::runtime_error("runtime error");
 throw std::logic_error("logic error");
}

int main() {
 try {
 f(false);
 } catch (const std::runtime_error& e) {
 cout << e.what();
 } catch (const std::exception& e) {
 cout << e.what(); // print: "logic error"
 }
}
```

# Exception Capture

*NOTE:* C++, differently from other programming languages, does not require explicit dynamic allocation with the keyword `new` for throwing an exception. The compiler implicitly generates the appropriate code to construct and clean up the exception object. Dynamically allocated objects require a `delete` call

The right way to capture an exception is by `const`-reference. Capturing by-value is also possible but, it involves useless copy for non-trivial exception objects

`catch(...)` can be used to capture any thrown exception

```
int main() {
 try {
 throw "runtime error"; // throw const char*
 } catch (...) {
 cout << "exception"; // print "exception"
 }
}
```

# Exception Propagation

Exceptions are automatically propagated along the call stack. The user can also control how they are propagated

```
int main() {
 try {
 ...
 } catch (const std::runtime_error& e) {
 throw e; // propagate a copy of the exception
 } catch (const std::exception& e) {
 throw; // propagate the exception
 }
}
```

## Defining Custom Exceptions

```
#include <exception> // to not confuse with <stdexcept>

struct MyException : public std::exception {
 const char* what() const noexcept override { // could be also "constexpr"
 return "C++ Exception";
 }
};

int main() {
 try {
 throw MyException();
 } catch (const std::exception& e) {
 cout << e.what(); // print "C++ Exception"
 }
}
```



## noexcept Keyword

C++03 allows listing the exceptions that a function might directly or indirectly throw, e.g. `void f() throw(int, const char*) {`

C++11 deprecates `throw` and introduces the `noexcept` keyword

```
void f1(); // may throw
void f2() noexcept; // does not throw
void f3() noexcept(true); // does not throw
void f4() noexcept(false); // may throw
template<bool X>
void f5() noexcept(X); // may throw if X is false
```

If a `noexcept` function throw an exception, the runtime calls `std::terminate()`

`noexcept` should be used when throwing an exception is impossible or unacceptable.

It is also useful when the function contains code outside user control, e.g. `std` functions/objects

Exception handlers can be defined around the body of a function

```
void f() try {
 ... // do something
} catch (const std::runtime_error& e) {
 cout << e.what();
} catch (...) { // other exception
 ...
}
```

The `new` operator automatically throws an exception ( `std::bad_alloc` ) if it cannot allocate the memory

`delete` never throws an exception (unrecoverable error)

```
int main() {
 int* ptr = nullptr;
 try {
 ptr = new int[1000];
 }
 catch (const std::bad_alloc& e) {
 cout << "bad allocation: " << e.what();
 }
 delete[] ptr;
}
```

C++ also provides an overload of the `new` operator with non-throwing memory allocation

```
#include <new> // std::nothrow

int main() {
 int* ptr = new (std::nothrow) int[1000];
 if (ptr == nullptr)
 cout << "bad allocation";
}
```

Throwing exceptions in *constructors* is fine while it is not allowed in *destructors*

```
struct A {
 A() { new int[10]; }
 ~A() { throw -2; }
};

int main() {
 try {
 A a; // could throw "bad_alloc"
 // "a" is out-of-scope -> throw 2
 } catch (...) {
 // two exceptions at the same time
 }
}
```

*Destructors* should be marked `noexcept`

```
struct A {
 int* ptr1, *ptr2;

 A() {
 ptr1 = new int[10];
 ptr2 = new int[10]; // if bad_alloc here, ptr1 is lost
 }
};
```

```
struct A {
 std::unique_ptr<int> ptr1, ptr2;

 A() {
 ptr1 = std::make_unique<int[]>(10);
 ptr2 = std::make_unique<int[]>(10); // if bad_alloc here,
 // ptr1 is deallocated
 }
};
```

# Return Code and Exception Summary

## Exception

## Return Code

### Pros

- Cannot be ignored
- Work well with object-oriented semantic
- Information: Exceptions can be arbitrarily rich
- Clean code: Conceptually, clean separation between the code that detects errors and the code that handles the error, but...\*
- Non-Intrusive wrt. API: Proper communication channel

- Visibility: prototype of the called function
- No performance overhead
- No code bloat
- Easy to debug

### Cons

- Visibility: Not visible without further analysis of the code or documentation
- Clean code: \*... handling exception can generate more code than the functionality itself
- Dynamic behavior: memory and RTTI
- Extreme performance overhead in the failure case
- Code bloat
- Non-trivial to debug

- Easy to ignore, `[[deprecated]]` can help
- Cannot be used with object-oriented semantic
- Information: Historically, a simple integer. Nowadays, richer error code
- Clean code: At least, an if statement after each function call
- Non-Intrusive wrt. API: Monopolization of the return channel

C++23 introduces `std::expected` to get the best properties of return codes and exceptions

The class template `expected<T, E>` contains either:

- A value of type `T`, the expected value type; or
- A value of type `E`, an error type used when an unexpected outcome occurred

```
enum class Error { Invalid };

std::expected<int, Error> f(int v) {
 if (v > 0)
 return 3;
 return std::unexpected(Error::Invalid);
}
```



The user chooses how to handle the error depending on the context

```
auto ret = f(n);

// Return code handling
if (!ret)
 // error handling
 int v = *ret + 3; // execute without checking

// Exception handling
ret.value(); // throw an exception if there is a problem

// Monadic operations
auto lambda = [](int x) { return (x > 3) ? 4 : std::unexpected(Error::Invalid); };
ret.and_then(lambda) // pass the value to another function
 .transform([](int x) { return x + 4; }); // transform the previous value
 .transform_error([](auto error_code){ /*error handling*/ });
```

- **Global state**, e.g. `errno`
  - Easily forget to check for failures
  - Error propagation using `if` statements and early `return` is manual
  - No compiler optimizations due to global state
  
- **Simple error code**, e.g. `int`, `enum`, etc.
  - Easily forget to check for failures (workaround `[[nodiscard]]` )
  - Error propagation using `if` statements and early `return` is manual
  - Potential error propagation through different contexts and losing initial error information
  - Constructor errors cannot be handled

- `std::error_code`, standardized error code
  - Easily forget to check for failures (workaround `[[nodiscard]]`)
  - Error propagation using `if` statements and early `return` is manual
  - Code bloating for adding new enumerators (see Your own error code)
  - Constructor errors cannot be handled
- **Supporting libraries**, e.g. Boost Outcome, STX, etc.
  - Require external dependencies
  - Constructor errors cannot be handled in a direct way
  - Extra logic for managing return values

# Smart pointers

---

# Smart Pointers

**Smart pointer** is a pointer-like type with some additional functionality, e.g. *automatic memory deallocation* (when the pointer is no longer in use, the memory it points to is deallocated), reference counting, etc.

C++11 provides three smart pointer types:

- `std::unique_ptr`
- `std::shared_ptr`
- `std::weak_ptr`

Smart pointers prevent most situations of memory leaks by making the memory deallocation automatic

## Smart Pointers Benefits

- If a smart pointer goes *out-of-scope*, the appropriate method to release resources is called automatically. The memory is not left dangling
- Smart pointers will automatically be set to `nullptr` if not initialized or when memory has been released
- `std::shared_ptr` provides automatic reference count
- If a special `delete` function needs to be called, it will be specified in the pointer type and declaration, and will automatically be called on delete

`std::unique_ptr` is used to manage any dynamically allocated object that is not shared by multiple objects

```
#include <iostream>
#include <memory>
struct A {
 A() { std::cout << "Constructor\n"; } // called when A()
 ~A() { std::cout << "Destructor\n"; } // called when u_ptr1,
}; // u_ptr2 are out-of-scope
int main() {
 auto raw_ptr = new A();
 std::unique_ptr<A> u_ptr1(new A());
 std::unique_ptr<A> u_ptr2(raw_ptr);
 // std::unique_ptr<A> u_ptr3(raw_ptr); // no compile error, but wrong!! (not unique)

 // u_ptr1 = raw_ptr; // compile error (not unique)
 // u_ptr1 = u_ptr2; // compile error (not unique)
 u_ptr1 = std::move(u_ptr2); // delete u_ptr1;
} // u_ptr1 = u_ptr2;
 // u_ptr2 = nullptr
```

### std::unique\_ptr methods

- `get()` returns the underlying pointer
- `operator*` `operator->` dereferences pointer to the managed object
- `operator[]` provides indexed access to the stored array (if it supports random access iterator)
- `release()` returns a pointer to the managed object and releases the ownership
- `reset(ptr)` replaces the managed object with `ptr`

Utility method: `std::make_unique<T>()` creates a unique pointer to a class `T` that manages a new object



```
#include <iostream>
#include <memory>
struct A {
 int value;
};
int main() {
 std::unique_ptr<A> u_ptr1(new A());
 u_ptr1->value; // dereferencing
 (*u_ptr1).value; // dereferencing

 auto u_ptr2 = std::make_unique<A>(); // create a new unique pointer

 u_ptr1.reset(new A()); // reset
 auto raw_ptr = u_ptr1.release(); // release
 delete[] raw_ptr;

 std::unique_ptr<A[]> u_ptr3(new A[10]);
 auto& obj = u_ptr3[3]; // access
}
```

## Implement a custom deleter

```
#include <iostream>
#include <memory>
struct A {
 int value;
};
int main() {
 auto DeleteLambda = [](A* x) {
 std::cout << "delete" << std::endl;
 delete x;
 };

 std::unique_ptr<A, decltype(DeleteLambda)>
 x(new A(), DeleteLambda);
} // print "delete"
```

`std::shared_ptr` is the pointer type to be used for memory that can be owned by multiple resources at one time

`std::shared_ptr` maintains a reference count of pointer objects. Data managed by

`std::shared_ptr` is only freed when there are no remaining objects pointing to the data

```
#include <iostream>
#include <memory>
struct A {
 int value;
};
int main() {
 std::shared_ptr<A> sh_ptr1(new A());
 std::shared_ptr<A> sh_ptr2(sh_ptr1);
 std::shared_ptr<A> sh_ptr3(new A());
 sh_ptr3 = nullptr; // allowed, the underlying pointer is deallocated
 // sh_ptr3 : zero references
 sh_ptr2 = sh_ptr1; // allowed. sh_ptr1, sh_ptr2: two references
 sh_ptr2 = std::move(sh_ptr1); // allowed // sh_ptr1: zero references
 // sh_ptr2: one references
}
```

### std::shared\_ptr methods

- `get()` returns the underlying pointer
- `operator*` `operator->` dereferences pointer to the managed object
- `use_count()` returns the number of objects referring to the same managed object
- `reset(ptr)` replaces the managed object with `ptr`

Utility method: `std::make_shared()` creates a shared pointer that manages a new object

```
#include <iostream>
#include <memory>
struct A {
 int value;
};
int main() {
 std::shared_ptr<A> sh_ptr1(new A());
 auto sh_ptr2 = std::make_shared<A>(); // std::make_shared
 std::cout << sh_ptr1.use_count(); // print 1

 sh_ptr1 = sh_ptr2; // copy
 // std::shared_ptr<A> sh_ptr2(sh_ptr1); // copy (constructor)
 std::cout << sh_ptr1.use_count(); // print 2
 std::cout << sh_ptr2.use_count(); // print 2

 auto raw_ptr = sh_ptr1.get(); // get
 sh_ptr1.reset(new A()); // reset
 (*sh_ptr1).value = 3; // dereferencing
 sh_ptr1->value = 2; // dereferencing
}
```

A `std::weak_ptr` is simply a `std::shared_ptr` that is allowed to dangle (pointer not deallocated)

```
#include <memory>

std::shared_ptr<int> sh_ptr(new int);
std::weak_ptr<int> w_ptr = sh_ptr;

sh_ptr = nullptr;
cout << w_ptr.expired(); // print 'true'
```

It must be converted to `std::shared_ptr` in order to access the referenced object

`std::weak_ptr` methods

- `use_count()` returns the number of objects referring to the same managed object
- `reset(ptr)` replaces the managed object with `ptr`
- `expired()` checks whether the referenced object was already deleted (`true`, `false`)
- `lock()` creates a `std::shared_ptr` that manages the referenced object

```
#include <memory>

auto sh_ptr1 = std::make_shared<int>();
cout << sh_ptr1.use_count(); // print 1
std::weak_ptr<int> w_ptr = sh_ptr1;
cout << w_ptr.use_count(); // print 1

auto sh_ptr2 = w_ptr.lock();
cout << w_ptr.use_count(); // print 2 (sh_ptr1 + sh_ptr2)

sh_ptr1 = nullptr;
cout << w_ptr.expired(); // print false
sh_ptr2 = nullptr;
cout << w_ptr.expired(); // print true
```



# Concurrency

---

# Overview

C++11 introduces the Concurrency library to simplify managing OS threads

```
#include <iostream>
#include <thread>

void f() {
 std::cout << "first thread" << std::endl;
}

int main(){
 std::thread th(f);
 th.join(); // stop the main thread until "th" complete
}
```

How to compile:

```
$g++ -std=c++11 main.cpp -pthread
```

# Example

```
#include <iostream>
#include <thread>
#include <vector>
void f(int id) {
 std::cout << "thread " << id << std::endl;
}
int main() {
 std::vector<std::thread> thread_vect; // thread vector
 for (int i = 0; i < 10; i++)
 thread_vect.push_back(std::thread(&f, i));

 for (auto& th : thread_vect)
 th.join();

 thread_vect.clear();
 for (int i = 0; i < 10; i++) { // thread + lambda expression
 thread_vect.push_back(
 std::thread([](){ std::cout << "thread\n"; }));
 }
}
```

## Library methods:

- `std::this_thread::get_id()` returns the thread id
- `std::thread::sleep_for( sleep_duration )`  
Blocks the execution of the current thread for at least the specified `sleep_duration`
- `std::thread::hardware_concurrency()` returns the number of concurrent threads supported by the implementation

## Thread object methods:

- `get_id()` returns the thread id
- `join()` waits for a thread to finish its execution
- `detach()` permits the thread to execute independently of the thread handle

```
#include <chrono> // the following program should (not deterministic)
#include <iostream> // produces the output:
#include <thread> // child thread exit
// main thread exit

int main() {
 using namespace std::chrono_literals;
 std::cout << std::this_thread::get_id();
 std::cout << std::thread::hardware_concurrency(); // e.g. print 6

 auto lambda = []() {
 std::this_thread::sleep_for(1s); // t2
 std::cout << "child thread exit\n";
 };
 std::thread child(lambda);
 child.detach(); // without detach(), child must join() the
 // main thread (run-time error otherwise)
 std::this_thread::sleep_for(2s); // t1
 std::cout << "main thread exit\n";
}
// if t1 < t2 the should program prints:
```

# Parameters Passing

Parameters passing *by-value* or *by-pointer* to a thread function works in the same way of a standard function. *Pass-by-reference* requires a special wrapper ( `std::ref` , `std::cref` ) to avoid wrong behaviors

```
#include <iostream>
#include <thread>
void f(int& a, const int& b) {
 a = 7;
 const_cast<int&>(b) = 8;
}
int main() {
 int a = 1, b = 2;
 std::thread th1(f, a, b); // wrong!!!
 std::cout << a << ", " << b << std::endl; // print 1, 2!!

 std::thread th2(f, std::ref(a), std::cref(b)); // correct
 std::cout << a << ", " << b << std::endl; // print 7, 8!!
 th1.join(); th2.join();
}
```

The following code produces (in general) a value  $< 1000$ :

```
#include <chrono>
#include <iostream>
#include <thread>
#include <vector>

void f(int& value) {
 for (int i = 0; i < 10; i++) {
 value++;
 std::this_thread::sleep_for(std::chrono::milliseconds(10));
 }
}

int main() {
 int value = 0;
 std::vector<std::thread> th_vect;
 for (int i = 0; i < 100; i++)
 th_vect.push_back(std::thread(f, std::ref(value)));
 for (auto& it : th_vect)
 it.join();
 std::cout << value;
}
```

C++11 provides the `mutex` class as synchronization primitive to protect shared data from being simultaneously accessed by multiple threads

`mutex` methods:

- `lock()` locks the *mutex*, blocks if the *mutex* is not available
- `try_lock()` tries to lock the *mutex*, returns if the *mutex* is not available
- `unlock()` unlocks the *mutex*

More advanced mutex can be found here: [en.cppreference.com/w/cpp/thread](http://en.cppreference.com/w/cpp/thread)

C++ includes three mutex wrappers to provide safe copyable/movable objects:

- `lock_guard` (C++11) implements a strictly scope-based mutex ownership wrapper
- `unique_lock` (C++11) implements movable mutex ownership wrapper
- `shared_lock` (C++14) implements movable shared mutex ownership wrapper



```
#include <thread> // iostream, vector, chrono

void f(int& value, std::mutex& m) {
 for (int i = 0; i < 10; i++) {
 m.lock();
 value++; // other threads must wait
 m.unlock();
 std::this_thread::sleep_for(std::chrono::milliseconds(10));
 }
}

int main() {
 std::mutex m;
 int value = 0;
 std::vector<std::thread> th_vect;
 for (int i = 0; i < 100; i++)
 th_vect.push_back(std::thread(f, std::ref(value), std::ref(m)));
 for (auto& it : th_vect)
 it.join();
 std::cout << value;
}
```

# Atomic

`std::atomic` (C++11) class template defines an atomic type that are implemented with lock-free operations (much faster than locks)

```
#include <atomic> // chrono, iostream, thread, vector
void f(std::atomic<int>& value) {
 for (int i = 0; i < 10; i++) {
 value++;
 std::this_thread::sleep_for(std::chrono::milliseconds(10));
 }
}
int main() {
 std::atomic<int> value(0);
 std::vector<std::thread> th_vect;
 for (int i = 0; i < 100; i++)
 th_vect.push_back(std::thread(f, std::ref(value)));
 for (auto& it : th_vect)
 it.join();
 std::cout << value; // print 1000
}
```

The `future` library provides facilities to obtain values that are returned and to catch exceptions that are thrown by *asynchronous* tasks

Asynchronous call: `std::future async(function, args...)`  
runs a function asynchronously (potentially in a new thread)  
and returns a `std::future` object that will hold the result

`std::future` methods:

- `T get()` returns the result
- `wait()` waits for the result to become available

`async()` can be called with two launch policies for a task executed:

- `std::launch::async` a new thread is launched to execute the task asynchronously
- `std::launch::deferred` the task is executed on the calling thread the first time its result is requested (lazy evaluation)

```
#include <future> // numeric, algorithm, vector, iostream
template <typename RandomIt>
int parallel_sum(RandomIt beg, RandomIt end) {
 auto len = end - beg;
 if (len < 1000) // base case
 return std::accumulate(beg, end, 0);

 RandomIt mid = beg + len / 2;
 auto handle = std::async(std::launch::async, // right side
 parallel_sum<RandomIt>, mid, end);
 int sum = parallel_sum(beg, mid); // left side
 return sum + handle.get(); // left + right
}

int main() {
 std::vector<int> v(10000, 1); // init all to 1
 std::cout << "The sum is " << parallel_sum(v.begin(), v.end());
}
```

# Modern C++ Programming

## 21. PERFORMANCE OPTIMIZATION I BASIC CONCEPTS

---

*Federico Busato*

2024-11-05

## **1** Introduction

- Moore's Law
- Moore's Law Limitations
- Reasons for Optimizing

## 2 Basic Concepts

- Asymptotic Complexity
- Time-Memory Trade-off
- Developing Cycle
- Ahmdal's Law
- Throughput, Bandwidth, Latency
- Performance Bounds
- Arithmetic Intensity

## **3** Basic Architecture Concepts

- Instruction Throughput (IPC), In-Order, and Out-of-Order Execution
- Instruction Pipelining
- Instruction-Level Parallelism (ILP)
- Little's Law
- Data-Level Parallelism (DLP) and Vector Instructions (SIMD)
- Thread-Level Parallelism (TLP)
- Single Instruction Multiple Threads (SIMT)
- RISC, CISC Instruction Sets



## **4** Memory Concepts

- Memory Hierarchy Concepts
- Memory Locality
- Core-to-Core Latency and Thread Affinity
- Memory Ordering Model

# Introduction

---

# Performance and Technological Progress

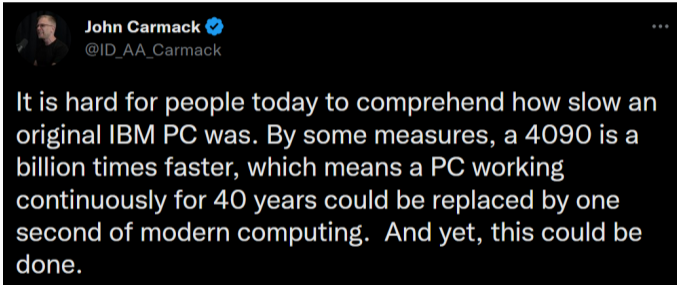

# Performance and Technological Progress

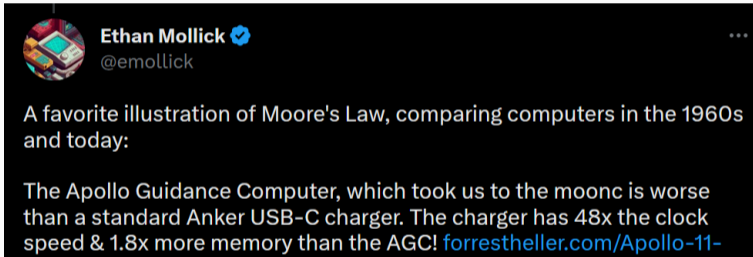

*"The number of transistors incorporated in a chip will approximately double every 24 months." (40% per year)*

**Gordon Moore, Intel co-founder**

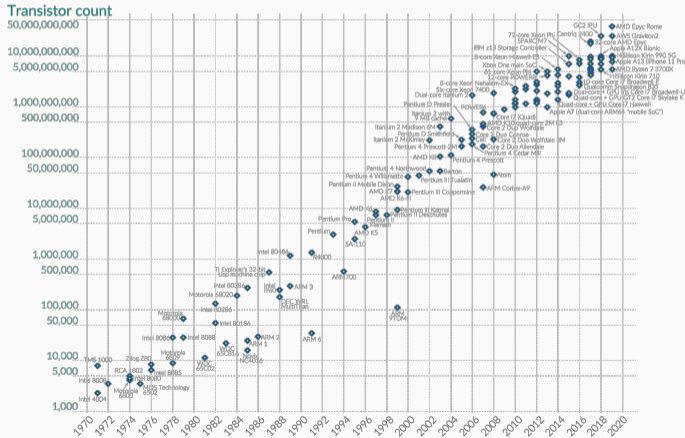

The Moore's Law is not (yet) dead, but the same concept is not true for *clock frequency, single-thread performance, power consumption, and cost*

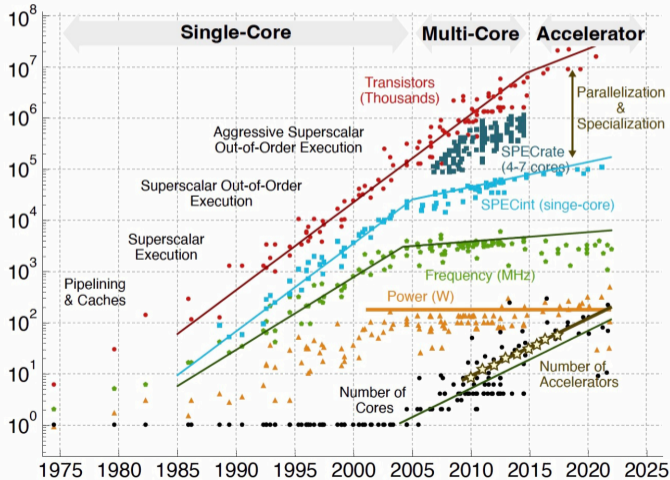

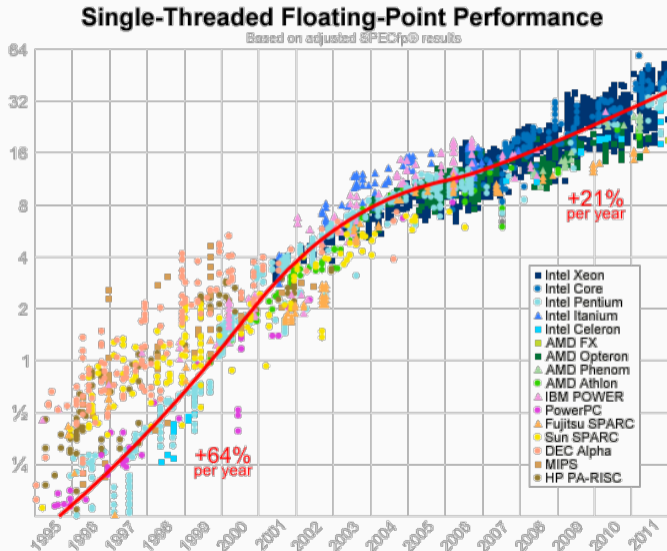

# Single-Thread Performance Trend



*Higher performance over time is not merely dictated by the number of transistors.*

Specific hardware improvements, software engineering, and algorithms play a crucial rule in driving the computer performance.

|             |                                                                                    |                                                                                    |                                                                                     |
|-------------|------------------------------------------------------------------------------------|------------------------------------------------------------------------------------|-------------------------------------------------------------------------------------|
| Technology  | <pre>01010011 01100011 01101001 01100101 01101110 01100011 01100101 00000000</pre> |  |  |
|             | <b>Software</b>                                                                    | <b>Algorithms</b>                                                                  | <b>Hardware architecture</b>                                                        |
| Opportunity | Software performance engineering                                                   | New algorithms                                                                     | Hardware streamlining                                                               |
| Examples    | Removing software bloat<br>Tailoring software to hardware features                 | New problem domains<br>New machine models                                          | Processor simplification<br>Domain specialization                                   |



## Specialized Hardware

*Reduced precision, matrix multiplication engine, and sparsity provided orders of magnitude performance improvement for AI applications*

## **Forget Moore's Law. Algorithms drive technology forward**

*"Algorithmic improvements make more efficient use of existing resources and allow computers to do a task faster, cheaper, or both. Think of how easy the smaller MP3 format made music storage and transfer. That compression was because of an algorithm."*

- 
- There's plenty of room at the Top: What will drive computer performance after Moore's law?
  - Forget Moore's Law
  - Heeding Huang's Law

Poisson's equation solver on a cube of size  $N = n^3$

| Year | Method      | Reference               | Storage | Complexity        |
|------|-------------|-------------------------|---------|-------------------|
| 1947 | GE (banded) | Von Neumann & Goldstine | $n^5$   | $\rightarrow n^7$ |
| 1950 | Optimal SOR | Reid                    | $n^3$   | $n^4 \log n$      |
| 1971 | CG          | Young                   | $n^3$   | $n^{3.5} \log n$  |
| 1984 | MG          | Brandt                  | $n^3$   | $\rightarrow n^3$ |

## Reasons for Optimizing

- In the first decades, the *computer performance was extremely limited*. Low-level optimizations were essential to fully exploit the hardware
- Modern systems provide much higher performance, but *we cannot more rely on hardware improvement* on short-period
- Performance and efficiency add market value (fast program for a given task), e.g. search, page loading, etc.
- Optimized code uses less resources, e.g. in a program that runs on a server for months or years, a small reduction in the execution time/power consumption translates in a big saving of power consumption

## Going the Other Way

- Computing systems are unfathomably complex
- Optimization is complicated and surprising
- Doing something sensible had opposite effect
- We often try clever things that don't work
  
- How about trying something silly then?

25 / 72

from *"Speed is Found in the Minds of People"*,  
**Andrei Alexandrescu**, CppCon 2019

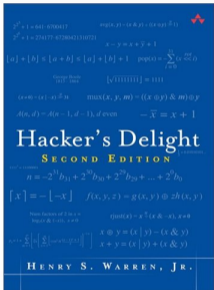

**Hacker's Delight (2nd)**

*H. S. Warren, 2016*

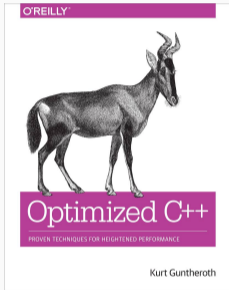

**Optimized C++**

*K. Guntheroth, 2014*

# References

- `Awesome C/C++ performance optimization resources`, *Bartłomiej Filipek*
- `Optimizing C++`, *wikibook*
- `Optimizing software in C++`, *Agner Fog*
- `Algorithmica: Algorithms for Modern Hardware`
- `What scientists must know about hardware to write fast code`

---

## Figure references

- `A Look Back at Single-Threaded CPU Performance`
- `Herb Sutter, The Free Lunch Is Over`
- `Genomic Analysis at Scale: Mapping Irregular Computations to Advanced Architectures`
- `microprocessor-trend-data`
- `What is Moore's Law?`

# Basic Concepts

---

The **asymptotic analysis** refers to estimate the execution time or memory usage as function of the input size (the *order of growing*)

The *asymptotic behavior* is opposed to a *low-level analysis* of the code (instruction/loop counting/weighting, cache accesses, etc.)

## Drawbacks:

- The *worst-case* is not the *average-case*
- Asymptotic complexity does not consider small inputs (think to *insertion sort*)
- The hidden constant can be relevant in practice
- Asymptotic complexity does not consider instructions cost and hardware details



Be aware that only **real-world problems** with a small asymptotic complexity or small size can be solved in a “*user*” *acceptable time*

Three examples:

- *Sorting*:  $\mathcal{O}(n \log n)$ , try to sort an array of some billion elements
- *Diameter of a (sparse) graph*:  $\mathcal{O}(V^2)$ , just for graphs with a few hundred thousand vertices it becomes impractical without advanced techniques
- *Matrix multiplication*:  $\mathcal{O}(N^3)$ , even for small sizes  $N$  (e.g. 8K, 16K), it requires special accelerators (e.g. GPU, TPU, etc.) for achieving acceptable performance

# Time-Memory Trade-off

The **time-memory trade-off** is a way of solving a problem or calculation in less time by using more storage space (less often the opposite direction)

Examples:

- *Memoization* (e.g. used in dynamic programming): returning the cached result when the same inputs occur again
- *Hash table*: number of entries vs. efficiency
- *Lookup tables*: precomputed data instead branches
- *Uncompressed data*: bitmap image vs. jpeg

*“If you’re not writing a program, don’t use a programming language”*

**Leslie Lamport**, Turing Award

*“First solve the problem, then write the code”*

*“Inside every large program is an algorithm trying to get out”*

**Tony Hoare**, Turing Award

*“Premature optimization is the root of all evil”*

**Donald Knuth**, Turing Award

*“Code for correctness first, then optimize!”*

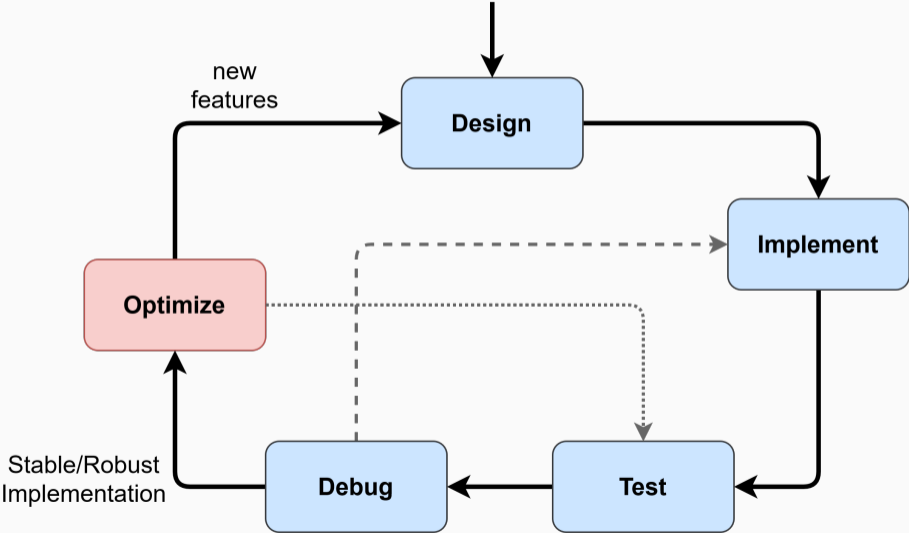

- One of the most important phase of the optimization cycle is the **application profiling** for finding regions of code that are *critical for performance* (**hotspot**)
  - Expensive code region (absolute)
  - Code regions executed many times (cumulative)
- Most of the time, **there is no the perfect algorithm for all cases** (e.g. insertion, merge, radix sort). Optimizing also refers in finding the correct heuristics for different program inputs/platforms instead of modifying the existing code

**Ahmdal's Law**

The **Ahmdal's law** expresses the maximum improvement possible by improving a particular part of a system

*Observation:* The performance of any system is constrained by the speed of the slowest point

$S$  : improvement factor expressed as a factor of  $P$

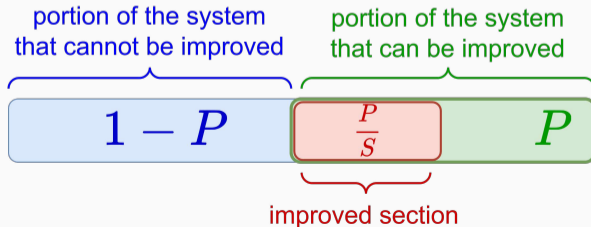

$$\text{Overall Improvement} = \frac{1}{(1 - P) + \frac{P}{S}}$$

| P \ S | 25%   | 50%   | 75%   | 2x    | 3x    | 4x    | 5x    | 10x   | ∞      |
|-------|-------|-------|-------|-------|-------|-------|-------|-------|--------|
| 10%   | 1.02x | 1.03x | 1.04x | 1.05x | 1.07x | 1.08x | 1.09x | 1.10x | 1.11x  |
| 20%   | 1.04x | 1.07x | 1.09x | 1.11x | 1.15x | 1.18x | 1.19x | 1.22x | 1.25x  |
| 30%   | 1.06x | 1.11x | 1.15x | 1.18x | 1.25x | 1.29x | 1.31x | 1.37x | 1.49x  |
| 40%   | 1.09x | 1.15x | 1.20x | 1.25x | 1.36x | 1.43x | 1.47x | 1.56x | 1.67x  |
| 50%   | 1.11x | 1.20x | 1.27x | 1.33x | 1.50x | 1.60x | 1.66x | 1.82x | 2.00x  |
| 60%   | 1.37x | 1.25x | 1.35x | 1.43x | 1.67x | 1.82x | 1.92x | 2.17x | 2.50x  |
| 70%   | 1.16x | 1.30x | 1.43x | 1.54x | 1.88x | 2.10x | 2.27x | 2.70x | 3.33x  |
| 80%   | 1.19x | 1.36x | 1.52x | 1.67x | 2.14x | 2.50x | 2.78x | 3.57x | 5.00x  |
| 90%   | 1.22x | 1.43x | 1.63x | 1.82x | 2.50x | 3.08x | 3.57x | 5.26x | 10.00x |

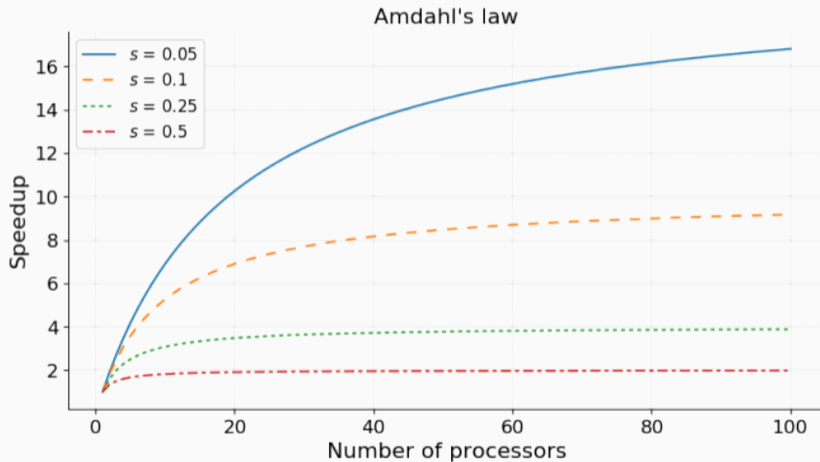

note:  $s$  is the portion of the system that cannot be improved



# Throughput, Bandwidth, Latency

The **throughput** is the rate at which operations are performed

*Peak throughput:*

$(\text{CPU speed in Hz}) \times (\text{CPU instructions per cycle}) \times$   
 $(\text{number of CPU cores}) \times (\text{number of CPUs per node})$

NOTE: modern processors have more than one computation unit

The **memory bandwidth** is the amount of data that can be loaded from or stored into a particular memory space

*Peak bandwidth:*

$(\text{Frequency in Hz}) \times (\text{Bus width in bit} / 8) \times (\text{Pump rate, memory type multiplier})$

The **latency** is the amount of time needed for an operation to complete

The performance of a program is *bounded* by one or more aspects of its computation. This is also strictly related to the underlying hardware

- **Memory-bound.** The program spends its time primarily in performing *memory accesses*. The performance is limited by the *memory bandwidth* (rarely memory-bound also refers to the amount of memory available)
- **Compute-bound** (Math-bound). The program spends its time primarily in computing *arithmetic instructions*. The performance is limited by the *speed of the CPU*

- **Latency-bound.** The program spends its time primarily in waiting *the data are ready* (instruction/memory dependencies). The performance is limited by the *latency of the CPU/memory*
- **I/O Bound.** The program spends its time primarily in performing *I/O operations* (network, user input, storage, etc.). The performance is limited by the *speed of the I/O subsystem*

## Arithmetic Intensity

**Arithmetic/Operational Intensity** is the ratio of total operations to total data movement (bytes or words)

The **arithmetic intensity** is a fundamental metric to understand the performance limitations of a system, namely *compute-bound* or *memory-bound*

The **roofline model** uses the *arithmetic intensity* to visually assess the performance of a system and the algorithms/implementations that execute on it

The naive matrix multiplication algorithm requires  $N^3 \cdot 2$  floating-point operations\* (multiplication + addition) and operates on  $(N^2 \cdot 4B) \cdot 3$  data

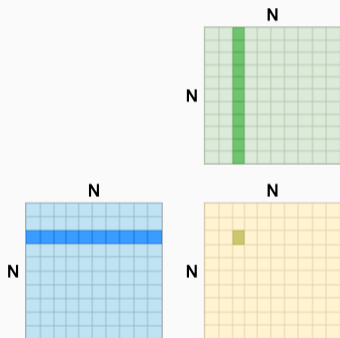

Considering an ideal system, where each matrix entry is accessed only once, and `float` data type

$$R = \frac{\text{ops}}{\text{bytes}} = \frac{2N^3}{12N^2} = \frac{N}{6}$$

which means that for every byte accessed, the algorithm performs  $\frac{N}{6}$  operations  $\rightarrow$  **compute-bound**

---

\* What Is a Flop?

Assuming  $N$  a large value ( $N * N \gg$  cache size), the basic algorithm is equivalent to a dot product for each entry of the output matrix. The algorithm performs  $2N^3$  operations and involves  $N^3 * 4B$  data movement (excluding storing the results on C)

```
for (int i = 0; i < N; i++) {
 for (int j = 0; j < N; j++) {
 float sum = 0;
 for (int k = 0; k < N; k++)
 sum += A[i][k] * B[k][j]; // row-major order
 C[i][j] = sum;
 }
}
```

$$\frac{\text{ops}}{\text{bytes}} = \frac{2N^3}{12N^3} = \frac{1}{6} \rightarrow \text{memory-bound}$$

One of the main optimizations in matrix multiplication is to organize the computation by partitioning the matrices into **blocks** (or **tiles**). The primary goal is to take advantage of the memory hierarchy to improve *data locality*

While blocked matrix multiplication doesn't change the number of operations, it *significantly reduces data movement* out of main memory

By selecting blocks of optimal size, we can reduce the data movement by a factor proportional to the block size. The computation can be viewed as a sequence of dot products, one for each block in the output matrix

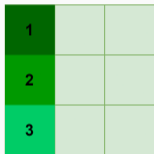

Considering an optimal block size  $B$  to fully exploit the caches

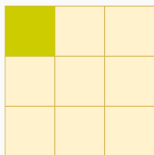

$$\frac{\text{ops}}{\text{bytes}} = \frac{2N^3}{12\left(\frac{N}{B}\right)^3} = \frac{B^3}{6} \rightarrow \text{compute-bound}$$



| N     | Operations        | Data Movement | Ratio | Exec. Time |
|-------|-------------------|---------------|-------|------------|
| 512   | $268 \cdot 10^6$  | 3 MB          | 85    | 2 ms       |
| 1024  | $2 \cdot 10^9$    | 12 MB         | 170   | 21 ms      |
| 2048  | $17 \cdot 10^9$   | 50 MB         | 341   | 170 ms     |
| 4096  | $137 \cdot 10^9$  | 201 MB        | 682   | 1.3 s      |
| 8192  | $1 \cdot 10^{12}$ | 806 MB        | 1365  | 11 s       |
| 16384 | $9 \cdot 10^{12}$ | 3 GB          | 2730  | 90 s       |

A modern CPU performs 100 GFlops, and has about 50 GB/s memory bandwidth

# Basic Architecture Concepts

---

## Instruction Throughput (IPC), In-Order, and Out-of-Order Execution

The *processor throughput*, namely the number of instructions that can be executed in a unit of time, is measured in **Instruction per Cycle (IPC)**.

It is worth noting that most instructions require multiple clock cycles (**Cycles Per Instruction, CPI**). Therefore improving the IPC requires advanced hardware support

**In-Order Execution (IOE)** refers to the sequential processing of instructions in the exact order they appear in the program

**Out-of-Order Execution (OOE)** refers to the execution of instructions based on the availability of input data and execution units, rather than their original order in a program executed in a unit of time

*Out-of-order execution on a scalar processor* (single instruction at a time) is implemented through **instruction pipelining** which consists in dividing instructions into stages performed by different processor units, allowing different parts of instructions to be processed in parallel

*Instruction pipelining breaks up the processing of instructions into several steps, allowing the processor to avoid stalls that occur when the data needed to execute an instruction is not immediately available. The processor avoid stalls by filling slots with other instructions that are ready*

**Fetch:** The processor retrieves an instruction from memory

**Decode:** Instruction interpretation and preparation for execution, determining what operations it calls for

**Execute:** The processor carries out the instruction

**Memory Access:** Reading from or writing to memory (if needed)

**Write-back:** The results of the instruction execution are written back to the processor's registers or memory

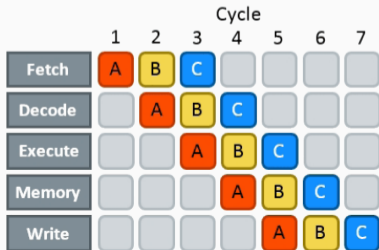

| Microarchitecture | Pipeline stages |
|-------------------|-----------------|
| Core              | 14              |
| Bonnell           | 16              |
| Sandy Bridge      | 14              |
| Silvermont        | 14 to 17        |
| Haswell           | 14              |
| Skylake           | 14              |
| Kabylake          | 14              |

The *pipeline efficiency* is affected by

- **Instruction stalls**, e.g. cache miss, an execution unit not available, etc.
- **Bad speculation**, branch misprediction

A **superscalar processor** is a type of microprocessor architecture that allows for the execution of *multiple instructions in parallel during a single clock cycle*. This is achieved by incorporating multiple execution units within the processor

The concept should not be confused with *instruction pipelining*, which decompose the instruction processing in stages. Modern processors combine both techniques to improve the IPC

**Instruction-Level Parallelism (ILP)** is a measure of how many instructions in a program can be executed simultaneously by issuing *independent* instructions in sequence.

*ILP* is achieved with *out-of-order execution* or with the *SIMT* programming model (see next slides)

```
for (int i = 0; i < N; i++) // with no optimizations, the loop
 C[i] = A[i] * B[i]; // is executed in sequence
```

can be rewritten as:

```
for (int i = 0; i < N; i += 4) { // four independent multiplications
 C[i] = A[i] * B[i]; // per iteration
 C[i + 1] = A[i + 1] * B[i + 1]; // A, B, C are not alias
 C[i + 2] = A[i + 2] * B[i + 2];
 C[i + 3] = A[i + 3] * B[i + 3];
}
```



## Instruction-Level Parallelism and Little's Law

The **Little's Law** expresses the relation between *latency* and *throughput*. The *throughput* of a system  $\lambda$  is equal to the number of elements in the system divided by the average time spent (*latency*)  $W$  for each element in the system:

$$L = \lambda W \quad \rightarrow \quad \lambda = \frac{L}{W}$$

- $L$ : average number of customers in a store
- $\lambda$ : arrival rate (*throughput*)
- $W$ : average time spent (*latency*)

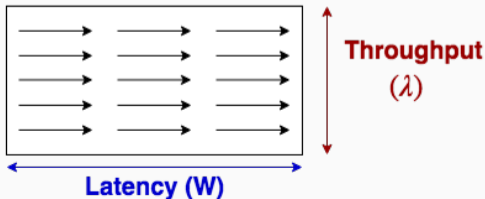

## Data-Level Parallelism (DLP) and Vector Instructions (SIMD)

**Data-Level Parallelism (DLP)** refers to the execution of the same operation on multiple data in parallel

*Vector processors or array processors* provide SIMD (*Single Instruction-Multiple Data*) or vector instructions for exploiting data-level parallelism

The popular vector instruction sets are:

**MMX** *MultiMedia eXtension*. 80-bit width (Intel, AMD)

**SSE** (SSE2, SSE3, SSE4) *Streaming SIMD Extensions*. 128-bit width (Intel, AMD)

**AVX** (AVX, AVX2, AVX-512) *Advanced Vector Extensions*. 512-bit width (Intel, AMD)

**NEON** *Media Processing Engine*. 128-bit width (ARM)

**SVE** (SVE, SVE2) *Scalable Vector Extension*. 128-2048 bit width (ARM)

## Thread-Level Parallelism (TLP)

A **thread** is a single sequential execution flow within a program with its state (instructions, data, PC, register state, and so on)

**Thread-level parallelism (TLP)** refers to the execution of separate computation “*thread*” on different processing units (e.g. CPU cores)

## Single Instruction Multiple Threads (SIMT)

An alternative approach to the classical data-level parallelism is **Single Instruction Multiple Threads (SIMT)**, where multiple threads execute the same instruction simultaneously, with each thread operating on different data.

GPUs are successful examples of SIMT architectures.

**SIMT** can be thought of as an evolution of *SIMD* (Single Instruction Multiple Data). *SIMD* requires that all data processed by the instruction be of the same type and requires no dependencies or inter-thread communication. On the other hand, **SIMT** is more flexible and does not have these restrictions. Each thread has access to its own memory and can operate independently.

The **Instruction Set Architecture** (ISA) is an abstract model of the CPU to represent its behavior. It consists of addressing modes, instructions, data types, registers, memory architecture, interrupt, etc.

It does not define how an instruction is processed

The **microarchitecture** ( $\mu$ arch) is the implementation of an **ISA** which includes pipelines, caches, etc.

## Complex Instruction Set Computer (CISC)

- Complex instructions for special tasks even if used infrequently
- Assembly instructions follow software. Little compiler effort for translating high-level language into assembly
- Initially designed for saving cost of computer memory and disk storage (1960)
- High number of instructions with different size
- Instructions require complex micro-ops decoding (translation) for exploiting ILP
- Multiple low-level instructions per clock but with high latency

### *Hardware implications*

- High number of transistors
- Extra logic for decoding. Heat dissipation
- Hard to scale

## Reduced Instruction Set Computer (RISC)

- Simple instructions
- Small number of instructions with fixed size
- 1 clock per instruction
- Assembly instructions does not follow software
- No instruction decoding

### *Hardware implications*

- High ILP, easy to schedule
- Small number of transistors
- Little power consumption
- Easy to scale

# Instruction Set Comparison

## x86 Instruction set

```
MOV AX, 15; AH = 00, AL = 0Fh
AAA; AH = 01, AL = 05
RET
```

## ARM Instruction set

```
MOV R3, # 10
AND R2, R0, # 0xF
CMP R2, R3
IT LT
BLT elsebranch
ADD R2, # 6
ADD R1, #1
elsebranch:
END
```



# CISC vs. RISC

- **Hardware market:**

- *RISC* (ARM, IBM): Qualcomm Snapdragon, Amazon Graviton, Nvidia Grace, Nintendo Switch, Fujitsu Fukaku, Apple M1, Apple Iphone/Ipod/Mac, Tesla Full Self-Driving Chip, PowerPC
- *CISC* (Intel, AMD): all x86-64 processors

- **Software market:**

- *RISC*: Android, Linux, Apple OS, Windows
- *CISC*: Windows, Linux

- **Power consumption:**

- *CISC*: Intel i5 10th Generation: 64W
- *RISC*: Arm-based smartphone < 5W

*“Incidentally, the first ARM1 chips required so little power, when the first one from the factory was plugged into the development system to test it, the microprocessor immediately sprung to life by drawing current from the IO interface – before its own power supply could be properly connected.”*

---

Happy birthday, ARM1. It is 35 years since Britain's Acorn RISC Machine chip sipped power for the first time

# Memory Concepts

---

## Access to memory dominates other costs in a processor

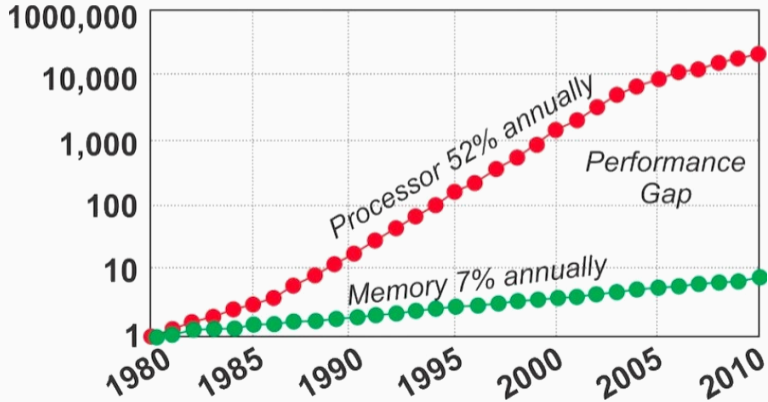

# The Von Neumann Bottleneck

The efficiency of computer architectures is limited by the **Memory Wall** problem, namely the memory is the slowest part of the system

Moving data to and from main memory consumes the vast majority of *time* and *energy* of the system



**John Carmack** ✓

@ID\_AA\_Carmack



An A100 GPU has 2 TB/s main memory bandwidth, an even million times the 2 MB/s bandwidth of an original Apple 2. Computation is a billion times higher, which is why we have cache hierarchies.

Modern architectures rely on complex memory hierarchy (primary memory, caches, registers, scratchpad memory, etc.). Each level has different characteristics and constrains (size, latency, bandwidth, concurrent accesses, etc.)



*1 byte of RAM (1946)*



*IBM 5MB hard drive (1956)*

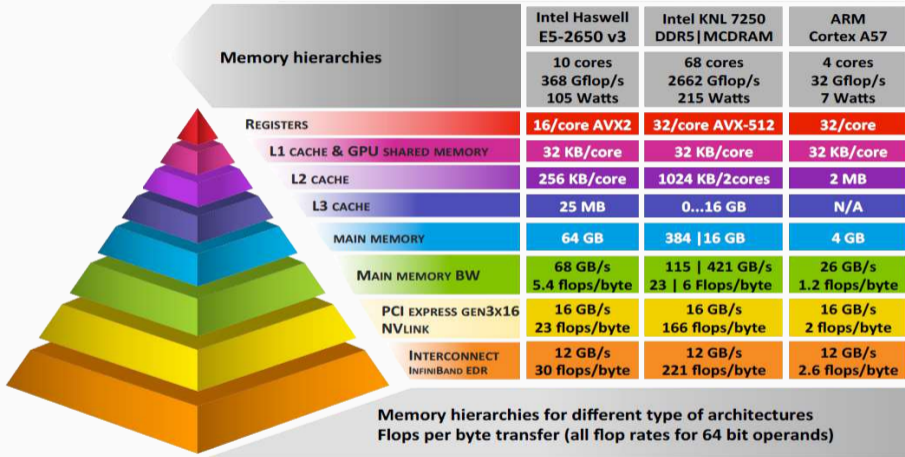

Source:

*“Accelerating Linear Algebra on Small Matrices from Batched BLAS to Large Scale Solvers”,  
ICL, University of Tennessee*



Intel Alder Lake 12th-gen Core-i9-12900k (Q1'21) + DDR4-3733 example:

| Hierarchy level | Size   | Latency    | Latency Ratio     | Bandwidth  | Bandwidth Ratio |
|-----------------|--------|------------|-------------------|------------|-----------------|
| L1 cache        | 192 KB | 1 ns       | 1.0x              | 1,600 GB/s | 1.0x            |
| L2 cache        | 1.5 MB | 3 ns       | 3x                | 1,200 GB/s | 1.3x            |
| L3 cache        | 12 MB  | 6 - 20 ns  | 6-20x             | 900 GB/s   | 1.7x            |
| DRAM            | /      | 50 - 90 ns | 50-90x            | 80 GB/s    | 20x             |
| SDD Disk (swap) | /      | 70 $\mu$ s | 10 <sup>5</sup> x | 2 GB/s     | 800x            |
| HDD Disk (swap) | /      | 10 ms      | 10 <sup>7</sup> x | 2 GB/s     | 800x            |

- [en.wikichip.org/wiki/WikiChip](https://en.wikichip.org/wiki/WikiChip)
- Memory Bandwidth Napkin Math

*“Thinking differently about memory accesses, a good start is to get rid of the idea of  $\mathcal{O}(1)$  memory access and replace it with  $\mathcal{O}\sqrt{N}$ ” - The Myth of RAM*

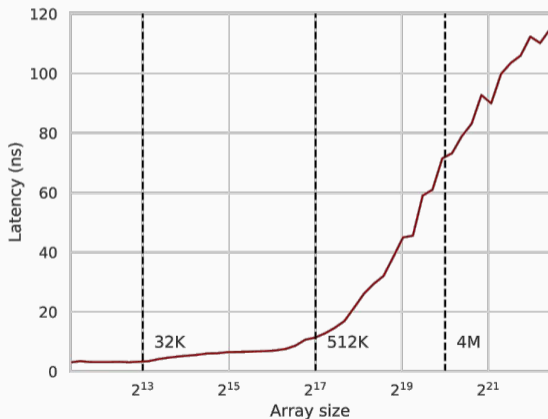

A **cache** is a small and fast memory located close to the processor that stores frequently used instructions and data. It is part of the processor package and takes 40 to 60 percent of the chip area

*Characteristics and content:*

**Registers** Program counter (PC), General purpose registers, Instruction Register (IR), etc.

**L1 Cache** Instruction cache and data cache, private/exclusive per CPU core, located on-chip

**L2 Cache** Private/exclusive per single CPU core or a cluster of cores, located off-chip

**L3 Cache** Shared between all cores and located off-chip (e.g. motherboard), up to 128/256MB

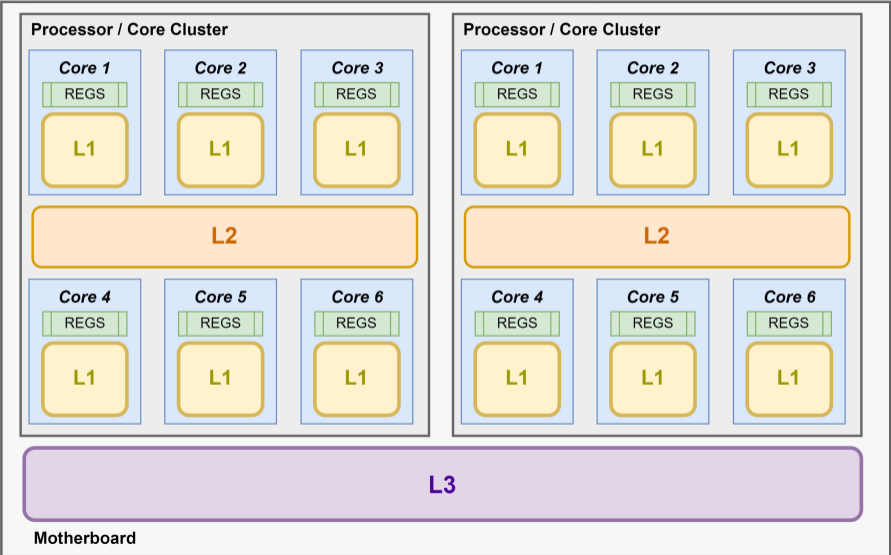

A **cache line** or **cache block** is the unit of data transfer between the cache and main memory, namely the memory is loaded at the *granularity* of a cache line. A cache line can be further organized in banks or sectors

The typical size of the cache line is 64 bytes on x86-64 architectures (Intel, AMD), while it is 128 bytes on Arm64

*Cache access type:*

**Hot** Closest-processor cached, L1

**Warm** L2 or L3 caches

**Cold** First load, cache empty

- A **cache hit** occurs when a requested data is *successfully found* in the cache memory
- The **cache hit rate** is the number of *cache hits divided by the number of memory requests*
- A **cache miss** occurs when a requested data is *not found* in the cache memory
- The **miss penalty** refers to the *extra time required to load the data* into cache from the main memory when a cache miss occurs
- A **page fault** occurs when a requested data is in the process address space, but *it is not currently located in the main memory* (swap/pagefile)
- Page **thrashing** occurs when page faults are frequent and the OS spends significant time to swap data in and out the physical RAM

# Memory Locality

- **Spatial Locality** refers to the use of data elements within relatively close storage locations e.g. scan arrays in increasing order, matrices by row. It involves mechanisms such as *memory prefetching* and *access granularity*  
When spatial locality is low, many words in the cache line are not used
- **Temporal Locality** refers to the reuse of the same data within a relatively small-time duration, and, as consequence, exploit lower levels of the memory hierarchy (caches), e.g. multiple sparse accesses  
*Heavily used memory locations can be accessed more quickly than less heavily used locations*

# Core-to-Core Latency

The slowing of Moore's Law and the collapse of Dennard scaling necessitated the hierarchical organization of caches and processors in the CPU. *Today, CPUs organize their cores into clusters, chipllets, and multi-sockets.* As a result, how execution threads are mapped to cores has a significant impact on the overall performance

Core-to-Core  
Latency Heatmap:

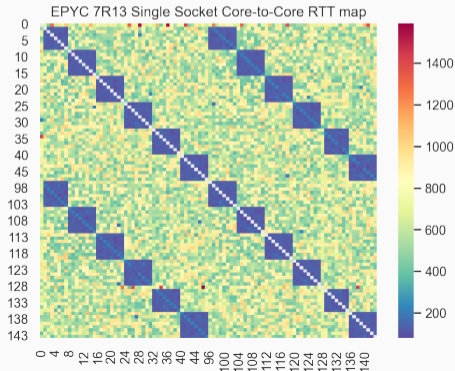



# Thread Affinity

The **thread affinity** refers to the binding of a thread to a specific execution unit. The goal of *thread affinity* is improving the application performance by taking advantage of cache locality and optimizing resource usage

Setting CPU affinity can be done programmatically, such as using the `pthread_setaffinity_np` function for POSIX threads, or at OS level with the `taskset` command and the `sched_setaffinity` system call on Linux

---

\***Dennard Scaling**: power is proportional to the area of the transistor

CPU Affinity: Because Even A Single Chip Is Nonuniform

# Memory Ordering Model

- **Source code order:** The order in which the memory operations are specified in the source code, e.g. *subscript, dereferencing*
- **Program order:** The order in which the memory operations are specified at assembly level. Compilers can reorder instructions as part of the optimization process
- **Execution order:** The order in which the individual memory-reference instructions are executed on a given CPU, e.g., *out-of-order execution*
- **Perceived order:** The order in which a CPU perceives its memory operations. The perceived order can differ from the execution order due to caching, interconnect, and memory-system optimizations

# Modern C++ Programming

## 22. PERFORMANCE OPTIMIZATION II

### CODE OPTIMIZATION

---

*Federico Busato*

2024-11-05

## 1 I/O Operations

- `printf`
- Memory Mapped I/O
- Speed Up Raw Data Loading

## 2 Memory Optimizations

- Heap Memory
- Stack Memory
- Cache Utilization
- Memory Alignment
- Memory Prefetch

## **3** Arithmetic Types

- Data Types
- Arithmetic Operations
- Conversion
- Floating-Point
- Compiler Intrinsic Functions
- Value in a Range
- Lookup Table

## 4 Control Flow

- Branches
- Branch Hints - `[[likely]]` / `[[unlikely]]`
- Signed/Unsigned Integers
- Loops
- Loop Hoisting
- Loop Unrolling
- Assertions
- Compiler Hints - `[[assume]]` / `std::unreachable()`
- Recursion

## **5** Functions

- Function Call Cost
- Argument Passing
- Function Inlining
- Function Attributes
- Pointers Aliasing

## **6** Object-Oriented Programming

## **7** Std Library and Other Language Aspects

# I/O Operations

---



**I/O Operations are orders of magnitude slower than  
memory accesses**

In general, input/output operations are one of the most expensive

- Use `endl` for `ostream` only when it is strictly necessary (prefer `\n`)
- Disable *synchronization* with `printf/scanf` :  
`std::ios_base::sync_with_stdio(false)`
- Disable IO *flushing* when mixing `istream/ostream` calls:  
`<istream_obj>.tie(nullptr);`
- Increase IO *buffer size*:  
`file.rdbuf()->pubsetbuf(buffer_var, buffer_size);`

# I/O Streams - Example

```
#include <iostream>

int main() {
 std::ifstream fin;
 // -----
 std::ios_base::sync_with_stdio(false); // sync disable
 fin.tie(nullptr); // flush disable
 // buffer increase

 const int BUFFER_SIZE = 1024 * 1024; // 1 MB
 char buffer[BUFFER_SIZE];
 fin.rdbuf()->pubsetbuf(buffer, BUFFER_SIZE);
 // -----
 fin.open(filename); // Note: open() after optimizations

 // IO operations
 fin.close();
}
```

- `printf` is faster than `ostream` (see [speed test link](#))
- A `printf` call with a simple format string ending with `\n` is converted to a `puts()` call

```
printf("Hello World\n");
printf("%s\n", string);
```

- No optimization if the string is not ending with `\n` or one or more `%` are detected in the format string

# Memory Mapped I/O

A **memory-mapped file** is a segment of virtual memory that has been assigned a direct byte-for-byte correlation with some portion of a file

## Benefits:

- Orders of magnitude faster than system calls
- Input can be “cached” in RAM memory (page/file cache)
- A file requires disk access only when a new page boundary is crossed
- Memory-mapping may bypass the page/swap file completely
- Load and store *raw* data (no parsing/conversion)

```
#if !defined(__linux__)
 #error It works only on linux
#endif
#include <fcntl.h> //::open
#include <sys/mman.h> //::mmap
#include <sys/stat.h> //::open
#include <sys/types.h> //::open
#include <unistd.h> //::lseek
// usage: ./exec <file> <byte_size> <mode>
int main(int argc, char* argv[]) {
 size_t file_size = std::stoll(argv[2]);
 auto is_read = std::string(argv[3]) == "READ";
 int fd = is_read ? ::open(argv[1], O_RDONLY) :
 ::open(argv[1], O_RDWR | O_CREAT | O_TRUNC, S_IRUSR | S_IWUSR);
 if (fd == -1)
 ERROR("::open") // try to get the last byte
 if (::lseek(fd, static_cast<off_t>(file_size - 1), SEEK_SET) == -1)
 ERROR("::lseek")
 if (!is_read && ::write(fd, "", 1) != 1) // try to write
 ERROR("::write")
}
```

```
auto mm_mode = (is_read) ? PROT_READ : PROT_WRITE;

// Open Memory Mapped file
auto mmap_ptr = static_cast<char*>(
 ::mmap(nullptr, file_size, mm_mode, MAP_SHARED, fd, 0));

if (mmap_ptr == MAP_FAILED)
 ERROR("::mmap");
// Advise sequential access
if (::madvise(mmap_ptr, file_size, MADV_SEQUENTIAL) == -1)
 ERROR("::madvise");

// MemoryMapped Operations
// read from/write to "mmap_ptr" as a normal array: mmap_ptr[i]

// Close Memory Mapped file
if (::munmap(mmap_ptr, file_size) == -1)
 ERROR("::munmap");
if (::close(fd) == -1)
 ERROR("::close");
```

Consider using optimized (low-level) numeric conversion routines:

```
template<int N, unsigned MUL, int INDEX = 0>
struct fastStringToIntStr;

inline unsigned fastStringToUnsigned(const char* str, int length) {
 switch(length) {
 case 10: return fastStringToIntStr<10, 1000000000>::aux(str);
 case 9: return fastStringToIntStr< 9, 100000000>::aux(str);
 case 8: return fastStringToIntStr< 8, 10000000>::aux(str);
 case 7: return fastStringToIntStr< 7, 1000000>::aux(str);
 case 6: return fastStringToIntStr< 6, 100000>::aux(str);
 case 5: return fastStringToIntStr< 5, 10000>::aux(str);
 case 4: return fastStringToIntStr< 4, 1000>::aux(str);
 case 3: return fastStringToIntStr< 3, 100>::aux(str);
 case 2: return fastStringToIntStr< 2, 10>::aux(str);
 case 1: return fastStringToIntStr< 1, 1>::aux(str);
 default: return 0;
 }
}
```



```
template<int N, unsigned MUL, int INDEX>
struct fastStringToIntStr {
 static inline unsigned aux(const char* str) {
 return static_cast<unsigned>(str[INDEX] - '0') * MUL +
 fastStringToIntStr<N - 1, MUL / 10, INDEX + 1>::aux(str);
 }
};

template<unsigned MUL, int INDEX>
struct fastStringToIntStr<1, MUL, INDEX> {
 static inline unsigned aux(const char* str) {
 return static_cast<unsigned>(str[INDEX] - '0');
 }
};
```

- Hard disk is orders of magnitude slower than RAM
- Parsing is faster than data reading
- Parsing can be avoided by using *binary* storage and `mmap`
- Decreasing the number of hard disk accesses improves the performance → **compression**

**LZ4** is lossless compression algorithm providing *extremely fast decompression* up to 35% of `memcpy` and good compression ratio  
[github.com/lz4/lz4](https://github.com/lz4/lz4)

Another alternative is **Facebook zstd**  
[github.com/facebook/zstd](https://github.com/facebook/zstd)

Performance comparison of different methods for a file of 4.8 GB of integer values

| Load Method                                       | Exec. Time | Speedup |
|---------------------------------------------------|------------|---------|
| <code>ifstream</code>                             | 102 667 ms | 1.0x    |
| <code>memory mapped + parsing (first run)</code>  | 30 235 ms  | 3.4x    |
| <code>memory mapped + parsing (second run)</code> | 22 509 ms  | 4.5x    |
| <code>memory mapped + lz4 (first run)</code>      | 3 914 ms   | 26.2x   |
| <code>memory mapped + lz4 (second run)</code>     | 1 261 ms   | 81.4x   |

NOTE: the size of the Lz4 compressed file is 1,8 GB

# Memory Optimizations

---

# Heap Memory

- *Dynamic heap allocation is expensive:* implementation dependent and interact with the operating system
- *Many small heap allocations are more expensive than one large memory allocation*  
The default page size on Linux is 4 KB. For smaller/multiple sizes, C++ uses a sub-allocator
- *Allocations within the page size is faster than larger allocations (sub-allocator)*

# Stack Memory

- *Stack memory is faster than heap memory.* The stack memory provides high locality, it is small (cache fit), and its size is known at compile-time
- `static` stack allocations produce better code. It avoids filling the stack each time the function is reached
- `constexpr` arrays with dynamic indexing produces very inefficient code with GCC. Use `static constexpr` instead

```
void f(int x) {
 // bad performance with GCC
 // constexpr int array[] = {1,2,3,4,5,6,7,8,9};
 static constexpr int array[] = {1,2,3,4,5,6,7,8,9};
 return array[x];
}
```

## Maximize cache utilization:

- Maximize spatial and temporal locality (see next examples)
- Prefer small data types
- Prefer `std::vector<bool>` over array of `bool`
- Prefer `std::bitset<N>` over `std::vector<bool>` if the data size is known in advance or bounded
- Prefer *stack* data structures *instead* of *heap* data structures, e.g. `std::vector` vs. `static_vector` [↗](#)

A, B, C matrices of size  $N \times N$

$$C = A * B$$

```
for (int i = 0; i < N; i++) {
 for (int j = 0; j < N; j++) {
 int sum = 0;
 for (int k = 0; k < N; k++)
 sum += A[i][k] * B[k][j]; // row x column
 C[i][j] = sum;
 }
}
```

$$C = A * B^T$$

```
for (int i = 0; i < N; i++) {
 for (int j = 0; j < N; j++) {
 int sum = 0;
 for (int k = 0; k < N; k++)
 sum += A[i][k] * B[j][k]; // row x row
 C[i][j] = sum;
 }
}
```



## Benchmark:

| N                  | 64     | 128  | 256   | 512    | 1024     |
|--------------------|--------|------|-------|--------|----------|
| A * B              | < 1 ms | 5 ms | 29 ms | 141 ms | 1,030 ms |
| A * B <sup>T</sup> | < 1 ms | 2 ms | 6 ms  | 48 ms  | 385 ms   |
| Speedup            | /      | 2.5x | 4.8x  | 2.9x   | 2.7x     |

# Temporal-Locality Example

## Speeding up a random-access function

```
for (int i = 0; i < N; i++) // V1
 out_array[i] = in_array[hash(i)];
```

```
for (int K = 0; K < N; K += CACHE) { // V2
 for (int i = 0; i < N; i++) {
 auto x = hash(i);
 if (x >= K && x < K + CACHE)
 out_array[i] = in_array[x];
 }
}
```

V1 : 436 ms, V2 : 336 ms  $\rightarrow$  1.3x speedup (temporal locality improvement)

.. but it needs a careful evaluation of `CACHE`, and it can even decrease the performance for other sizes

pre-sorted `hash(i)` : 135 ms  $\rightarrow$  3.2x speedup (spatial locality improvement)

# Memory Alignment

**Memory alignment** refers to placing data in memory at addresses that conform to certain boundaries, typically powers of two (e.g., 1, 2, 4, 8, 16 bytes, etc.)

Note: For multidimensional data, alignment only means that the start address of the data is aligned, not that all start offsets for all dimensions are aligned., e.g. for a 2D matrix, if `row[0][0]` is aligned doesn't imply that `row[0][1]` has the same property. Also the strides between rows need to be multiple of the alignment

**Data alignment** is classified in:

- **Internal alignment** for struct/class layout optimization → reducing memory footprint, optimizing memory bandwidth, and minimizing cache-line misses
- **External alignment** across several elements of the same type → minimizing cache-line misses, vectorization (SIMD instructions)

# Internal Structure Alignment

```
struct A1 {
 char x1; // offset 0
 double y1; // offset 8!! (not 1)
 char x2; // offset 16
 double y2; // offset 24
 char x3; // offset 32
 double y3; // offset 40
 char x4; // offset 48
 double y4; // offset 56
 char x5; // offset 64 (65 bytes)
}
```

```
struct A2 { // internal alignment
 char x1; // offset 0
 char x2; // offset 1
 char x3; // offset 2
 char x4; // offset 3
 char x5; // offset 4
 double y1; // offset 8
 double y2; // offset 16
 double y3; // offset 24
 double y4; // offset 32 (40 bytes)
}
```

- (1) We are wasting 40% of memory for (A1)
- (2) Considering an *array of structures* (AoS) and a cache line of 64 bytes (x64 processors), every access to A1 involves two cache line operations (~2x slower)

In addition to internal layout problems, even the structure `A2` introduces overhead if organized in an array. Loads lead to one or two cache line operations depending on the alignment at a specific index, e.g.

`index 0` → one cache line load

`index 1` → two cache line loads

It is possible to fix the structure alignment in two ways:

- **Memory padding** refers to manually introducing extra bytes at the end of the data structure to enforce memory alignment.  
e.g. add a `char` array of size 24 to the structure `A2`
- **Align keyword or attribute** allows specifying the alignment requirement of a type or an object (next slide)

- *Explicit* alignment/padding for **variable / struct declaration** → affects `sizeof(T)`

C++11 : `alignas(N)`

GCC/Clang : `__attribute__((aligned(N)))`

MSVC : `__declspec(align(N))`

- *Explicit* alignment for **pointers**

C++20 : `std::assume_aligned<N>(ptr) (<memory>)`

C++17 : `aligned new` or `std::aligned_alloc(align, size)`

GCC/Clang : `__builtin_assume_aligned(ptr, N)`

```
struct alignas(16) S1 { // C++11
 int x, y;
};
struct __attribute__((aligned(16))) S2 { // compiler-specific attribute
 int x, y;
};
constexpr auto MaxAlign = __STDCPP_DEFAULT_NEW_ALIGNMENT__;

S1 s; // 16B alignment
alignas(16) int var[3]; // 16B alignment
auto ptr1 = new S1[10]; // Warning! no alignment guarantee

auto ptr2 = new int[100]; // alignment: max(4B, MaxAlign)
auto ptr3 = std::aligned_alloc(8, 4); // C++17, alignment: max(8B, MaxAlign)
auto ptr4 = __builtin_assume_aligned(ptr2, 16); // compiler-specific attribute
auto ptr5 = std::assume_aligned<16>(ptr2); // C++20

auto ptr = new (std::align_val_t(4)) int[2]; // C++17, max(16B, MaxAlign)
::operator delete[] (ptr, std::align_val_t{4});
```

# Memory Prefetch

`__builtin_prefetch` is used to *minimize cache-miss latency* by moving data into a cache before it is accessed. It can be used not only for improving *spatial locality*, but also *temporal locality*

```
for (int i = 0; i < size; i++) {
 auto data = array[i];
 __builtin_prefetch(array + i + 1, 0, 1); // 2nd argument, '0' means read-only
 // 3th argument, '1' means
 // temporal locality=1, default=3
 // do some computation on 'data', e.g. CRC
}
```

Alternatively, `-fprefetch-loop-arrays` can be used to emit prefetching instructions



## Multi-Threading and Caches

The **CPU/threads affinity** controls how a process is mapped and executed over multiple cores (including sockets). It affects the process performance due to core-to-core communication and cache line invalidation overhead

Maximizing threads “*clustering*” on a single core can potentially lead to higher cache hits rate and faster communication. On the other hand, if the threads work independently/almost independently, namely they show high locality on their working set, mapping them to different cores can improve the performance

# Arithmetic Types

---

## Hardware Notes

- Instruction throughput greatly depends on processor model and characteristics, e.g., there is no hardware support for integer division on GPUs. This operation is translated to 100 instructions for 64-bit operands
- Modern processors provide separated units for floating-point computation (FPU)
- *Addition, subtraction, and bitwise operations* are computed by the ALU, and they have very similar throughput
- In modern processors, *multiplication* and *addition* are computed by the same hardware component for decreasing circuit area → multiplication and addition can be fused in a single operation `fma` (floating-point) and `mad` (integer)

- **32-bit integral vs. floating-point:** in general, integral types are faster, but it depends on the processor characteristics
- **32-bit types are faster than 64-bit types**
  - 64-bit integral types are slightly slower than 32-bit integral types. Modern processors widely support native 64-bit instructions for most operations, otherwise they require multiple operations
  - Single precision floating-points are up to three times faster than double precision floating-points
- **Small integral types are slower than 32-bit integer**, but they require less memory → cache/memory efficiency

- Arithmetic increment/decrement `x++ / x--` has the same performance of `x + 1 / x - 1`
- Arithmetic compound operators (`a *= b`) has the same performance of assignment + operation (`a = a * b`) \*
- **Prefer prefix increment/decrement** (`++var`) instead of the postfix operator (`var++`) \*

---

\* the compiler automatically applies such optimization whenever possible. This is not ensured for object types

- **Keep near constant values/variables** → the compiler can merge their values
- Some operations on **unsigned types** are faster than on **signed types** because they don't have to deal with negative numbers, e.g. `x / 2 → x >> 1`
- Some operations on **signed types** are faster than on **unsigned types** because they can exploit *undefined behavior*, see next slide
- Prefer **logic operations** `||` to **bitwise operations** `|` to take advantage of short-circuiting

```
bool mainGuT(uint32_t i1, uint32_t i2, // if i1, i2 are int32_t, the code
 uint8_t *block) { // uses half of the instructions!!
 uint8_t c1, c2;
 // 1 // why? if i1, i2 are uint32_t the compiler
 c1 = block[i1], c2 = block[i2]; // must copy them into 32-bit registers to
 if (c1 != c2) return (c1 > c2); // ensure wrap-around behavior before passing
 i1++, i2++; // them to the subscript operator (size_t)

 // 2 // On the other hand, int32_t overflow is
 c1 = block[i1], c2 = block[i2]; // undefined behavior and the compiler can
 if (c1 != c2) return (c1 > c2); // assume it never happens
 i1++, i2++;
 // ... continue repeating the // the code is also optimal with size_t on 64-bit
} // code multiple times // arch because block cannot be larger than it
```

## Arithmetic Operations - Integer Multiplication

Integer multiplication requires double the number of bits of the operands

```
// 32-bit platforms

int f1(int x, int y) {
 return x * y; // efficient but can overflow
}

int64_t f2(int64_t x, int64_t y) { // same for f2(int x, int64_t y)
 return x * y; // always correct but slow
}

int64_t f3(int x, int y) {
 return x * static_cast<int64_t>(y); // correct and efficient!!
}
```



## Arithmetic Operations - Power-of-Two Multiplication/Division/Modulo

- Prefer shift for **power-of-two multiplications** ( $a \ll b$ ) and **divisions** ( $a \gg b$ ) only for run-time values \*
- Prefer bitwise AND ( $a \% b \rightarrow a \& (b - 1)$ ) for **power-of-two modulo operations** only for run-time values \*
- **Constant multiplication and division** can be heavily optimized by the compiler, even for non-trivial values

---

\* the compiler automatically applies such optimizations if  $b$  is known at compile-time. Bitwise operations make the code harder to read

Ideal divisors: when a division compiles down to just a multiplication

# Conversion

---

| From           | To              | Cost                                                                                                                                   |
|----------------|-----------------|----------------------------------------------------------------------------------------------------------------------------------------|
| Signed         | Unsigned        | no cost, bit representation is the same                                                                                                |
| Unsigned       | Larger Unsigned | no cost, register extended                                                                                                             |
| Signed         | Larger Signed   | 1 clock-cycle, register + sign extended                                                                                                |
| Integer        | Floating-point  | 4-16 clock-cycles<br>Signed → Floating-point is faster than<br>Unsigned → Floating-point (except AVX512<br>instruction set is enabled) |
| Floating-point | Integer         | fast if SSE2, slow otherwise (50-100 clock-cycles)                                                                                     |

---

# Floating-Point Division

## Multiplication is much faster than division\*

not optimized:

```
// "value" is floating-point (dynamic)
for (int i = 0; i < N; i++)
 A[i] = B[i] / value;
```

optimized:

```
div = 1.0 / value; // div is floating-point
for (int i = 0; i < N; i++)
 A[i] = B[i] * div;
```

---

\* Multiplying by the inverse is not the same as the division  
see [lemire.me/blog/2019/03/12](http://lemire.me/blog/2019/03/12)

# Floating-Point FMA

Modern processors allow performing `a * b + c` in a single operation, called **fused multiply-add** (`std::fma` in C++11). This implies better performance and accuracy

CPU processors perform computations with a larger register size than the original data type (e.g. 48-bit for 32-bit floating-point) for performing this operation

Compiler behavior:

- GCC 9 and ICC 19 produce a single instruction for `std::fma` and for `a * b + c` with `-O3 -march=native`
- Clang 9 and MSVC 19.\* produce a single instruction for `std::fma` but not for `a * b + c`

---

FMA: solve quadratic equation

FMA: extended precision addition and multiplication by constant

**Compiler intrinsics** are highly optimized functions directly provided by the compiler instead of external libraries

*Advantages:*

- Directly mapped to hardware functionalities if available
- Inline expansion
- Do not inhibit high-level optimizations, and they are portable contrary to `asm` code

*Drawbacks:*

- Portability is limited to a specific compiler
- Some intrinsics do not work on all platforms
- The same intrinsics can be mapped to a non-optimal instruction sequence depending on the compiler

Most compilers provide intrinsics **bit-manipulation functions** for SSE4.2 or ABM (Advanced Bit Manipulation) instruction sets for Intel and AMD processors

GCC examples:

`__builtin_popcount(x)` count the number of one bits

`__builtin_clz(x)` (count leading zeros) counts the number of zero bits following the most significant one bit

`__builtin_ctz(x)` (count trailing zeros) counts the number of zero bits preceding the least significant one bit

`__builtin_ffs(x)` (find first set) index of the least significant one bit

- Compute integer `log2`

```
inline unsigned log2(unsigned x) {
 return 31 - __builtin_clz(x);
}
```

- Check if a number is a power of 2

```
inline bool is_power2(unsigned x) {
 return __builtin_popcount(x) == 1;
}
```

- Bit search and clear

```
inline int bit_search_clear(unsigned x) {
 int pos = __builtin_ffs(x); // range [0, 31]
 x &= ~(1u << pos);
 return pos;
}
```

## Example of intrinsic portability issue:

`__builtin_popcount()` GCC produces `__popcountdi2` instruction while Intel Compiler (ICC) produces 13 instructions

`_mm_popcnt_u32` GCC and ICC produce `popcnt` instruction, but it is available only for processor with support for SSE4.2 instruction set

## More advanced usage

- Compute CRC: `_mm_crc32_u32`
- AES cryptography: `_mm256_aesenclast_epi128`
- Hash function: `_mm_sha256msg1_epu32`



*Using intrinsic instructions is extremely dangerous if the target processor does not natively support such instructions*

Example:

*“If you run code that uses the intrinsic on hardware that doesn’t support the `lzcnt` instruction, the results are unpredictable” - MSVC*

on the contrary, GNU and clang `__builtin_*` instructions are always well-defined. The instruction is translated to a non-optimal operation sequence in the worst case

The instruction set support should be checked at *run-time* (e.g. with `__cpuid` function on MSVC), or, when available, by using compiler-time macro (e.g. `__AVX__`)

# Automatic Compiler Function Transformation

`std::abs` can be recognized by the compiler and transformed to a hardware instruction

In a similar way, C++20 provides a portable and efficient way to express bit operations

`<bit>`

```
rotate left : std::rotr
rotate right : std::rotr
count leading zero : std::countl_zero
count leading one : std::countl_one
count trailing zero : std::countr_zero
count trailing one : std::countr_one
population count : std::popcount
```

## Value in a Range

Checking if a non-negative value  $x$  is within a range  $[A, B]$  can be optimized if  $B > A$  (useful when the condition is repeated multiple times)

```
if (x >= A && x <= B)

// STEP 1: subtract A
if (x - A >= A - A && x - A <= B - A)
// -->
if (x - A >= 0 && x - A <= B - A) // B - A is precomputed

// STEP 2
// - convert "x - A >= 0" --> (unsigned) (x - A)
// - "B - A" is always positive
if ((unsigned) (x - A) <= (unsigned) (B - A))
```

## Value in a Range Examples

Check if a value is an uppercase letter:

```
uint8_t x = ...
```

```
if (x >= 'A' && x <= 'Z')
```

```
...
```

→

```
uint8_t x = ...
```

```
if (x - 'A' <= 'Z')
```

```
...
```

A more general case:

```
int x = ...
```

```
if (x >= -10 && x <= 30)
```

```
...
```

→

```
int x = ...
```

```
if ((unsigned) (x + 10) <= 40)
```

```
...
```

---

The compiler applies this optimization only in some cases  
(tested with GCC/Clang 9 -O3)

# Lookup Table

**Lookup table (LUT)** is a *memoization* technique which allows replacing *runtime* computation with precomputed values

Example: a function that computes the logarithm base 10 of a number in the range [1-100]

```
template<int SIZE, typename Lambda>
constexpr std::array<float, SIZE> build(Lambda lambda) {
 std::array<float, SIZE> array{};
 for (int i = 0; i < SIZE; i++)
 array[i] = lambda(i);
 return array;
}

float log10(int value) {
 constexpr auto lambda = [](int i) { return std::log10f((float) i); };
 static constexpr auto table = build<100>(lambda);
 return table[value];
}
```

Collection of low-level implementations/optimization of common operations:

- **Bit Twiddling Hacks**

`graphics.stanford.edu/~seander/bithacks.html`

- **The Aggregate Magic Algorithms**

`aggregate.org/MAGIC`

- **Hackers Delight Book**

`www.hackersdelight.org`

The same instruction/operation may take different clock-cycles on different architectures/CPU type

- **Agner Fog - Instruction tables** (latencies, throughputs)  
`www.agner.org/optimize/instruction_tables.pdf`
- **Latency, Throughput, and Port Usage Information**  
`uops.info/table.html`

# Control Flow

---



**Computation is faster than decision**

**Pipelines** are an essential element in modern processors. Some processors have up to 20 pipeline stages (14/16 typically)

The downside to long pipelines includes the danger of **pipeline stalls** that waste CPU time, and the time it takes to reload the pipeline on **conditional branch** operations ( `if` , `while` , `for` )

- Prefer `switch` statements to multiple `if`
  - If the compiler does not use a jump-table, the cases are evaluated in order of appearance → the most frequent cases should be placed before
  - Some compilers (e.g. `clang`) are able to translate a sequence of `if` into a `switch`
- In general, a *branch* has negligible effect on performance if it is not taken
- Not all control flow instructions (or branches) are translated into `jump` instructions. If the code in the branch is small, the compiler could optimize it in a conditional instruction, e.g. `ccmovl`  
Small code section can be optimized in different ways <sup>2</sup> (see next slides)

---

Branch predictor: How many 'if's are too many?

<sup>2</sup> Is this a branch?

## Minimize Branch Overhead

- **Branch prediction:** technique to guess which way a branch takes. It requires hardware support, and it is generically based on dynamic history of code executing
- **Branch predication:** a conditional branch is substituted by a sequence of instructions from both paths of the branch. Only the instructions associated to a *predicate* (boolean value), that represents the direction of the branch, are actually executed

```
int x = (condition) ? A[i] : B[i];
P = (condition) // P: predicate
@P x = A[i];
@!P x = B[i];
```

- **Speculative execution:** execute both sides of the conditional branch to better utilize the computer resources and commit the results associated to the branch taken

## Branch Hints - `[[likely]]` / `[[unlikely]]`

C++20 `[[likely]]` and `[[unlikely]]` provide a hint to the compiler to optimize a conditional statement, such as `while`, `for`, `if`

```
for (i = 0; i < 300; i++) {
 [[unlikely]] if (rand() < 10)
 return false;
}
```

```
switch (value) {
 [[likely]] case 'A': return 2;
 [[unlikely]] case 'B': return 4;
}
```

## Signed/Unsigned Integers

- Prefer **signed integer** for **loop indexing**. The compiler optimizes more aggressively such loops because integer overflow is not defined. Unsigned loop indexing generates complex intermediate expressions, especially for nested loops, that the compiler could not solve
- Prefer **32-bit signed integer** or **64-bit integer** for **any operation that is translated to 64-bit**. The most common is *array indexing*. The subscript operator implicitly defines its parameter as `size_t`. Any indexing operation with 32-bit unsigned integer requires the compiler to enforce wrap-around behavior, e.g. by moving the variable to a 32-bit register

```
unsigned v = ...;
// some operations on v
array[v];
```

# Loops

- Prefer **square brackets** syntax `[]` over pointer arithmetic operations for array access to facilitate compiler loop optimizations (e.g. polyhedral loop transformations)
- *Range-based* loop could provide minor performance improvements for small loops that iterate over a container <sup>1</sup>
- On the other hand, *range-based loops* and *iterators* could inhibit many optimizations such as loop unrolling and vectorization

---

<sup>1</sup> The Little Things: Everyday efficiencies

# Loop Hoisting

**Loop Hoisting**, also called *loop-invariant code motion*, consists of moving statements or expressions outside the body of a loop *without affecting the semantics* of the program

Base case:

```
for (int i = 0; i < 100; i++)
 a[i] = x + y;
```

Better:

```
v = x + y;
for (int i = 0; i < 100; i++)
 a[i] = v;
```

Loop hoisting is also important in the evaluation of loop conditions

Base case:

```
// "x" never changes
for (int i = 0; i < f(x); i++)
 a[i] = y;
```

Better:

```
int limit = f(x);
for (int i = 0; i < limit; i++)
 a[i] = y;
```

In the worst case, `f(x)` is evaluated at every iteration (especially when it belongs to another translation unit)



**Loop unrolling** (or **unwinding**) is a loop transformation technique which optimizes the code by removing (or reducing) loop iterations

The optimization produces better code at the expense of binary size

Example:

```
for (int i = 0; i < N; i++)
 sum += A[i];
```

can be rewritten as:

```
for (int i = 0; i < N; i += 8) {
 sum += A[i];
 sum += A[i + 1];
 sum += A[i + 2];
 sum += A[i + 3];
 ...
} // we suppose N is a multiple of 8
```

## Loop unrolling can make your code better/faster:

- + Improve instruction-level parallelism (ILP)
- + Allow vector (SIMD) instructions
- + Reduce control instructions and branches

## Loop unrolling can make your code worse/slower:

- Increase compile-time/binary size
- Require more instruction decoding
- Use more memory and instruction cache

**Unroll directive** The Intel, IBM, Arm, Nvidia, clang, and GCC compilers provide the preprocessing directive `#pragma unroll` (`#pragma GCC unroll` for GCC) to insert above the loop to force loop unrolling. The compiler already applies the optimization in most cases

# Assertions

Some compilers (e.g. clang) use assertions for optimization purposes: most likely code path, not possible values, etc. <sup>3</sup>



Mehdi Amini  
@JokerEph

And 1h gone easily tracking why an assert build of a microbenchmark was 2x faster (!) than the release build...  
Not CPU scaling this time, not CPU assignment, it was -D\_GLIBCXX\_ASSERTIONS!  
Turns out that LLVM optimizer likes the added assertions and take advantage of these... 🤔

[Traduci post](#)

```
#include "benchmark/benchmark.h"

static void strCpy(benchmark::State& state) {
 std::string x = "hello";
 for (auto _ : state) {
 std::string copy(x);
 copy += " world";
 }
}

BENCHMARK(func: strCpy);
BENCHMARK_MAIN();
```



Mehdi Amini @JokerEph · 16 mar

Seems to me that a bunch of `__builtin_unreachable` and `__builtin_expect` that are part of `_GLIBCXX_ASSERTIONS` should be present in release mode.

Actually, they probably should be there **"only"** in release mode: these aren't assertions, but optimizers hints...



🇷🇺 Andrei Alexandrescu 🇷🇺 @incomputable · 6 apr 2020

Alrighty, so this makes my code 8% faster with g++. I am not kidding:

```
#ifdef NDEBUG
#undef assert
#define assert(c) if (c) {} else { __builtin_unreachable(); }
#endif
```

Why don't they define it like that to start with?

## Compiler Hints - `[[assume]]/std::unreachable()`

C++23 allows defining an *assumption* in the code that is always true

```
int x = ...;
[[assume(x > 0)]]; // the compiler assume that 'x' is positive

int y = x / 2; // the operation is translated in a single shift as for
 // the unsigned case
```

C++23 also provides `std::unreachable()` (`<utility>`) for marking unreachable code

Compilers provide non-portable instructions for previous C++ standards: `__builtin_assume()` (clang), `__builtin_unreachable()` (gcc), `__assume()` (msvc)

Note: sometimes user-provided information leads to worse optimization, see [@llvm.assume blocks optimization](#) and [Refined Input, Degraded Output: The Counterintuitive World of Compiler Behavior](#)

**Avoid run-time recursion** (very expensive). Prefer *iterative* algorithms instead

**Recursion cost:** The program must store all variables (snapshot) at each recursion iteration on the stack, and remove them when the control return to the caller instance

The **tail recursion** optimization avoids maintaining caller stack and pass the control to the next iteration. The optimization is possible only if all computation can be executed before the recursive call

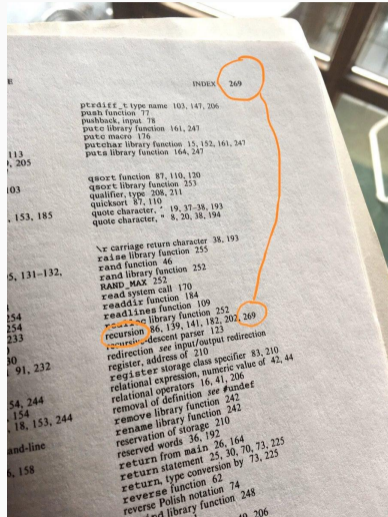
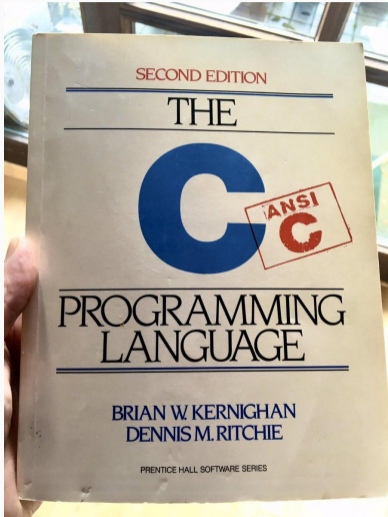

# Functions

---

# Function Call Cost

## Function call methods:

**Direct** Function address is known at compile-time

**Indirect** Function address is known only at run-time

**Inline** The function code is fused in the caller code (same translation unit or Link-time-optimization)

## Direct/Indirect function call cost:

- The caller pushes the arguments on the stack in reverse order
- Jump to function address
- The caller clears (pop) the stack
- The function pushes the return value on the stack
- Jump to the caller address



The **optimal way** to pass and return arguments (*by-value*) to/from functions is in *registers*. It also avoid the pointer aliasing performance issue. The following conditions must be satisfied:

- The object is **trivially copyable**: No user-provided copy/move/default constructors, destructor, and copy/move assignment operators, no virtual functions, apply recursively to base classes and non-static data members
- Linux/Unix (SystemV x86-64 ABI): data types  $\leq$  **16 bytes** ( $8B \times 2$ ), max **6 arguments**
- Windows (x64 ABI): data types  $\leq$  **8 bytes**, max **4 arguments**

- 
- when are structs/classes passed and returned in registers?
  - System V ABI - X86-64 Calling Convention
  - x64 calling convention - Parameter Passing

- If the previous conditions are not satisfied, the object is passed **by-reference**. In addition, objects that are not *trivially-copyable* could be expensive to pass *by-value* (copied).
- Pass **by-reference** and **by-pointer** introduce one level of indirection
- Pass **by-reference** is more efficient than pass **by-pointer** because it facilitates variable elimination by the compiler, and the function code does not require checking for `NULL` pointer

`const` modifier applied to values, pointers, references *does not produce better code* in most cases, but it is useful for ensuring read-only accesses

In some cases, pass `by-const` is beneficial for performance because `const` member function overloading could be cheaper than their counterparts

## inline

`inline` specifier for optimization purposes is just a hint for the compiler that increases the heuristic threshold for **inlining**, namely copying the function body where it is called

```
inline void f() { ... }
```

- the compiler can ignore the hint
- *inlined* functions increase the binary size because they are expanded in-place for every function call

## Compilers have different heuristics for function inlining

- Number of lines (even comments: How new-lines affect the Linux kernel performance)
- Number of assembly instructions
- Inlining depth (recursive)

GCC/Clang extensions allow to *force* inline/non-inline functions:

```
[[gnu::always_inline]] void f() { ... }
[[gnu::noinline]] void f() { ... }
[[msvc::forceinline]] void f() { ... }
```

- 
- An Inline Function is As Fast As a Macro
  - Inlining Decisions in Visual Studio

The compiler can *inline* a function only if it is independent from external references

- A function with *internal linkage* is not visible outside the current translation unit, so it can be aggressively *inlined*
- On the other hand, *external linkage* doesn't prevent function inlining if the function body is visible in a translation unit. In this situation, the compiler can duplicate the function code if it determines that there are no external references

All compilers, except MSVC, export all function symbols → the symbols can be used in other translation units and this can prevent inlining

Alternatives:

- Use `static` functions
- Use `anonymous namespace` (functions and classes)
- Use GNU extension (also clang) `__attribute__((visibility("hidden")))`

## Function Attributes

Some compilers, including Clang, GCC, provide additional attributes to optimize function calls:

- `__attribute__((pure))` / `[[gnu::pure]]` *no side effects* on its parameters and no external global references (program state)  
→ subject to data flow analysis and might be eliminated
- `__attribute__((const))` / `[[gnu::const]]` *depends only* on its parameters, no read from global references  
→ subject to common sub-expression elimination and loop optimizations

*note:* the compiler is able to deduce such properties in most cases

---

Implications of pure and constant functions

`__attribute__((pure))` function attribute



Consider the following example:

```
// suppose f() is not inline
void f(int* input, int size, int* output) {
 for (int i = 0; i < size; i++)
 output[i] = input[i];
}
```

- The compiler cannot *unroll* the loop (sequential execution, no ILP) because `output` and `input` pointers can be **aliased**, e.g. `output = input + 1`
- The aliasing problem is even worse for more complex code and *inhibits all kinds of optimization* including code re-ordering, vectorization, common sub-expression elimination, etc.

Most compilers (included GCC/Clang/MSVC) provide **restricted pointers** (`__restrict`) so that the programmer asserts that the pointers are not aliased

```
void f(int* __restrict input,
 int size,
 int* __restrict output) {
 for (int i = 0; i < size; i++)
 output[i] = input[i];
}
```

Potential benefits:

- Instruction-level parallelism
- Less instructions executed
- Merge common sub-expressions

## Benchmarking matrix multiplication

```
void matrix_mul_v1(const int* A,
 const int* B,
 int N,
 int* C) {
```

```
void matrix_mul_v2(const int* __restrict A,
 const int* __restrict B,
 int N,
 int* __restrict C) {
```

| Optimization | -O1      | -O2    | -O3    |
|--------------|----------|--------|--------|
| v1           | 1,030 ms | 777 ms | 777 ms |
| v2           | 513 ms   | 510 ms | 761 ms |
| Speedup      | 2.0x     | 1.5x   | 1.02x  |

```
void foo(std::vector<double>& v, const double& coeff) {
 for (auto& item : v) item *= std::sinh(coeff);
}
```

vs.

```
void foo(std::vector<double>& v, double coeff) {
 for (auto& item : v) item *= std::sinh(coeff);
}
```

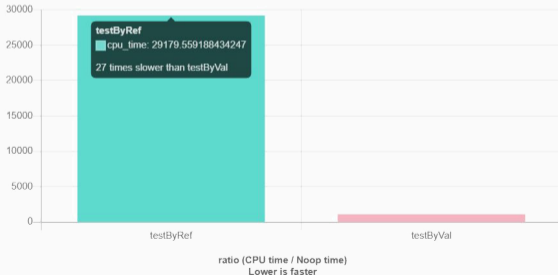

# Object-Oriented Programming

---

# Variable/Object Scope

## Declare local variable in the innermost scope

- the compiler can more likely fit them into registers instead of stack
- it improves readability

### Wrong:

```
int i, x;
for (i = 0; i < N; i++) {
 x = value * 5;
 sum += x;
}
```

### Correct:

```
for (int i = 0; i < N; i++) {
 int x = value * 5;
 sum += x;
}
```

- C++17 allows local variable initialization in `if` and `while` statements, while C++20 introduces them for in *range-based loops*

## Variable/Object Scope

**Exception!** Built-in type variables and passive structures should be placed in the innermost loop, while objects with constructors should be placed outside loops

```
for (int i = 0; i < N; i++) {
 std::string str("prefix_");
 std::cout << str + value[i];
} // str call CTOR/DTOR N times
```

```
std::string str("prefix_");
for (int i = 0; i < N; i++) {
 std::cout << str + value[i];
}
```

# Object Optimizations

- Prefer **direct initialization** and *full object constructor* instead of two-step initialization (also for variables)
- Prefer **move semantic** instead of *copy constructor*. Mark *copy constructor* as `=delete` (sometimes it is hard to see, e.g. implicit)
- Use `static` for all members that do not use instance member (avoid passing `this` pointer)
- If the object semantic is *trivially copyable*, ensure **defaulted** `= default` *default/copy constructors* and *assignment operators* to enable vectorization



# Object Dynamic Behavior Optimizations

- **Virtual calls** are slower than standard functions
  - Virtual calls prevent any kind of optimizations as function lookup is at runtime (loop transformation, vectorization, etc.)
  - Virtual call overhead is up to 20%-50% for function that can be inlined
- Mark `final` all `virtual` functions that are not overridden
- Avoid dynamic operations, e.g. `dynamic_cast`

- 
- The Hidden Performance Price of Virtual Functions
  - Investigating the Performance Overhead of C++ Exceptions

# Object Operation Optimizations

- Minimize multiple `+` operations between objects to avoid temporary storage
- Prefer `x += obj`, instead of `x = x + obj` → avoid object copy and temporary storage
- Prefer `++obj` / `--obj` (return `&obj`), instead of `obj++`, `obj--` (copy and return old `obj`)

# Object Implicit Conversion

```
struct A { // big object
 int array[10000];
};
struct B {
 int array[10000];

 B() = default;

 B(const A& a) { // user-defined constructor
 std::copy(a.array, a.array + 10000, array);
 }
};
//-----
void f(const B& b) {}

A a;
B b;
f(b); // no cost
f(a); // very costly!! implicit conversion
```

# Std Library and Other Language Aspects

---

- Avoid old C library routines such as `qsort`, `bsearch`, etc. Prefer `std::sort`, `std::binary_search` instead
  - `std::sort` is based on a hybrid sorting algorithm. Quick-sort / head-sort (introsort), merge-sort / insertion, etc. depending on the std implementation
  - Prefer `std::find()` for small array, `std::lower_bound`, `std::upper_bound`, `std::binary_search` for large sorted array

# Function Optimizations

- `std::fill` applies `memset` and `std::copy` applies `memcpy` if the input/output are continuous in memory
- Use the same type for initialization in functions like `std::accumulate()`, `std::fill`

```
auto array = new int[size];
...
auto sum = std::accumulate(array, array + size, 0u);
// 0u != 0 → conversion at each step

std::fill(array, array + size, 0u);
// it is not translated into memset
```

# Containers

- Use `std` container member functions (e.g. `obj.find()`) instead of external ones (e.g. `std::find()`). Example: `std::set`  $O(\log(n))$  vs.  $O(n)$
- Be aware of container properties, e.g. `vector.push_vector(v)`, instead of `vector.insert(vector.begin(), value)` → entire copy of all vector elements
- Set `std::vector` size during the object construction (or use the `reserve()` method) if the number of elements to insert is known in advance → every implicit resize is equivalent to a copy of all vector elements
- Consider *unordered* containers instead of the standard one, e.g. `unordered_map` vs. `map`
- Prefer `std::array` instead of dynamic heap allocation

## Critics to Standard Template Library (STL)

- Platform/Compiler-dependent implementation
- Execution order and results across platforms
- Debugging is hard
- Complex interaction with custom memory allocators
- Error handling based on exceptions is non-transparent
- Binary bloat
- Compile time (see C++ Compile Health Watchdog, and STL Explorer)



## Other Language Aspects

- Prefer `lambda` expression (or `function object`) instead of `std::function` or function pointers
- Avoid dynamic operations: **exceptions** (and use `noexcept`), **smart pointer** (e.g. `std::unique_ptr`)
- Use `noexcept` decorator → program is aborted if an error occurred instead of raising an exception. see  
Bitcoin: 9% less memory: `make SaltedOutpointHasher noexcept`

# Modern C++ Programming

## 23. PERFORMANCE OPTIMIZATION III NON-CODING OPTIMIZATIONS AND BENCHMARKING

---

*Federico Busato*

2024-11-05

## **1** Compiler Optimizations

- About the Compiler
- Compiler Optimization Flags
- Floating-point Optimization Flags
- Linker Optimization Flags
- Architecture Flags
- Help the Compiler to Produce Better Code
- Profile Guided Optimization (PGO)
- Post-Processing Binary Optimizer
- Polyhedral Optimizations

## **2** Compiler Transformation Techniques

- Basic Compiler Transformations
- Loop Unswitching
- Loop Fusion
- Loop Fission
- Loop Interchange
- Loop Tiling

## **3** Libraries and Data Structures

## 4 Performance Benchmarking

- What to Test?
- Workload/Dataset Quality
- Cache Behavior
- Stable CPU Performance
- Multi-Threads Considerations
- Program Memory Layout
- Measurement Overhead
- Compiler Optimizations
- Metric Evaluation

## 5 Profiling

- gprof
- uftrace
- callgrind
- cachegrind
- perf Linux profiler

## **6** Parallel Computing

- Concurrency vs. Parallelism
- Performance Scaling
- Gustafson's Law
- Parallel Programming Languages

# Compiler Optimizations

---



*"I always say the purpose of optimizing compilers is not to make code run faster, but to prevent programmers from writing utter \*\*\*\* in the pursuit of making it run faster"*

**Rich Felker**, *musl-libc* (*libc* alternative)

```
bool isEven(int number) {
 int numberCompare = 0;
 bool even = true;
 while (number != numberCompare) {
 even = !even;
 numberCompare++;
 }
 return even;
}
```



```
bool isEven(int number) {
 return number & 1u;
}
```

On the other hand, having a good compiler does not mean that it can fully optimize any code:

- The compiler does not “*understand*” the code, as opposed to human
- The compiler is *conservative* and applies optimizations only if they are safe and do not affect the correctness of computation
- The compiler is full of *models and heuristics* that could not match a specific situation
- The compiler *cannot spend large amount of time* in code optimization
- The compiler could consider *other targets* outside performance, e.g. binary size

*Important advise:* **Use an updated version of the compiler**

- Newer compiler produces **better/faster code**
  - Effective optimizations
  - Support for newer CPU architectures
- **New warnings** to avoid common errors and better support for existing error/warnings (e.g. code highlights)
- **Faster compiling, less memory usage**
- **Less compiler bugs:** compilers are very complex and they have many bugs

*Use an updated version of the linker:* e.g. for *Link Time Optimization*,  
gold linker or LLVM linker `lld`

## Which compiler?

**Answer:** It depends on the code and on the processor

example: GCC 9 vs. Clang 8

Some compilers can produce optimized code for specific architectures:

- **Intel Compiler** (commercial): Intel processors
- **IBM XL Compiler** (commercial): IBM processors/system
- **Nvidia NVC++ Compiler** (free/commercial): Multi-core processors/GPUs

- 
- [gcc.gnu.org/onlinedocs/gcc/Optimize-Options.html](http://gcc.gnu.org/onlinedocs/gcc/Optimize-Options.html)
  - Intel Blog: [gcc-x86-performance-hints](#)
  - [Advanced Optimization and New Capabilities of GCC 10](#)

`-O0` , `/O0` Disables any optimization

- default behavior
- fast compile time

`-O1` , `/O1` Enables basic optimizations

`-O2` , `/O2` Enables advanced optimizations

- some optimization steps are expensive
- can increase the binary size

`-O3` Enable aggressive optimizations. Turns on all optimizations specified by `-O2` , plus some more

- `-O3` does not guarantee to produce faster code than `-O2`
- it could break floating-point IEEE754 rules in some non-traditional compilers (`nvc++`, `IBM xlc`)

`-O4` / `-O5` It is an alias of `-O3` in some compilers, or it can refer to `-O3` + inter-procedural optimizations (basic, full) and high-order transformation (HOT) optimizer for specialized loop transformations

`-Ofast` Provides other aggressive optimizations that may violate strict compliance with language standards. It includes `-O3 -ffast-math`

`-Os` , `/Os` Optimize for size. It enables all `-O2` optimizations that do not typically increase code size (e.g. loop unrolling)

`-Oz` Aggressively optimize for size

`-funroll-loops` Enables loop unrolling (not included in `-O3` )

`-fprefetch-loop-arrays` Emit prefetch instructions in loops (not included in `-O3` )

`-fopt-info` Describes optimization passes and missed optimizations

`-fopt-info-missed`



In general, enabling the following flags implies less floating-point accuracy, breaking the IEEE754 standard, and it is implementation dependent (not included in `-O3` )

`-fno-signaling-nans`

`-fno-trapping-math` Disable floating-point exceptions

`-mfma -ffp-contract=fast` Force floating-point expression contraction such as forming of fused multiply-add operations

`-ffinite-math-only` Disable special conditions for handling `inf` and `NaN`

`-fassociative-math` Assume floating-point associative behavior

`-funsafe-math-optimizations` Allows breaking floating-point associativity and enables reciprocal optimization

`-ffast-math` Enables aggressive floating-point optimizations. All the previous, flush-to-zero denormal number, plus others

---

Beware of fast-math

Semantics of Floating Point Math in GCC

# Linker Optimization Flags

`-flto` Enables *Link Time Optimizations* (Interprocedural Optimization). The linker merges all modules into a single combined module for optimization

- the linker must support this feature: GNU `ld v2.21++` or gold version, to check with `ld --version`
- it can significantly improve the performance
- in general, it is a very expensive step, even longer than the object compilations

`-fwhole-program` Assume that the current compilation unit represents the whole program being compiled → Assume that all non-extern functions and variables belong only to their compilation unit

Architecture-oriented optimizations are not included in other flags ( `-O3` )

`-m64` In 64-bit mode the number of available registers increases from 6 to 14 general and from 8 to 16 XMM. Also, all 64-bits x86 architectures have SSE2 extension by default. 64-bit applications can use more than 4GB address space

`-m32` 32-bit mode. It should be combined with `-mfpmath=sse` to enable using of XMM registers in floating point instructions (instead of stack in x87 mode). 32-bit applications can use less than 4GB address space

It is recommended to use 64-bits for High-Performance Computing applications and 32-bits for phone and tablets applications

`-march=<arch>` Generates instructions for a specific processor to exploit exclusive hardware features. `<arch>` represents the minimum hardware supported by the binaries (not portable)

`-mtune=<tune_arch>` Specifies the target microarchitecture. Generates optimized code for a class of processors without exploiting specific hardware features. Binaries are still compatibles with other processors, e.g. earlier CPUs in the architecture family (maybe slower than `-march`)

`-mcpu=<tune_arch>` Deprecated synonym for `-mtune` for x86-64 processors, optimizes for both a particular architecture and microarchitecture on Arm

`-mfpu<fp_hw>` (Arm) Optimize for a specific floating-point hardware

`-m<instr_set>` (x86-64) Optimize for a specific instruction set

```
<arch> armv9-a , armv7-a+neon-vfpv4 , znver4 , core2 , skylake
<tune_arch> cortex-a9 , neoverse-n2 , generic , intel
<instr_set> see2 , avx512
<fp_hw> neon , neon-fp-armv8
```

- `<tune_arch>` should be always greater than `<arch>`
- In general, `-mtune` is set to `generic` if not specified
- `-march=native` , `-mtune=native` , `-mcpu=native` : Allows the compiler to determine the processor type (not always accurate)
- Especially with new compilers, prefer **auto-vectorization** to explicit vector intrinsics

---

- GCC Arm options, GCC X86-64 options

- Compiler flags across architectures: `-march`, `-mtune`, and `-mcpu`

- NVIDIA Grace CPU Benchmarking Guide, Arm Vector Instructions: SVE and NEON

GCC and Clang provide the attributes `target` and `target_clones` to automatically generate different instruction set backends that are dispatched at runtime

- `target` accepts different target options than specified on the command line. The original target command-line options are ignored
- `target_clones` accepts different targets in addition to the options specified on the command line

```
__attribute__((__target__("sse4.1,arch=core2")))
void f1() {}

__attribute__((__target_clones__("sse4.1,avx,default")))
void f2() {}
```

## Help the Compiler to Produce Better Code

- Grouping variables and functions related to each other in the same translation unit
- Define *global variables* and *functions* in the translation unit in which they are used more often
- *Global variables* and functions that are not used by other translation units should have *internal linkage* (*anonymous namespace*/ `static` function)

**Static library linking helps the linker to optimize the code across different modules (link-time optimizations).** Dynamic linking prevents these kinds of optimizations



**Profile Guided Optimization (PGO)** is a compiler technique aims at improving the application performance by reducing instruction-cache problems, reducing branch mispredictions, etc. *PGO provides information to the compiler about areas of an application that are most frequently executed*

It consists in the following steps:

- (1) Compile and *instrument* the code
- (2) *Run* the program by exercising the most used/critical paths
- (3) *Compile again* the code and exploit the information produced in the previous step

The particular options to instrument and compile the code are compiler specific

## GCC

```
$ gcc -fprofile-generate my_prog.c my_prog # program instrumentation
$./my_prog # run the program (most critical/common path)
$ gcc -fprofile-use -O3 my_prog.c my_prog # use instrumentation info
```

## Clang

```
$ clang++ -fprofile-instr-generate my_prog.c my_prog
$./my_prog
$ xcrun llvm-profdata merge -output default.profdata default.profraw
$ clang++ -fprofile-instr-use=default.profdata -O3 my_prog.c my_prog
```

# PGO, LTO Performance

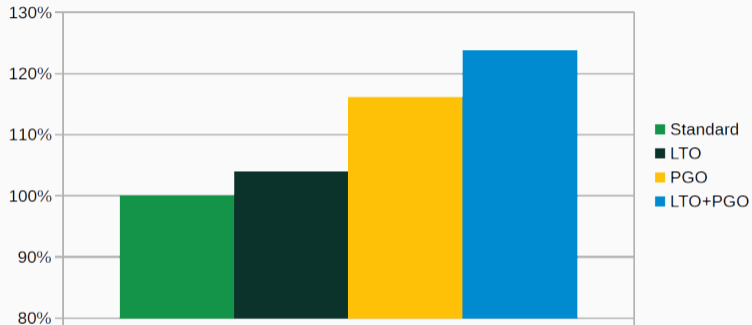

SPEC 2017 built with GCC 10.2 and -O2

The code layout in the final binary can be further optimized with a **post-link binary optimizer** and **layout optimization** like BOLT or Propeller (sampling or instrumentation profile)

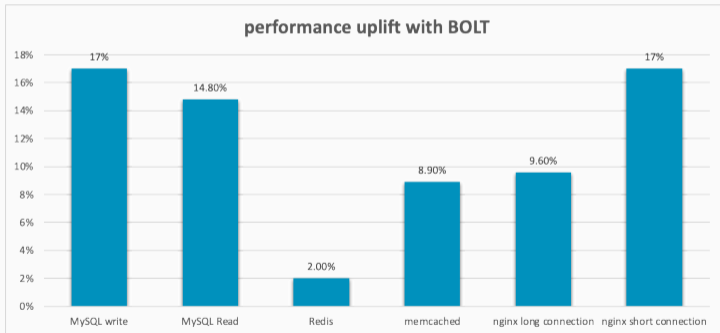

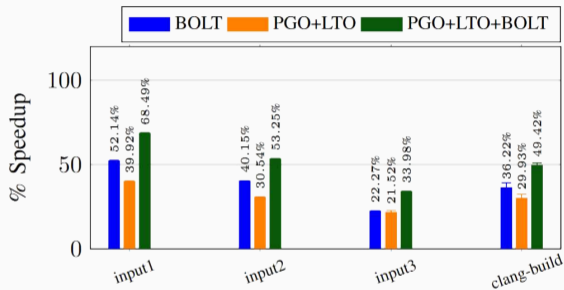

Cumulative speedup over bootstrapped build, Building Clang

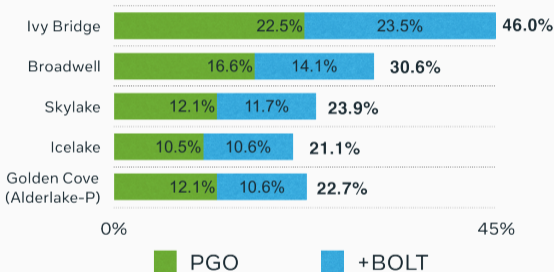

2022 LLVM Dev Meeting: Optimizing Clang with BOLT using CMake

The many faces of LLVM PGO and FDO

BOLT optimization technology could bring obvious performance uplift on arm server

**Polyhedral optimization** is a compilation technique that rely on the representation of programs, especially those involving nested loops and arrays, in *parametric polyhedra*. Thanks to combinatorial and geometrical optimizations on these objects, the compiler is able to analyze and optimize the programs including *automatic parallelization*, *data locality*, *memory management*, *SIMD instructions*, and *code generation for hardware accelerators*

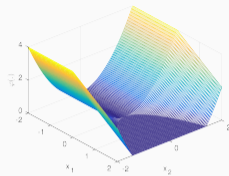

Polly [↗](#) is a high-level loop and data-locality optimizer and optimization infrastructure for LLVM

PLUTO [↗](#) is an automatic parallelization tool based on the polyhedral model

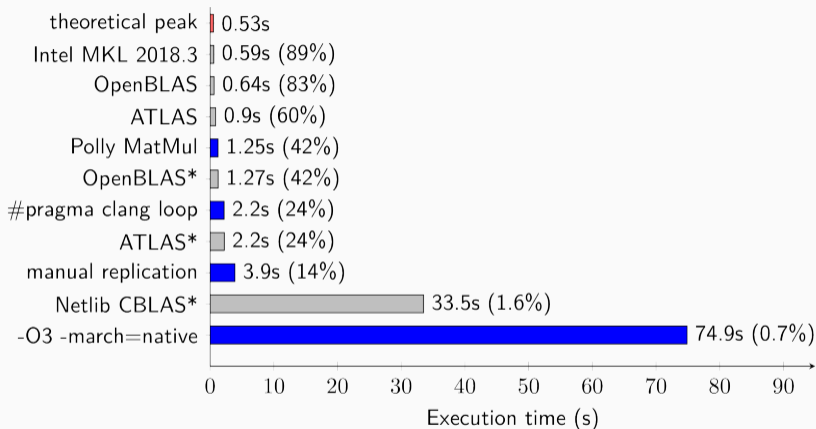

\* Pre-compiled from Ubuntu repository

# Compiler Transformation Techniques

---



## Overview on compiler code generation and transformation:

- Optimizations in C++ Compilers  
*Matt Godbolt, ACM Queue*
- Compiler Optimizations

- **Constant folding.** Direct evaluation constant expressions at compile-time

```
const int K = 100 * 1234 / 2;
```

- **Constant propagation.** Substituting the values of known constants in expressions at compile-time

```
const int K = 100 * 1234 / 2;
const int J = K * 25;
```

- **Common subexpression elimination.** Avoid computing identical and redundant expressions

```
int x = y * z + v;
int y = y * z + k; // y * z is redundant
```

- **Induction variable elimination.** Eliminate variables whose values are dependent (induction)

```
for (int i = 0; i < 10; i++)
 x = i * 8;
// "x" can be derived by knowing the value of "i"
```

- **Dead code elimination.** Elimination of code which is executed but whose result is never used, e.g. dead store

```
int a = b * c;
... // "a" is never used, "b * c" is not computed
```

*Unreachable code elimination* instead involves removing code that is never executed

- **Use-define chain.** Avoid computations related to a variable that happen before its definition

```
x = i * k + 1;
x = 32; // "i * k + 1" is not needed
```

- **Peephole optimization.** Replace a small set of low-level instructions with a faster sequence of instructions with better performance and the same semantic. The optimization can involve pattern matching

```
imul eax, eax, 8 // a * 8
sal eax, 3 // a << 3 (shift)
```

## Loop Unswitching

- **Loop Unswitching.** Split the loop to improve data locality, reduce loop instructions (especially branches), and allow additional optimizations

```
for (i = 0; i < N; i++) {
 if (x)
 a[i] = 0;
 else
 b[i] = 0;
}
```

```
if (x) {
 for (i = 0; i < N; i++)
 a[i] = 0; // use memset
}
else {
 for (i = 0; i < N; i++)
 b[i] = 0; // use memset
}
```

# Loop Fusion

- **Loop Fusion** (jamming). Merge multiple loops to improve data locality and perform additional optimizations

```
for (i = 0; i < 300; i++)
 a[i] = a[i] + sqrt(i);
for (i = 0; i < 300; i++)
 b[i] = b[i] + sqrt(i);
```

```
for (i = 0; i < 300; i++) {
 a[i] = a[i] + sqrt(i); // sqrt(i) is computed only
 b[i] = b[i] + sqrt(i); // one time
}
```

- **Loop Fission** (distribution). Split a loop in multiple loops to

```
for (i = 0; i < size; i++) {
 a[i] = b[rand()]; // cache pollution
 c[i] = d[rand()];
}
```

```
for (i = 0; i < size; i++)
 a[i] = b[rand()]; // better cache utilization
for (i = 0; i < size; i++)
 c[i] = d[rand()];
```

# Loop Interchange

- **Loop Interchange.** Exchange the order of loop iterations to improve data locality and perform additional optimizations (e.g. vectorization)

```
for (i = 0; i < 1000000; i++) {
 for (j = 0; j < 100; j++)
 a[j * x + i] = ...; // low locality
}
```

```
for (j = 0; j < 100; j++) {
 for (i = 0; i < 1000000; i++)
 a[j * x + i] = ...; // high locality
}
```



- **Loop Tiling** (blocking, nest optimization). Partition the iterations of multiple loops to exploit data locality

```
for (i = 0; i < N; i++) {
 for (j = 0; j < M; j++)
 a[j * N + i] = ...; // low locality
}
```

```
for (i = 0; i < N; i += TILE_SIZE) {
 for (j = 0; j < M; j += TILE_SIZE) {
 for (k = 0; k < TILE_SIZE; k++) {
 for (l = 0; l < TILE_SIZE; l++) {
```

# **Libraries and Data Structures**

---

Consider using optimized *external* libraries for critical program operations

**Compressed Bitmask:** set algebraic operations

- BitMagic Library [↗](#)
- Roaring Bitmaps [↗](#)

**Ordered Map/Set:** B+Tree as replacement for red-black tree

- STX B+Tree [↗](#)
- Abseil B-Tree [↗](#)

**Hash Table:** (replace for `std::unordered_set/map`)

- [Google Sparse/Dense Hash Table](#)
- [bytell hashmap](#)
- [Facebook F14 memory efficient hash table](#)
- [Abseil Hashmap](#) (2x-3x faster)
- [Robin Hood Hashing](#)
- [Comprehensive C++ Hashmap Benchmarks 2022](#)
- [An Extensive Benchmark of C and C++ Hash Tables](#)

- **Probabilistic Set Query:** Bloom filter, 'XOR filter [↗](#), Facebook's Ribbon Filter [↗](#), Binary Fuse filter [↗](#)
- **Scan, print, and formatting:** `fmt` library [↗](#), `scn` library [↗](#) instead of `iostream` or `printf/scanf`
- **Random generator:** `PCG` [↗](#)/`Xoshiro` [↗](#) random generators instead of Mersenne Twister or Linear Congruent
- **Integer hash function** instead of a random generator if the period length is not a concern `hash-prospector` [↗](#)
- **Non-cryptographic hash algorithm:** `xxHash` [↗](#) instead of CRC
- **Cryptographic hash algorithm:** `BLAKE3` [↗](#) instead of MD5 or SHA

- **Search:** Performance comparison: linear search vs binary search [↗](#)
- **Linear Algebra:** Eigen [↗](#), Armadillo [↗](#), Blaze [↗](#)
- **Sort:**
  - Beating Up on Qsort [↗](#). Radix-sort for non-comparative elements (e.g. `int`, `float`)
  - Vectorized and performance-portable Quicksort [↗](#)
- **malloc replacement:**
  - `tcmalloc` [↗](#) (Google)
  - `mimalloc` [↗](#) (Microsoft)

## Libraries and Std replacements

- **Folly**: Performance-oriented std library (Facebook)
- **Abseil**: Open source collection of C++ libraries drawn from the most fundamental pieces of Google's internal codebase
- **Frozen**: Zero-cost initialization for immutable containers, fixed-size containers, and various algorithms.



A curated list of awesome header-only  
C++ libraries

# Performance Benchmarking

---



*Performance benchmarking is a non-functional test focused on measuring the efficiency of a given task or program under a particular load*

## **Performance benchmarking is hard!!**

*Main reasons:*

- What to test?
- Workload/Dataset quality
- Cache behavior
- Stable CPU performance
- Program memory layout
- Measurement overhead
- Compiler optimizations
- Metric evaluation

# What to Test?

1. **Identify performance metrics:** The metric(s) should be strongly related to the specific problem and that allows a comparison across different systems, e.g. elapsed time is not a good metric in general for measuring the throughput
  - Matrix multiplication: Floating-point Operation Per Second (FLOP/S)
  - Graph traversing: Edge per Second (EPS)
2. **Plan performance tests:** Determine what part of the problem is relevant for solving the given problem, e.g. excluding initialization process
  - Suppose a routine that requires different steps and ask a memory buffer for each of them. Memory allocations should be excluded as a user could use a memory pool

## Workload/Dataset Quality

1. **Stress the most important cases:** Rare or edge cases that are not used in real-world applications or far from common usage are less important, e.g. a graph problem where all vertices are not connected
2. **Use datasets that are well-known in the literature and reproducible.** Don't use "self-made" dataset and, if possible, use public available resources
3. **Use a reproducible test methodology.** Trying to remove sources of "noise", e.g. if the procedure is randomized, the test should be use with the same seed. It is not always possible, e.g. OS scheduler, atomic operations in parallel computing, etc.

- *Cache behavior is not deterministic.* Different executions lead to different hit rates
- After a data is loaded from the main memory, it remains in the cache until it expires or is evicted to make room for new content
- Executing the same routine multiple times, the first run is much slower than the other ones due to the cache effect (warmup run)

*There is no a systematic way to flush the cache.* Some techniques to ensure more reliable performance results are

- overwrite all data involved in the computation between each runs
- read/write between two buffers of size at least the size of the largest cache
- some processors, such as ARM, provide specific instructions to *invalidate* the cache `__builtin___clear_cache()` , `__clear_cache()`

*Note:* manual cache invalidation must consider cache locality (e.g. L1 per CPU core) and compiler optimizations that can remove useless code (solution: use global variables and `volatile` )

One of the first source of fluctuation in performance measurement is due to unstable CPU frequency

**Dynamic frequency scaling**, also known as *CPU throttling*, automatically decreases the CPU frequency for:

- Power saving, extending battery life
- Decrease fan noise and chip heat
- Prevent high frequency damage

Modern processors also comprise advanced technologies to automatically **raise CPU operating frequency when demanding tasks are running** (e.g. Intel® Turbo Boost). Such technologies allow processors to run with the *highest possible frequency* for limited amount of time depending on different factors like *type of workload, number of active cores, power consumption, temperature, etc.*

Get CPU info:

- *CPU characteristics:*

```
lscpu
```

- *Monitor CPU clocks in real-time:*

```
cpupower monitor -m Mperf
```

- *Get CPU clocks info:*

```
cpupower frequency-info
```

see “cpufreq governors”

- *Disable Turbo Boost*

```
echo 1 >> /sys/devices/system/cpu/intel_pstate/no_turbo
```

- *Disable hyper threading*

```
echo 0 > /sys/devices/system/cpu/cpuX/online
```

or through BIOS

- Use “performance” *scaling governor* and max frequency and use ‘userspace’ governor to specify a fixed frequency

```
sudo cpupower frequency-set -g performance or
```

```
sudo cpufreq-set -f <frequency> , e.g. 3200000 (3.2 GHz)
```



- Use *'userspace'* governor to specify a fixed frequency

```
sudo cpufreq-set -g userspace
```

```
sudo cpufreq-set -u <frequency> , e.g. 3200000 (3.2 GHz)
```

- Set CPU affinity (CPU-Program binding) `taskset -c <cpu_id> <program>`

- Set process priority `sudo nice -n -5 taskset -c <cpu_id> <process>`

- *Disable address space randomization*

```
echo 0 | sudo tee /proc/sys/kernel/randomize_va_space
```

- *Drop file system cache* (if the benchmark involves IO ops)

```
echo 3 | sudo tee /proc/sys/vm/drop_caches; sync
```

- *CPU isolation*

don't schedule process and don't run kernels code on the selected CPUs. GRUB options: `isolcpus=<cpu_ids>,rcu_nocbs=<cpu_ids>`

- 
- How to get consistent results when benchmarking on Linux?
  - How to run stable benchmarks
  - Best Practices When Benchmarking CUDA Applications

## Multi-Threads Considerations

- `numactl --interleave=all`

NUMA: Non-Uniform Memory Access (e.g. multi-socket system)

The default behavior is to allocate memory in the same node as a thread is scheduled to run on, and this works well for small amounts of memory. However, when you want to allocate more than a single node memory, it is no longer possible. This option sets interleaved memory allocations among NUMA nodes

- `export OMP_NUM_THREADS=96` Set the number of threads in an OpenMP program

# Program Memory Layout

A small code change modifies the memory program layout

→ large impact on cache (up to 40%)

- **Linking**

- link order → changes function addresses
- upgrade a library

- **Environment Variable Size:** moves the program stack

- run in a new directory
- change username

---

- Performance Matters, *E. Berger*, CppCon20

- Producing Wrong Data Without Doing Anything Obviously Wrong!, *Mytkowicz et al.*, ASPLOS'09

**Time-measuring functions could introduce significant overhead for small computation**

```
std::chrono::high_resolution_clock::now() /
```

```
std::chrono::system_clock::now()
```

 rely on library/OS-provided functions to retrieve timestamps (e.g. `clock_gettime`) and their execution can take several clock cycles

Consider using a **benchmarking framework**, such as Google Benchmark or nanobench (`std::chrono` based), to retrieve hardware counters and get basic profiling info

## Compiler optimizations could distort the actual benchmark

- *Dead code elimination*: the compiler discards code that does not perform “useful” computation
- *Constant propagation/Loop optimization*: the compiler is able to pre-compute the result of simple codes
- *Instruction order*: the compiler can even move the time-measuring functions

## Other Considerations

**The actual values for a benchmark could significantly affect the results.** For instance, a GEMM operation could show 2X performance between matrices filled with zeros and random values due to the effect on power consumption

After extracting and collecting performance results, it is fundamental to report/summarize them in a way to fully understand the experiment, provide interpretable insights, ensure reliability, and compare different observations, e.g. codes, algorithms, systems, etc.



| Metric                   | Formula                                               | Description                                                                                                  |
|--------------------------|-------------------------------------------------------|--------------------------------------------------------------------------------------------------------------|
| Arithmetic mean          | $\bar{x} = \sum_{i=1}^n x_i$                          | For summarizing costs, e.g. exec. times, floating point ops, etc.                                            |
| Harmonic mean            | $\frac{n}{\sum_{i=1}^n \frac{1}{x_i}}$                | For summarizing rates, e.g. flop/s                                                                           |
| Geometric mean           | $\sqrt[n]{\prod_{i=1}^n x_i}$                         | For summarizing rates. Harmonic mean should be preferred.<br>Commonly used for comparing speedup             |
| Standard deviation       | $\sigma = \frac{\sum_{i=1}^n (x_i - \bar{x})^2}{n-1}$ | Measure of the spread of normally distributed samples                                                        |
| Coefficient of Variation | $\frac{std.dev}{arith.mean}$                          | Represents the stability of a set of normally distributed measurement results. Normalized standard deviation |

| Metric                                   | Formula                                                                                                                                     | Description                                                                                                                                                                    |
|------------------------------------------|---------------------------------------------------------------------------------------------------------------------------------------------|--------------------------------------------------------------------------------------------------------------------------------------------------------------------------------|
| <b>Confidence intervals of the mean</b>  | $z = t \left( n - 1, \frac{\alpha}{2} \right)$ $CI = \left[ \bar{x} - \frac{z\sigma}{\sqrt{n}}, \bar{x} + \frac{z\sigma}{\sqrt{n}} \right]$ | Measure of reliability of the experiment. The concept is interpreted as the probability (e.g. $\alpha = 95\%$ ) that the observed confidential interval contains the true mean |
| <b>Median</b>                            | value at position $n/2$ after sorting all data                                                                                              | Rank measures are more robust with regard to outliers but do not consider all measured values                                                                                  |
| <b>Quantile:<br/>Percentile/Quartile</b> | value at a given position after sorting all data                                                                                            | The percentiles/quartiles provide information about the spread of the data and the skew. It indicates the value below which a given percentage of data falls                   |
| <b>Minumum/<br/>Maximum</b>              | $\min / \max_{i=1}^n (x_i)$                                                                                                                 | Provide the lower/upper bounds of the data, namely the range of the values                                                                                                     |

| Confidence Interval | Z     |
|---------------------|-------|
| 80%                 | 1.282 |
| 85%                 | 1.440 |
| 90%                 | 1.645 |
| 95%                 | 1.960 |
| 99%                 | 2.576 |
| 99.5%               | 2.807 |
| 99.9%               | 3.291 |

Some metrics assume a normal distribution → the arithmetic mean, median and mode are all equal

$$\frac{|\bar{x} - median|}{\max(\bar{x}, median)}$$

If the *relative difference between the mean and median* is larger than 1%, values are probably not normally distributed

**Minimum/Maximum vs. Arithmetic mean.** The minimum/maximum could be used to get the best outcome of an experiment, namely the measure with the least noise. On the other hand, the arithmetic mean considers all values and could better represent the behavior of the experiment.

If the *skewness* of the distribution is *symmetrical* (e.g. normal, binomial) then the arithmetic mean is a superior statistic, while the minimum/maximum could be useful in the opposite case (e.g. log-normal distribution)

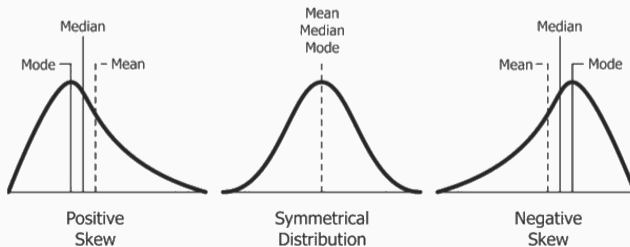

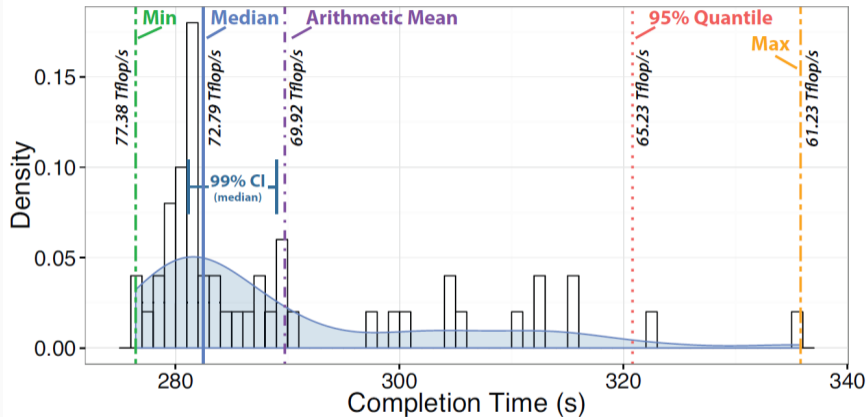

- Benchmarking: minimum vs average
- Scientific Benchmarking of Parallel Computing Systems
- Benchmarking C++ Code

# Profiling

---

A **code profiler** is a form of *dynamic program analysis* which aims at investigating the program behavior to find performance bottleneck. A profiler is crucial in saving time and effort during the development and optimization process of an application

Code profilers are generally based on the following methodologies:

- **Instrumentation** Instrumenting profilers insert special code at the beginning and end of each routine to record when the routine starts and when it exits. With this information, the profiler aims to measure the actual time taken by the routine on each call.

Problem: The timer calls take some time themselves

- **Sampling** The operating system interrupts the CPU at regular intervals (time slices) to execute process switches. At that point, a sampling profiler will record the currently-executed instruction

`gprof` is a profiling program which collects and arranges timing statistics on a given program. It uses a hybrid of instrumentation and sampling programs to monitor *function calls*

Website: [sourceware.org/binutils/docs/gprof/](http://sourceware.org/binutils/docs/gprof/)

## Usage:

- Code Instrumentation

```
$ g++ -pg [flags] <source_files>
```

Important: `-pg` is required also for linking and it is not supported by `clang`

- Run the program (it produces the file `gmon.out`)
- Run `gprof` on `gmon.out`

```
$ gprof <executable> gmon.out
```

- Inspect `gprof` output



## gprof output

```
Flat profile:
```

```
Each sample counts as 0.01 seconds.
```

| %<br>time | cumulative<br>seconds | self<br>seconds | calls | self<br>ms/call | total<br>ms/call | name             |
|-----------|-----------------------|-----------------|-------|-----------------|------------------|------------------|
| 84.04     | 0.85                  | 0.85            | 1     | 848.84          | 848.84           | yet_another_test |
| 6.00      | 0.91                  | 0.06            | 1     | 60.63           | 909.47           | test             |
| 1.00      | 0.92                  | 0.01            | 1     | 10.11           | 10.11            | some_other_test  |
| 0.00      | 0.92                  | 0.00            | 1     | 0.00            | 848.84           | another_test     |

gprof can be also used for showing the call graph statistics

```
$ gprof -q <executable> gmon.out
```

The uftrace tool is to trace and analyze execution of a program written in C/C++

Website: [github.com/namhyung/uftrace](https://github.com/namhyung/uftrace)

```
$ gcc -pg <program>.cpp
$ uftrace record <executable>
$ uftrace replay
```

Flame graph output in html and svg

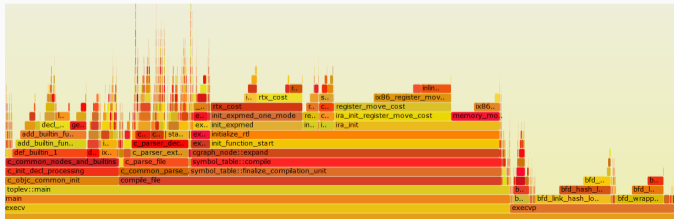

`callgrind` is a profiling tool that records the call history among functions in a program's run as a call-graph. By default, the collected data consists of the number of instructions executed

Website: [valgrind.org/docs/manual/cl-manual.html](http://valgrind.org/docs/manual/cl-manual.html)

## Usage:

- Profile the application with `callgrind`

```
$ valgrind --tool callgrind <executable> <args>
```

- Inspect `callgrind.out.XXX` file, where `XXX` will be the process identifier

`cachegrind` simulates how your program interacts with a machine's cache hierarchy and (optionally) branch predictor

Website: [valgrind.org/docs/manual/cg-manual.html](http://valgrind.org/docs/manual/cg-manual.html)

## Usage:

- Profile the application with `cachegrind`

```
$ valgrind --tool cachegrind --branch-sim=yes <executable> <args>
```

- Inspect the output (cache misses and rate)
  - **I1** L1 instruction cache
  - **D1** L1 data cache
  - **LL** Last level cache

# kcachegrind and qcachegrindwin (View)

KCachegrind (linux) and Qcachegrind (windows) provide a graphical interface for browsing the performance results of callgraph

- [kcachegrind.sourceforge.net/html/Home.html](http://kcachegrind.sourceforge.net/html/Home.html)
- [sourceforge.net/projects/qcachegrindwin](http://sourceforge.net/projects/qcachegrindwin)

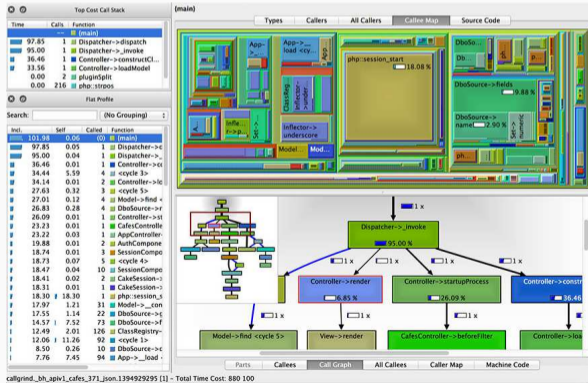

# gprof2dot (View)

gprof2dot is a Python script to convert the output from many profilers into a dot graph

Website: [github.com/jrfonseca/gprof2dot](https://github.com/jrfonseca/gprof2dot)

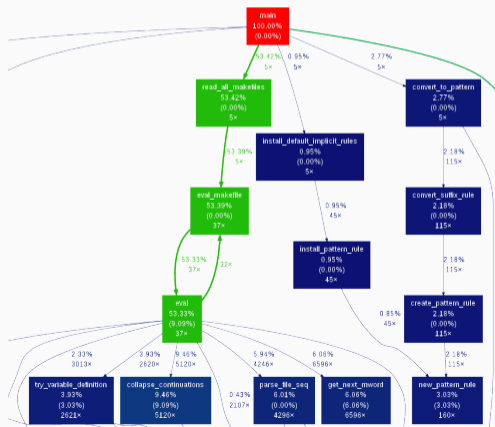

Perf is performance monitoring and analysis tool for Linux. It uses statistical profiling, where it polls the program and sees what function is working

Website: [perf.wiki.kernel.org/index.php/Main\\_Page](http://perf.wiki.kernel.org/index.php/Main_Page)

```
$ perf record -g <executable> <args> // or
$ perf record --call-graph dwarf <executable>
$ perf report // or
$ perf report -g graph --no-children
```

| # | Overhead | Command | Shared Object     | Symbol                    |
|---|----------|---------|-------------------|---------------------------|
| # | .....    | .....   | .....             | .....                     |
| # |          |         |                   |                           |
|   | 86.79%   | dd      | [kernel.kallsyms] | [k] common_file_perm      |
|   | 11.41%   | dd      | perf_3.2.0-23     | [.] memcpy                |
|   | 1.80%    | dd      | [kernel.kallsyms] | [k] native_write_msr_safe |

Data collected by perf can be visualized by using flame graphs, see:

Speedscope: visualize what your program is doing and where it is spending time

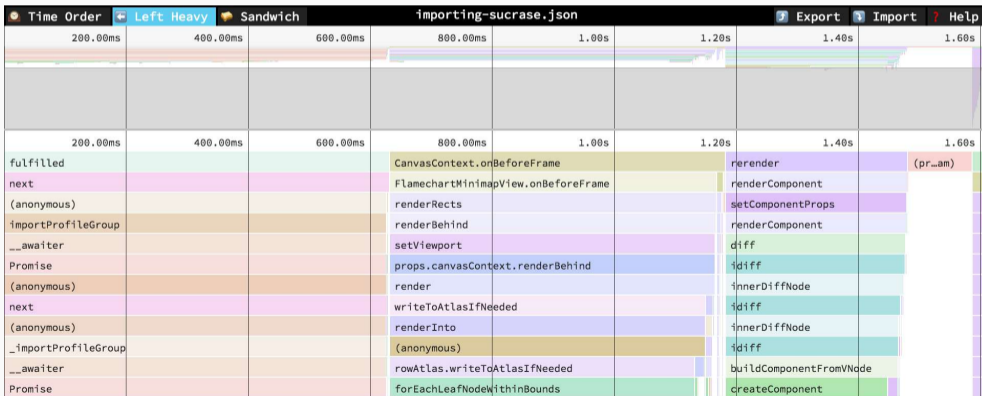



## Other Profilers

Free profiler:

- Hotspot

Proprietary profiler:

- Intel VTune
- AMD CodeAnalyst

# Parallel Computing

---

# Concurrency vs. Parallelism

## Concurrency

A system is said to be **concurrent** if it can support two or more actions in progress at the same time. Multiple processing units work on different tasks independently

## Parallelism

A system is said to be **parallel** if it can support two or more actions executing simultaneously. Multiple processing units work on the same problem and their interaction can effect the final result

Note: parallel computation requires rethinking original sequential algorithms (e.g. avoid race conditions)

# Performance Scaling

## Strong Scaling

The **strong scaling** defined how the compute time decreases increasing the number of processors for a fixed total problem size

## Weak Scaling

The **weak scaling** defined how the compute time decrease increasing the number of processors for a fixed total problem size per processor

*Strong scaling* is hard to achieve because of computation units communication. *Strong scaling* is in contrast to the Amdahl's Law

# Gustafson's Law

## Gustafson's Law

Increasing number of processor units allow solving larger problems in the same time (the computation time is constant)

Multiple problem instances can run concurrently with more computational resources

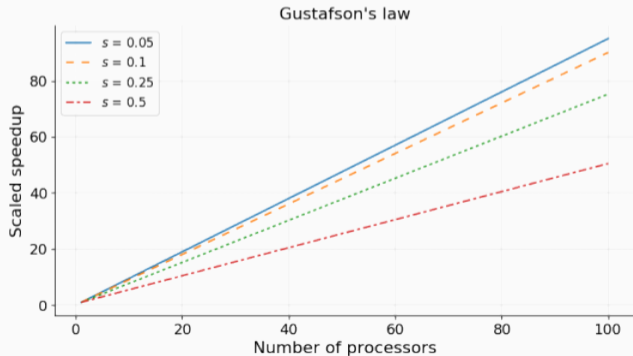

**C++11 Threads** (+ Parallel STL) free, multi-core CPUs

**OpenMP** free, directive-based, multi-core CPUs and GPUs (last versions)

**OpenACC** free, directive-based, multi-core CPUs and GPUs

**Khronos OpenCL** free, multi-core CPUs, GPUs, FPGA

**Nvidia CUDA** free, Nvidia GPUs

**AMD ROCm** free, AMD GPUs

**HIP** free, heterogeneous-compute Interface for AMD/Nvidia GPUs

**Khronos SyCL** free, abstraction layer for OpenCL, OpenMP, C/C++ libraries, multi-core CPUs and GPUs

**KoKKos (Sandia)** free, abstraction layer for multi-core CPUs and GPUs

**Raja (LLNL)** free, abstraction layer for multi-core CPUs and GPUs

**Intel TBB** commercial, multi-core CPUs

**OneAPI** free, Data Parallel C++ (DPC++) built upon C++ and SYCL, CPUs, GPUs, FPGA, accelerators

**MPI** free, de-facto standard for distributed system

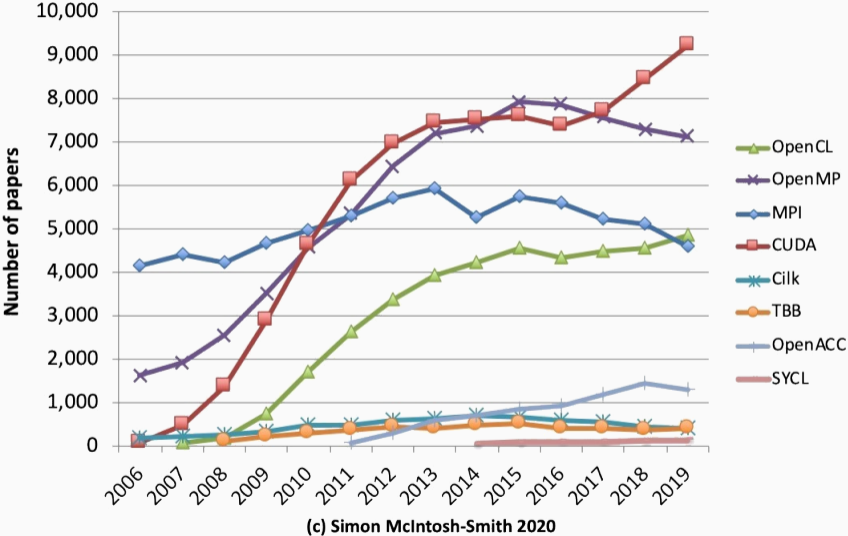

(c) Simon McIntosh-Smith 2020



## A Nice Example

Accelerates computational chemistry simulations from 14 hours to 47 seconds with OpenACC on GPUs ( $\sim 1,000\times$  Speedup)

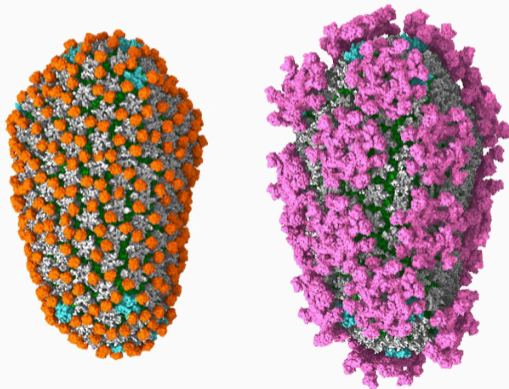

# Modern C++ Programming

## 23. SOFTWARE DESIGN I [DRAFT]

### BASIC CONCEPTS

---

*Federico Busato*

2024-11-05

## **1** Books and References

## **2** Basic Concepts

- Abstraction, Interface, and Module
- Class Invariant

## **3** Software Design Principles

- Separation of Concern
- Low Coupling, High Cohesion
- Encapsulation and Information Hiding
- Design by Contract
- Problem Decomposition
- Code reuse

## **4** Software Complexity

- Software Entropy
- Technical Debt

## **5** The SOLID Design Principles

## **6** Class Design

- The Class Interface Principle
- Member Functions vs. Free Functions
- Namespace Functions vs. Class static Methods

## **7** BLAS GEMM Case Study

## **8** Owning Objects and Views

**9** Value vs. Reference Semantic

**10** Global Variables

# Books and References

---

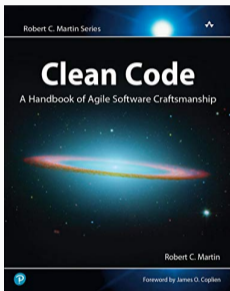

**Clean Code: A Handbook of Agile  
Software Craftsmanship**  
*Robert C. Martin, 2008*

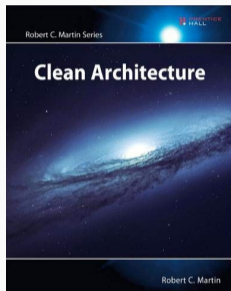

**Clean Architecture**  
*Robert C. Martin, 2017*



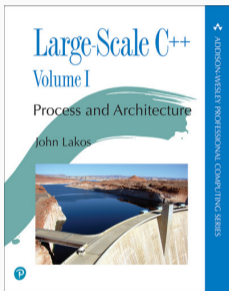

**Large-Scale C++ Volume I: Process and Architecture**  
*J. Lakos, 2021*

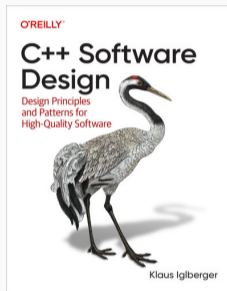

**C++ Software Design**  
*K. Iglberger, 2022*

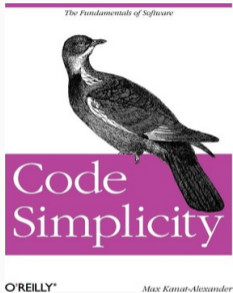

## Code Simplicity

*M. Kanat-Alexander, 2012*

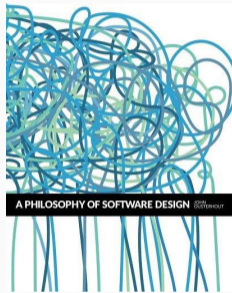

## A Philosophy of Software Design (2nd)

*J. Ousterhout, 2021*

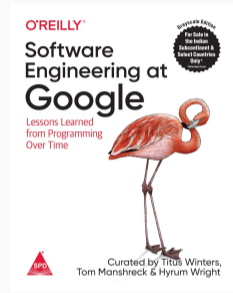

## Software Engineering at Google: Lessons Learned from Programming over Time

*T. Winters, 2020*

(download link)

# Basic Concepts

---

# Abstraction, Interface, Module, and Class Invariant

An **abstraction** is the process of *generalizing relevant information and behavior* (semantics) from concrete details

An **interface** is a communication point that allows interactions between users and the system. It aims to *standardize* and *simplify* the use of programs

A **module** is a software component that provides a specific functionality. Common examples are classes, files, and libraries

*“In modular programming, each **module** provides an **abstraction** in form of its **interface**”*

– John Ousterhout, *A Philosophy of Software Design*

*“Most modules have more users than developers, so it is better for the developers to suffer than the users... **it is more important for a module to have a simple interface than a simple implementation**”*

– John Ousterhout, *A Philosophy of Software Design*

*“The key to **designing abstractions** is to understand what is important, and to look for designs that **minimize the amount of information that is important**”*

– John Ousterhout, *A Philosophy of Software Design*

# Class Invariant

A class invariant (or **type invariant**) is a *property* of an object which remains unchanged after operations or transformations. In other words, *a set of conditions that hold throughout its life*. A *class invariant* constrains the object state and describes its behavior

# Software Design Principles

---

“Separation of concern” suggests to organize software in **modules**, each of which address a separate “concern” or functionality

Benefits of a modular design includes

- *Decrease cognitive load.* Small consistent parts are easier to understand than the whole system in its entirety
- *Help code maintainability.* Fewer or no dependencies allow to focus on smaller pieces of code, isolate potential bugs, and minimize the impact of changes
- *Independent development*

Modular design can be achieved both with *vertical* and *horizontal* organization, i.e. layers of abstractions or functionalities at the same level



*“The most fundamental problem in computer science is **problem decomposition**: how to take a complex problem and divide it up into pieces that can be solved independently”*

– **John Ousterhout**, *A Philosophy of Software Design*

*“We want to design components that are self-contained: independent, and with a single, well-defined purpose”*

– **Andy Hunt**, *The Pragmatic Programmer*

## Low Coupling, High Cohesion

**Cohesion** refers to the degree to which the elements inside a module belong together.

In other words, the code that changes together, stays together.

See also the *Single Responsibility Principle*

**Coupling** refers to the degree of interdependence between software modules. In other words, how a modification in one module affects changes in other modules

The **Low Coupling, High Cohesion** principle suggests to minimize dependencies and keep together code that is part of the same functionality

# Encapsulation and Information Hiding

Encapsulation refers to grouping together related data and methods that operate on the data. It allows to present a consistent interface that is independent of its internal implementation

*Encapsulation* is usually associated with the concept of information hiding that prevents

- Exposing implementation details
- Violating *class invariant* maintained by the methods

It also provides freedom for the internal implementations

Encapsulation and information hiding are common paradigms to achieve *software modularity*

*“Generic programming depends on the decomposition of programs into components which may be developed separately and combined arbitrarily, subject only to well-defined interfaces”*

– **James C. Dehnert and Alexander Stepanov**

*Fundamentals of Generic Programming* ↗

*“Code reuse is the Holy Grail of Software Engineering”*  
– **Douglas Crockford**, *Developer of the JavaScript language*

# Software Complexity

---

*“Technical debt is most often caused not so much by developers taking shortcuts, but rather by management who pushes velocity over quality, features over simplicity”*

– **Grady Booch**, *UML/Design Pattern*

*“Simplicity is the ultimate sophistication”*

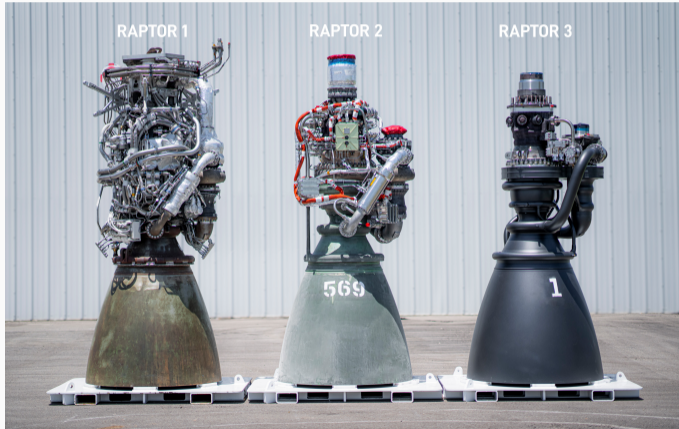



# The SOLID Design Principles

---

# Class Design

---

# The Class Interface Principle

## The Interface Principle

For a class `X`, all functions, including free functions, that both

- “mention” `X`, and
- are “supplied with” `X`

are logically part of `X`, because they form part of the interface of `X`

If you put a class into a namespace, be sure to put all helper functions and operators into the same namespace too

---

Using namespaces effectively

What's In a Class? - The Interface Principle

## Why Prefer Non-Member Functions

**Encapsulation:** *Non-member functions* guarantee to preserve the class invariant as they can only call public methods, protecting the class state by definition.

*Non-member functions* helps to keep the class smaller and simpler → easier to maintain and safer

*Member functions* induce **coupling** forcing the dependency from the `this` pointer.

*Member functions* can be split or organized in several other functions, worsening the problem. Such methods are forced to perform actions that are only specific to such class. On the contrary, non-member function favor generic code and can be potentially reused across the program

## Why Prefer Non-Member Functions

**Cohesion/Single Responsibility Principle** *Member functions* can perform actions that are not strictly required by the class, bloating its semantics

**Open-Close Principle** *Non-member functions* improve the flexibility and extensibility of classes by extending its functionality but without

## Member Functions vs. Free Functions

*“If you’re writing a function that can be implemented as either a member or as a non-friend non-member, you should prefer to implement it as a non-member function. That decision increases class encapsulation. When you think encapsulation, you should think non-member functions”*

– **Scott Meyers**, *Effective C++*

- 
- <https://workat.tech/machine-coding/tutorial/design-good-functions-classes-clean-code-86h68awn9c7q>
  - Prefer nonmember, nonfriends?
  - Monoliths "Unstrung",
  - How Non-Member Functions Improve Encapsulation
  - C++ Core Guidelines - C.4: Make a function a member only if it needs direct access to the representation of a class
  - Functions Want To Be Free, David Stone, CppNow15
  - Free your functions!, Klaus Iglberger, Meeting C++ 2017

# Member Functions

## Functions that must be *member* (C++ standard):

- Constructors, destructor, e.g. `A()` , `~A()`
- Assignment operators, e.g. `operator=(const A&)`
- Subscript operators, `operator[]()`
- Arrow operators, `operator->()`
- Conversion operators, `operator B()`
- Function call operator, `operator()`
- Virtual functions, `virtual f()`

# Member Functions

## Functions strongly suggested being *member*:

- **Unary operators** because they don't interact with other entities
  - Member access operators: dereferencing `*a` , address-of `&a`
  - Increment, decrement operators: `a++` `--a`
- Any **method that preserves**
  - **const correctness**, e.g. pointer access
  - **object initialization state**, e.g. a variable that cannot be changed externally after initialization (invariant)

## Functions suggested being member:

- In general, **compound operators** are expressed by updating private data members `operator+=(T, T)` , `operator|=(T, T)` , etc.



# Non-Member Functions

Functions that must be *non-member* (C++ standard):

- Stream extraction and insertion `<<`, `>>`

Functions that are strongly suggested being *non-member*:

- Binary operators to maintain symmetry, see also “Implicit conversion and overloading”

`operator+(T, T)`, `operator|(T, T)`, etc.

- Template functions within a class template

Otherwise, it requires an additional `template` keyword when calling the function (see *dependent typename*) → verbose, error-prone

---

Effective C++ item 24: Declare Non-member Functions When Type Conversions Should Apply to All Parameters

## Member Functions vs. Free Functions - Summary

More in general, *member functions* should be used only to **preserve the invariant properties** of a class and cannot be efficiently implemented in terms of other **public methods**

All other functions are suggested to be *free-functions*

Some examples: `std::begin()/std::end()` C++14, `std::size()` C++17

# Namespace Functions vs. Class static Methods

## Namespace functions:

- Namespace can be extended anywhere (without control)
- Namespace specifier can be avoided with the keyword `using`

## Class + `static` methods:

- Can interact only with static data members
- `struct/class` cannot be extended outside their declarations

→ `static` methods should define operations strictly related to an object state (*statefull*)

→ otherwise `namespace` should be preferred (*stateless*)

# BLAS GEMM Case Study

---

# BLAS GEMM

**GE**neralized **MA**trix-**MA**trix product API provided by **BA**sic **L**inear **AL**gebra **S**ubroutine standard is one of the most used function in scientific computing and artificial intelligence

The API is defined in C as follow:  $C = \alpha op(A) * op(B) + \beta C$

```
GLenum sgemm(int m, int n, int k,
 OperationEnum opA,
 OperationEnum opB,
 float alpha,
 float* a,
 int lda,
 float* b,
 int ldb,
 float beta,
 float* c,
 int ldc);
```

## BLAS GEMM - Comprehension Problems

- `m`, `n`, `k` describe the shapes of `A`, `B`, `C` in a non-intuitive way. Except domain-expert, users prefer providing the number of rows and columns as matrix properties, not GEMM problem properties
- **Privatization of the return channel** for providing errors
- **Errors expressed with enumerators.** Need additional API to get a description of the error meaning
- **Domain-specific cryptic name.** e.g. `zgemm`: generalized matrix-matrix multiplication with double-precision complex type
- **The data type on which the function operates is encoded in the name itself** `zgemm` → any new combination of data types requires a new name.

- `A`, `B`, `C` matrices could have different types
- The compute type, namely the type of intermediate operations, could be different from the matrices. This is also known as *mixed-precision* computation
- Batched computation, namely having multiple input/output matrices, is not supported
- The API is **state-less** → preprocessing steps for optimization or additional properties (e.g. different algorithms) cannot be expressed
- Matrix sizes can be greater than `int` ( $2^{31} - 1$ ), specially on distributed systems
- Even if we perform computations with relative small matrices, the strides, e.g. `row * lda` could be larger than `int` ( $2^{31} - 1$ )

- `alpha/beta` could have a different type from matrix types
- `alpha/beta` are typically pointers on accelerators (e.g. GPU) to allow asynchronous computation
- The underlying memory layout is implicit (column-major). Row-major and other layouts are not supported
- `C` is both input and output. It is more flexible to decouple `C` and add another parameter for the output `D`
- Doesn't have an *execution policy* which describes *where* (host, device) and *how* (sequential, parallel, vectorized, etc.)



- Doesn't have a *memory resource* which provides a mechanism to manage internal memory
- *Memory alignment* is known only at run-time
- It is not possible to optimize the execution with compile-time matrix sizes

*Most of all these points have been addressed by the `std::linalg` [proposal](#)*

# Owning Objects and Views

---

# Objects vs. View

## Object

An **object** is a representation of a *concrete entity as a value in memory*

## Resource-owning object

**Resource-owning object** refers to RAII paradigm which ties resources to object lifetime

example: `std::vector`, `std::string`

## View

A **view** acts as a *non-owning reference* and does not manage the storage that it refers to. Lifetime management is up to the user

example: `std::span`, `std::mdspan`, `std::string_view`

## Objects vs. View

- lack ownership
- short-lived
- generally appear only in function parameters
- generally cannot be stored in data structures
- generally cannot be returned safely from functions (no ownership semantics)

# Objects vs. View

```
#include <string>
#include <string_view>

std::string f() { return "abc"; }

void g(std::string_view sv) {}

std::string_view x = f(); // memory leak
g(f()); // memory leak
```

---

Regular, Revisited, *Victor Ciura*, CppCon23

# **Value vs. Reference**

## **Semantic**

---

**Technical Debt:** engineering cost: more coupled, more rigid, fragile (multiple references)

**Spooky action:** different references see an implicitly shared object. Modification to a reference affects the other ones

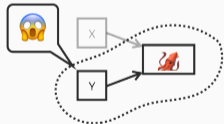

**Incidental algorithms:** emerges from a composition of locally defined behaviors and with no explicit encoding in the program. References are connection between dynamic objects

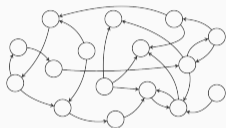

**Visibility broken invariant:** a modification to a reference can have a chain of actions that reflects to the original object, breaking the visibility of an action

**Race conditions:** spooky action between different threads

Values - Safety, Regularity, Independence, and the Future of Programming, *Dave Abrahams*, CppCon22



**Surprise mutation:** invisible coupling introduced by involuntary dependencies

```
void offset(int& x, const int& delta) { x += delta;}

int a = 3;
offset(a, a); // x=6, delta=6
offset(a, a); // x=12, delta=12
```

**Unsafe operations mutation:** A safe operation cannot cause undefined behavior

```
int a = 3;
int b& = a;
a = b++;
```

see also, ~~strict aliasing violation~~

Property Models: From Incidental Algorithms to Reusable Components, *Jarvi et al*,  
GPCE'08

**Regularity:**  $x = x$ ;  $x == y \rightarrow y == x$ ;  $x == \text{copy}(x)$ ;  $x = y \iff x = \text{copy}(x)$

regular data type properties: copying, equality, hashing, comparison, assignment, serialization, differentiation

composition of value type is a value type

**Independence:** local and thread-safe

### value semantic in C++

- pass-by-value gives callee an independent value
- a return value is independent in the caller
- a rvalue is independent

# Global Variables

---

The Problems with Global Variables

# Modern C++ Programming

## 24. SOFTWARE DESIGN II [DRAFT]

### DESIGN PATTERNS AND IDIOMS

---

*Federico Busato*

2024-11-05

## 1 C++ Idioms

- Rule of Zero
- Rule of Three
- Rule of Five

## 2 Design Pattern

- Singleton
- Pointer to IMPLementation (PIMPL)
- Curiously Recurring Template Pattern
- Template Virtual Functions

# C++ Idioms

---

# Rule of Zero

The **Rule of Zero** is a rule of thumb for C++

Utilize the *value semantics* of existing types to avoid having to implement *custom* copy and move operations

**Note:** many classes (such as `std` classes) manage resources themselves and should not implement copy/move constructor and assignment operator

```
class X {
public:
 X(...); // constructor
 // NO need to define copy/move semantic
private:
 std::vector<int> v; // instead raw allocation
 std::unique_ptr<int> p; // instead raw allocation
}; // see smart pointer
```



## Rule of Three

The **Rule of Three** is a rule of thumb for C++(03)

If your class needs any of

- a copy constructor `X(const X&)`
- an assignment operator `X& operator=(const X&)`
- or a destructor `~X()`

defined explicitly, then it is likely to need all three of them

Some resources cannot or should not be copied. In this case, they should be declared as deleted

```
X(const X&) = delete
```

```
X& operator=(const X&) = delete
```

# Rule of Five

The **Rule of Five** is a rule of thumb for C++11

If your class needs any of

- a copy constructor `X(const X&)`
- a move constructor `X(X&&)`
- an assignment operator `X& operator=(const X&)`
- an assignment operator `X& operator=(X&&)`
- or a destructor `~X()`

defined explicitly, then it is likely to need all five of them

# Design Pattern

---

# Singleton

**Singleton** is a software design pattern that restricts the instantiation of a class to one and only one object (a common application is for logging)

```
class Singleton {
public:
 static Singleton& get_instance() { // note "static"
 static Singleton instance { ..init.. } ;
 return instance; // destroyed at the end of the program
 } // initilized at first use

 Singleton(const& Singleton) = delete;
 void operator=(const& Singleton) = delete;

 void f() {}
private:
 T _data;

 Singleton(..args..) { ... } // used in the initialization
}
```

## Pointer to IMPLementation (PIMPL) - Compilation Firewalls

**Pointer to IMPLementation (PIMPL)** idiom allows decoupling the interface from the implementation in a clear way

header.hpp

```
class A {
public:
 A();
 ~A();
 void f();
private:
 class Impl; // forward declaration
 Impl* ptr; // opaque pointer
};
```

NOTE: The class does not expose internal data members or methods

# PIMPL - Implementation

source.cpp (Impl actual implementation)

```
class A::Impl { // could be a class with a complex logic
public:
 void internal_f() {
 ..do something..
 }
private:
 int _data1;
 float _data2;
};

A::A() : ptr{new Impl()} {}
A::~~A() { delete ptr; }
void A::f() { ptr->internal_f(); }
```

# PIMPL - Advantages, Disadvantages

## Advantages:

- ABI stability
- Hide private data members and methods
- Reduce compile time and dependencies

## Disadvantages:

- Manual resource management
  - `Impl* ptr` can be replaced by `unique_ptr<impl> ptr` in C++11
- Performance: pointer indirection + dynamic memory
  - dynamic memory could be avoided by using a reserved space in the interface e.g. `uint8_t data[1024]`

## PIMPL - Implementation Alternatives

What parts of the class should go into the `Impl` object?

- *Put all private and protected members into `Impl`:*  
**Error prone.** Inheritance is hard for opaque objects
- *Put all private members (but not functions) into `Impl`:*  
**Good.** Do we need to expose all functions?
- *Put everything into `Impl`, and write the public class itself as only the public interface, each implemented as a simple forwarding function:*  
**Good**



The **Curiously Recurring Template Pattern (CRTP)** is an idiom in which a class `X` derives from a class template instantiation using `X` itself as template argument

A common application is *static polymorphism*

```
template <class T>
struct Base {
 void my_method() {
 static_cast<T*>(this)->my_method_impl();
 }
};

class Derived : public Base<Derived> {
 // void my_method() is inherited
 void my_method_impl() { ... } // private method
};
```

```
#include <iostream>
template <typename T>
struct Writer {
 void write(const char* str) {
 static_cast<const T*>(this)->write_impl(str);
 }
};

class CerrWriter : public Writer<CerrWriter> {
 void write_impl(const char* str) { std::cerr << str; }
};

class CoutWriter : public Writer<CoutWriter> {
 void write_impl(const char* str) { std::cout << str; }
};

CoutWriter x;
CerrWriter y;
x.write("abc");
y.write("abc");
```

```
template <typename T>
void f(Writer<T>& writer) {
 writer.write("abc");
}
```

```
CoutWriter x;
CerrWriter y;
f(x);
f(y);
```

**Virtual functions cannot have template arguments**, but they can be emulated by using the following pattern

```
class Base {
public:
 template<typename T>
 void method(T t) {
 v_method(t); // call the actual implementation
 }
protected:
 virtual void v_method(int t) = 0; // v_method is valid only
 virtual void v_method(double t) = 0; // for "int" and "double"
};
```

Actual implementations for derived class `A` and `B`

```
class AImpl : public Base {
protected:
 template<typename T>
 void t_method(T t) { // template "method()" implementation for A
 std::cout << "A " << t << std::endl;
 }
};

class BImpl : public Base {
protected:
 template<typename T>
 void t_method(T t) { // template "method()" implementation for B
 std::cout << "B " << t << std::endl;
 }
};
```

```
template<class Impl>
class DerivedWrapper : public Impl {
private:
 void v_method(int t) override {
 Impl::t_method(t);
 }
 void v_method(double t) override {
 Impl::t_method(t);
 } // call the base method
};

using A = DerivedWrapper<AImpl>;
using B = DerivedWrapper<BImpl>;
```

```
int main(int argc, char* argv[]) {
 A a;
 B b;
 Base* base = nullptr;

 base = &a;
 base->method(1); // print "A 1"
 base->method(2.0); // print "A 2.0"

 base = &b;
 base->method(1); // print "B 1"
 base->method(2.0); // print "B 2.0"
}
```

`method()` calls `v_method()` (pure virtual method of `Base`)

`v_method()` calls `t_method()` (actual implementation)